



Science Arts & Métiers (SAM)

is an open access repository that collects the work of Arts et Métiers Institute of Technology researchers and makes it freely available over the web where possible.

This is an author-deposited version published in: <https://sam.ensam.eu>
Handle ID: <http://hdl.handle.net/10985/8360>

To cite this version :

Chafik LABIDI, Jean-Pierre FERREIRA-MARTIN, Mohamed Abdou DJOUADI, Corinne NOUVEAU, Robert COLLET - Application of CrAIN coatings on carbide substrates in routing of MDF - Wear - Vol. 263, p.1291-1299 - 2007

Any correspondence concerning this service should be sent to the repository

Administrator : scienceouverte@ensam.eu



Application of CrAlN coatings on carbide substrates in routing of MDF

C. Nouveau^{a,*}, C. Labidi^a, J.-P. Ferreira Martin^b, R. Collet^a, A. Djouadi^c

^a LaBoMaP, ENSAM, Rue Porte de Paris, F-71250 Cluny, France

^b ISOROY, Paris, France

^c Institut des Matériaux Jean Rouxel, UMR 6502, 2 rue de la Houssinière, B.P. 32229, F-44322 Nantes Cedex 3, France

Abstract

This study deals with the development of Chromium Aluminium Nitride (CrAlN) hard coatings (by varying the nitrogen content in the plasma, the target bias voltage, the working pressure and the deposition time) and their characterization by physical and mechanical techniques (XRD, nanoindentation, Young's modulus, stress, scratch-test, composition, etc.) in order to determine the optimal deposition conditions to apply the coatings to carbide substrates.

Moreover, in order to improve the adhesion of the same optimal hard coatings and as it was efficient with Diamond Like Carbon (DLC) coatings, we tried to modify the carbide inserts by chemical attacks with Murakami's agent before machining.

The coated tools (with and without Murakami's attack) were then tested in routing of Medium Density Fibreboard (MDF). A comparison of the abrasion and shock resistance of the conventional tools with the treated ones, was made. The efficiency of Murakami's agent was also studied. It was obvious that the coated carbide tools had greater tool life than the untreated ones. Besides, Murakami's attack was not optimized or not a solution to improve the adhesion of nitride coatings on carbide inserts.

Keywords: CrAlN; Magnetron sputtering; Routing; MDF; Murakami; Abrasion and shock resistance

1. Introduction

Nowadays, hard coatings are commonly used to increase the wear resistance of cutting tools in metal machining [1]. In wood machining, the application of coatings as wear or corrosion protection of cutting knives is not common, though previous works [2,3] have shown their potential in peeling and routing. Even if the coatings caused an increase in the service life of the cutting tools, their adhesion was not sufficient especially on carbide inserts. This could limit their use. Nevertheless, the solution to increase the adhesion of hard coatings such as CrAlN on carbide substrates could be a surface preparing by the Murakami's agent which showed an improvement of the adhesion of Diamond Like Carbon coatings in other studies [4]. The aim of this work was first to develop CrAlN layers with optimal physical and mechanical properties to apply them to carbide inserts.

The coatings were then tested by routing MDF with carbides previously attacked or not with Murakami's agent.

2. Experimental details

2.1. Treatments and characterizations

The deposition of the CrAlN coatings was carried out by a dual RF magnetron sputtering system (NORDIKO type 3500–1356 MHz). A pure sintered CrAl target was used (25% at of Al in weight). We studied the variation of parameters such as the nitrogen content in the plasma (10, 17.5, 25, 35, 50 and 100%), the working pressure (2, 4, 8 and 12 μ bar), the target voltage (–300, –500, –700 and –900 V) and the deposition time (60, 90, 120, 180 and 240 min). Different kinds of substrates were employed: silicon 10 mm \times 10 mm (for internal stress and thickness measurements), SiO₂ 10 mm \times 10 mm (for nanoindentation: NHT from CSM Instruments with a Berkovich indenter, sinus mode employed (1 Hz of frequency and 1 mN of amplitude), max load 10 mN, load and unload rate 5 mN/min)),

* Corresponding author. Tel.: +33 3 85 59 53 35; fax: +33 3 85 59 53 70.
E-mail address: nouveau@cluny.ensam.fr (C. Nouveau).

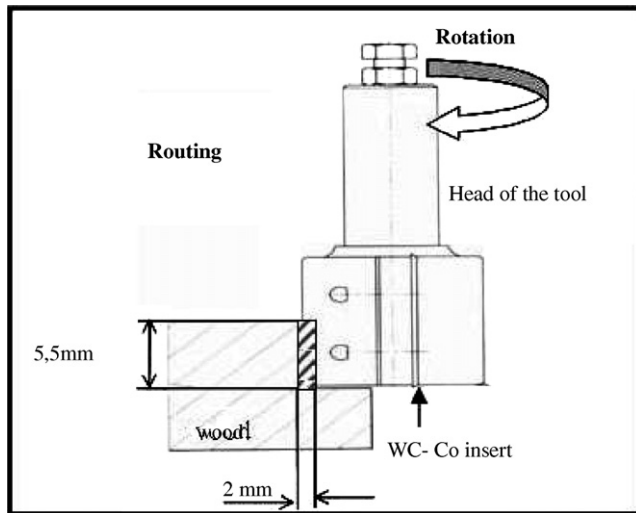

Fig. 1. Routing process principle.

Table 1
Routing parameters

Feed rate	$V_f = 15 \text{ m/min}$
Rotation rate	$N = 18,000 \text{ rpm} = 300 \text{ r/s}$
Tool diameter	$D = 40 \text{ mm}$
Number of tools	$Z = 2$ (a used carbide insert is placed opposed to our tested treated carbide to equilibrate the tool-holder)
Cutting rate	$V_c \approx 38 \text{ m/s}$
Radial engagement	$a_e = 2 \text{ mm}$
Axial engagement	$a_p = 5.5 \text{ mm}$
Feed per tool	$f_z = 0.83 \text{ mm/tool}$
Average thickness of the chip	$e = 0.19 \text{ mm}$
Machining mode	$90^\circ/0^\circ$
WC-Co carbide insert	LEITZ reference TM 405 0 (reversible insert with two cutting edges)
Edge angle	$\beta = 55^\circ$
Clearance angle	$\alpha = 10^\circ$
Linear cutting path machined per 1 MDF sample	$3 \times 57 \text{ m} = 171 \text{ m}$

90CMV8 steel samples frequently used for tools in wood machining [5] 20 mm × 20 mm to realize pin-on-disk tests and 10 mm × 10 mm for scratch-test (increasing load, Rockwell C indenter with an angle of 120° and a radius of 200 μm, linear load and constant displacement speed of the sample) and carbide inserts 50 mm × 12 mm × 1.5 mm (for the morphology, composition, structure by SEM + EDS (Jeol JSM-5900 LV) and crystallinity by XRD (SIEMENS D500, $K_{\alpha}(\text{Co})$ radiation)). The steel samples were ground with a roughness R_a of approximately 0.2 μm and R_t of approximately 1 μm to be similar to the carbide's roughness provided by LEITZ composed of 98% of WC and 2% of Co. All the substrates were ultrasonically cleaned in ethanol. Before deposition, the CrAl target and the samples were etched 5 min in an Ar plasma by RF and DC (−1000 V) discharges, respectively. The carbide tools were CrAlN-coated on both sides (thickness of 1–1.5 μm).

The attack by Murakami's agent ($\text{K}_3[\text{Fe}(\text{CN})_6]:\text{KOH}/\text{H}_2\text{O} = 1/1/10$) lasted 5 min and followed by ultrasonic cleaning of the carbides. The tools were then put into a $\text{H}_2\text{O}_2/\text{H}_2\text{SO}_4$ mixture for 5 s. After each bath, the substrates were rinsed in deionized

water. A final cleaning of 10 min in Hydro Fluoride acid (HF) in an ultrasonic bath permitted to remove some impurities observed after the attack (probably Co particles).

2.2. Wood machining tests

The experiment was performed using a three-axis industrial RECORD1 SCM S.p.A. CNC route. The routing process principle is shown in Fig. 1. The materials subjected to the cutting experiments were Medium Density Fibreboard (MDF) samples (600 mm × 197 mm × 19 mm) provided by ISOROY France. This composite material was chosen because of its high abrasive properties. The cutting parameters are summarized in Table 1 and Fig. 2 shows the tools' geometry and the tool-holder. The quantification of the wear of the cutting edge (called " V_b ") was evaluated according to the method defined in a previous study [6] and is represented in Fig. 3. Twenty measures were taken after each routing step and an average value of V_b was calculated.

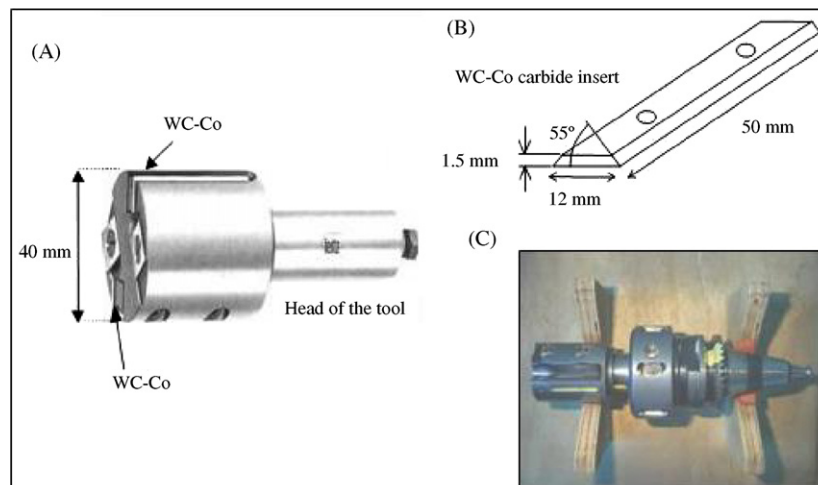

Fig. 2. (A) Tool; (B) carbide insert geometry (WC-Co); (C) tool-holder.

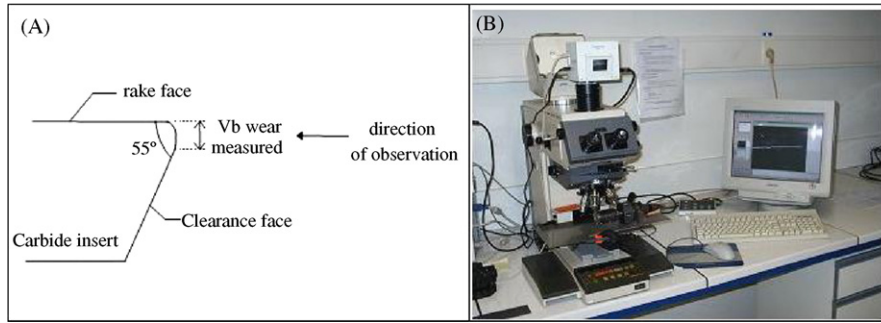

Fig. 3. (A) Quantification of the V_b wear of the cutting edge; (B) observation system (Olympus microscope and “ANALYSIS” software).

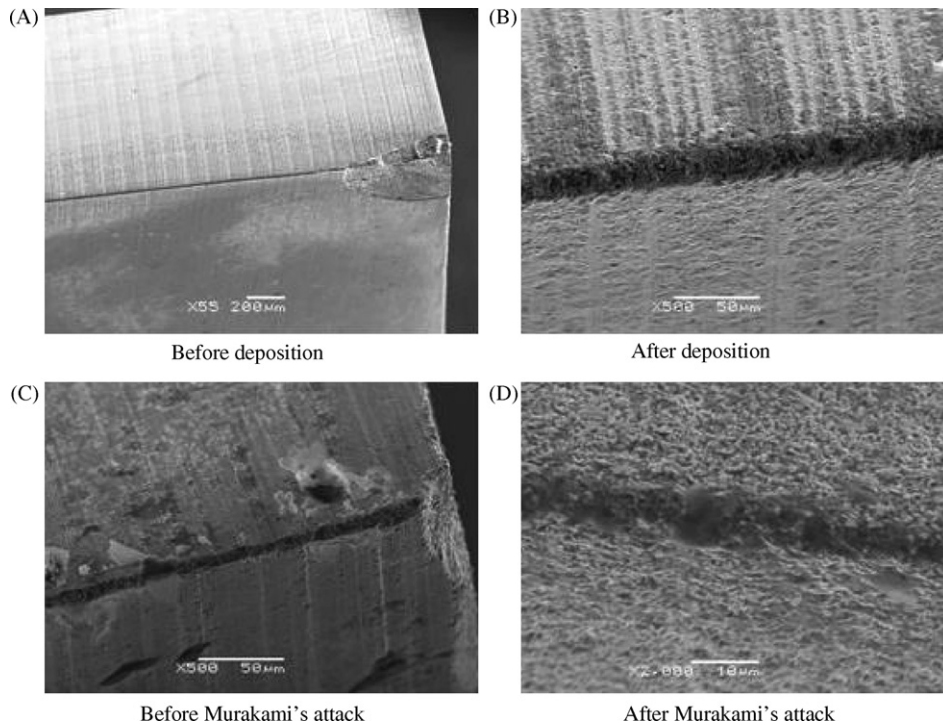

Fig. 4. SEM image of: (A) an uncoated and (B) CrAlN-coated carbide insert's edge; (C) an unattacked and (D) Murakami's attacked carbide insert's edge.

3. Results and discussion

3.1. Physico-chemical characterization of CrAlN coatings

3.1.1. Morphology by SEM

The condition of the edges of the carbide tooling provided by LEITZ was observed. Most of them were already damaged especially at the edges' corner as shown in Fig. 4A. It is obvious that the coating “follows” the roughness of the carbide substrate. In fact, we can still observe the grinding marks after deposition. On the cutting edge, the coatings made in two steps (clearance face and then rake face), are well superposed (Fig. 4B). As a consequence, the radius of the edge did not increase too much.

The influence of Murakami's attack is observed in Fig. 4C–D: the WC grains are clearly visible after attack, where the Co was dissolved, particularly near the cutting edge. This attests to the efficiency of this attack.

3.1.2. Composition's analysis by EDS

According to the EDS analysis, we obtained a constant atomic composition of 38% of N₂, 25% of Al, 25% of Cr and 10% of O₂ as shown in Fig. 5 above 15% of nitrogen in the plasma during the CrAlN layers deposition. The other deposition param-

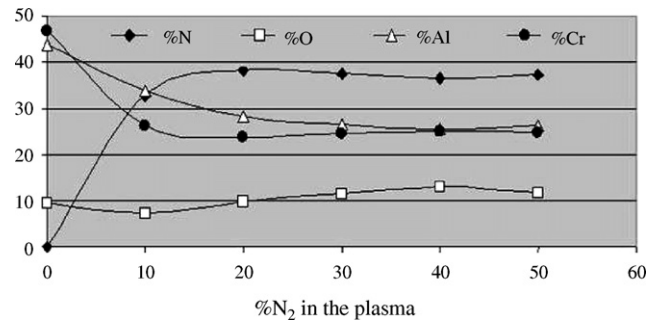

Fig. 5. EDS results of CrAlN coatings vs. the nitrogen content in the plasma.

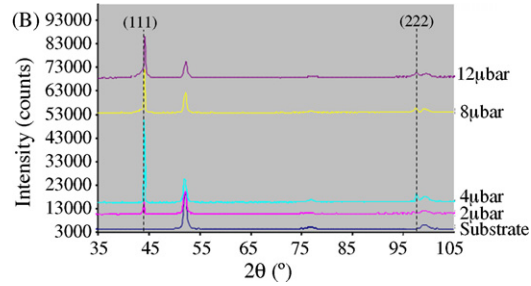
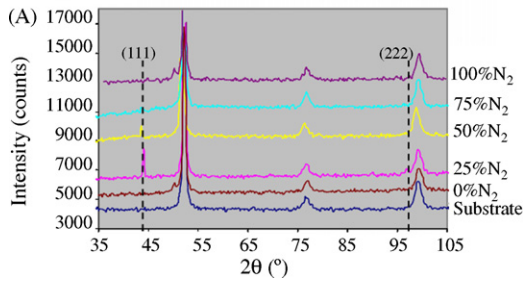

Fig. 6. XRD patterns of CrAlN coatings as a function of: (A) the nitrogen content in the plasma; (B) the working pressure.

eters (working pressure, deposition time, target voltage) had no influence on the coatings' composition.

3.1.3. Analyses by XRD

The XRD analyses were made on ground steel samples which presented a roughness similar to the one of the carbide inserts. This choice was justified by a previous study in which we observed the same structure of the coatings on steel and carbide substrates [6].

First, we studied the influence of the nitrogen content in the plasma: we observe a minor diffraction peak at 44° on the XRD patterns of Fig. 6A except for the coatings obtained with 25 and 50% of N_2 . In the case of the layer obtained with 25% of N_2 we have an intense and thin peak at 44° and a minor one at 98° not detected for the other nitrogen contents, which means that we have a well crystallized phase (CrN in an AlN matrix? AlN in a CrN matrix? Or a ternary, a quaternary system such as pure CrAlN or CrAlNO because of the presence of 10% of oxygen? Some complementary analyses (EBSD, XPS, SIMS in progress) are necessary to define the type of phase in presence. Above 25% of N_2 , the diffraction peaks are smaller and broader. This could be explained by the fact that higher nitrogen content interferes in the sputtering process and is negative for a good crystallinity. As a conclusion, to obtain well crystallized coatings, we have to work with nitrogen content around 25%.

We verified then the influence of the working pressure (Fig. 6B): only the intensity of the diffraction peaks at 44° and 98° varied. It seems that the optimal working pressure is $4 \mu\text{bar}$. When the pressure increases, there are a lot of species in the plasma and so the growth of the layers is disturbed because of the decrease of their rate and energy. Below $4 \mu\text{bar}$, contrarily, there are not enough species and the sputtering rate is decreased as well as the species energy necessary to obtain a well crystallized coating. In these cases, the layers are amorphous.

We also verified the influence of the thickness of the layers: as expected, it was obvious that thicker the layer was, the higher the intensity of the diffraction peak was. All the layers were well crystallized.

Finally, the influence of the target voltage was studied (Fig. 7): the optimal voltage is the highest one. Indeed, we observed that when the target voltage increases, the intensity of the diffraction peaks at 44° and 98° increases and the layers are more crystallized. When we work at lower voltage (-300 V), the layers are amorphous. The optimal target voltage is -900 V in our case.

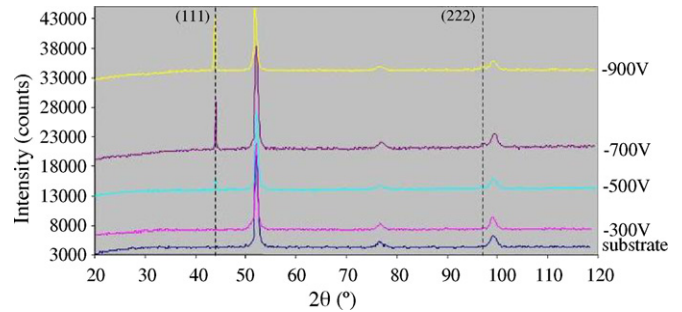

Fig. 7. XRD patterns of CrAlN coatings as a function of the target voltage.

3.2. Mechanical characterizations of CrAlN coatings

3.2.1. Stress and thickness

The stresses were determined by profilometry using Stoney's equation [6] and Newton's rings methods. It is worthy of note that only the method by profilometry permits to determine if the stress is in tension or compression. We applied the same sign to the stresses obtained by both methods.

We can observe in Fig. 8 that we obtained a similar behaviour with both methods: a curve presenting a different optimum (-4 GPa in the case of profilometry and -12 GPa in the case of Newton's rings method). Nevertheless, these results permit to determine an optimal time of deposition to get coatings with the lower stresses.

Below 40 min of deposition (layers 400 nm thick), the stresses are too high. As we are looking for a proper adhesion of the layers on cutting tools, we are also looking for the smallest stresses that means those obtained above 60 min (layers $> 600 \text{ nm}$ thick). Nouveau [6] obtained similar results for PVD CrN layers compared with TiN, c-BN, etc. and explained this behaviour in previous studies [6–8].

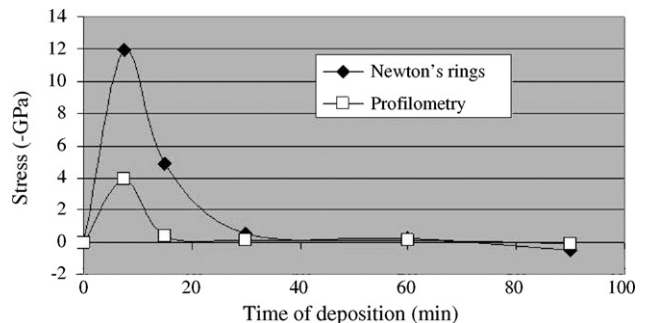

Fig. 8. Stress vs. the deposition time obtained with two methods.

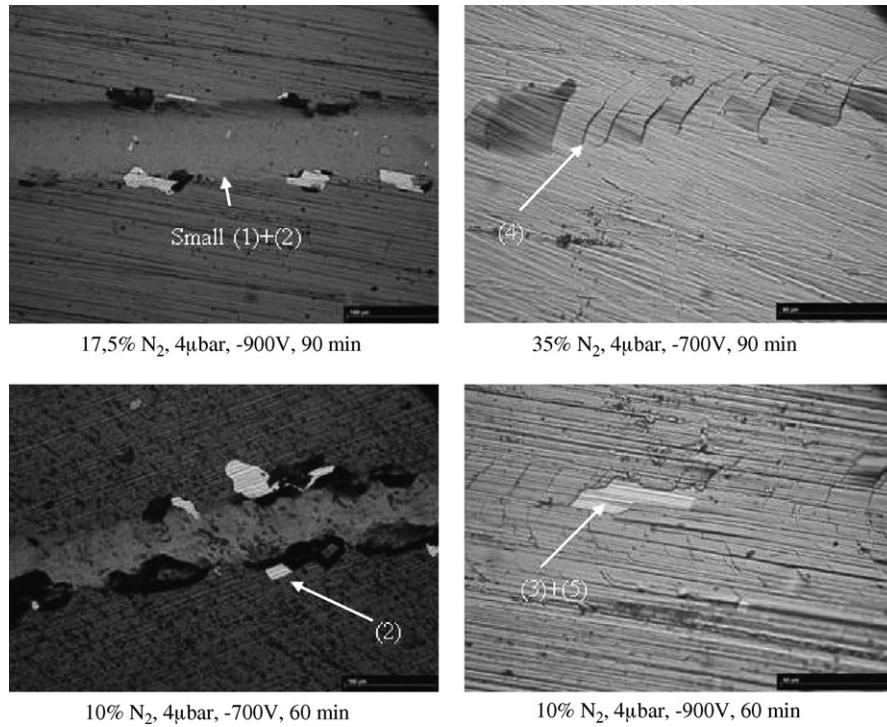

Fig. 9. Examples of damages after scratch-tests on CrAlN layers obtained in different deposition conditions.

3.2.2. Adhesion

The adhesion of the layers was studied by scratch-tests, SEM observations of the damages and calculation of the critical load L_{c2} . For all samples, four scratches were realized. Different kind of damages were observed: small scratches into the track (1), delamination at the side of the track (2), delamination into the

track (3), a beginning of a transversal scratch (4) and a transversal scratch, perpendicularly to the scratch direction (5). Some of these damages are represented in Fig. 9.

We observe in Fig. 10A that according to scratch-test, the most adherent layers are obtained for medium or low target voltages, which is not in accordance with the XRD results. We should

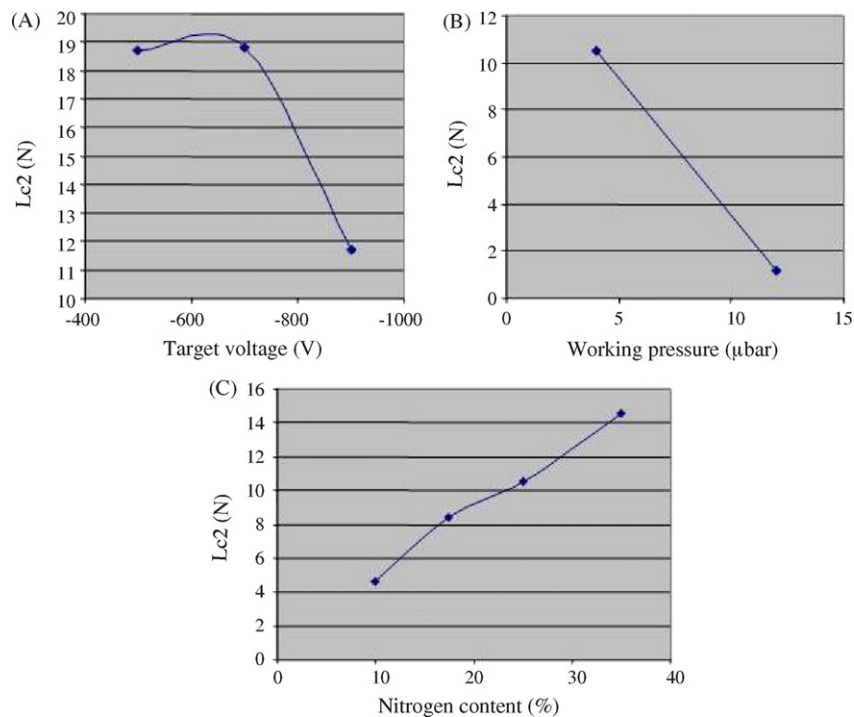

Fig. 10. Critical load L_{c2} as a function of: (A) the target voltage, (B) the working pressure and (C) the N_2 content in the plasma.

Table 2

Hardness and Young's modulus of CrAlN coatings

Working pressure (μbar)	Deposition time	Target voltage (V)	N ₂ content in the plasma (%)	Presputtering time (min)	Hardness (GPa)	Young's modulus E (GPa)
4	90	700	35	5	19.7	270
			17.5		22.7	365
			35		21.4	307
			17.5		23.5	402
8	90	900	25	30	8.2	153
12					6.4	121
4					20.3	283
					60	26.7
4	180	900	25	5	20.2	350
				5	25.8	315
					18.35	370

therefore find a compromise to get a well crystallized, hard and also adherent coatings. Besides, as in XRD, we see that the adhesion is better for lower working pressure (Fig. 10B). Indeed, for a high working pressure, the load needed to remove the coating from the substrate is almost zero which means that it is not at all adherent.

As the nitrogen content is concerned (Fig. 10C), we can conclude that higher it is, the better the adhesion of the layers is. Theoretically, we should work with the highest nitrogen content but according to the XRD and other results, good properties are obtained for around 25% of nitrogen, which content permits to get reasonable adherent and well crystallized layers.

3.2.3. Nanoindentation

The results are summarized in Table 2. We observe the influence of the working pressure, the nitrogen content and the target voltage. In fact, the lower the working pressure is, the higher the hardness and the Young's modulus of the layers are. These results are in accordance with the previous ones: working at low working pressure seems to be optimal. Nevertheless, we cannot work at 2 μbar because of an unstable RF discharge, that is why 4 μbar seems to be the optimal working pressure to obtain hard coatings with a reasonable Young's modulus.

Concerning the nitrogen content, it has a lower influence in comparison to the working pressure, on the hardness of the coatings. But it permits to improve it when it decreases to 10–20%. The improvement of the Young's modulus is obtained for a nitrogen content of 17.5% which is the same as the hardness.

These results tend to confirm the previous ones obtained by XRD where we determined an optimal nitrogen content around 25%: it seems now, that 17.5% of nitrogen is the optimal nitrogen content in the plasma.

The last parameter studied was the target voltage: whatever the deposition conditions, working at high target voltage (especially -900 V) permitted to obtain the highest hardness and Young's modulus. These results confirm the previous ones concerning the optimal target voltage to get coatings with good mechanical properties.

As a conclusion, the results obtained by nanoindentation confirm and complete the XRD analyses: when the layers are well crystallized, they are also hard. The optimal deposition condi-

tions to obtain well crystallized and hard coatings are a working pressure of 4 μbar , a nitrogen content of 17.5%–25% and a target voltage of -900 V .

3.3. Application in routing of MDF

First, we tested carbide inserts only CrAlN-coated to verify the efficiency of the layers in routing of MDF. Secondly, we tested the same carbide inserts but before the CrAlN deposition, they were attacked by Murakami's agent. Then, we studied the efficiency of this pre-treatment of the carbide on the coatings' adhesion in the same cutting conditions.

3.3.1. Routing of MDF with CrAlN-coated carbide inserts

During this study, we applied the previous determined optimized deposition conditions (4 μbar , 90 min, -900 V) but we also wanted to verify the influence of the nitrogen content on the abrasive wear resistance of the coatings in routing. The routing of MDF, a very abrasive composite, was then perfectly adapted.

We tested four different tools: an unmodified tool tested only on one edge, a CrAlN-coated tool with 10% of N₂ tested twice (on its both edges), a CrAlN-coated tool with 25% of N₂ tested twice (on its both edges) and a CrAlN-coated tool with 35% of N₂ tested only on one edge.

The results are summarized in Fig. 11. First, we can notice that the coated tools perform better than the unmodified one. We

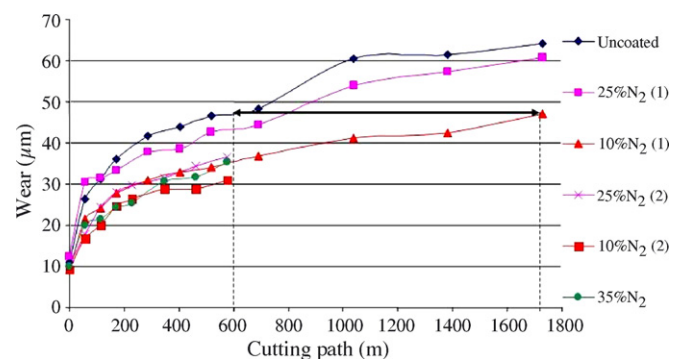

Fig. 11. Wear of the cutting edge vs. the cutting path in routing of MDF with CrAlN-coated carbide tools.

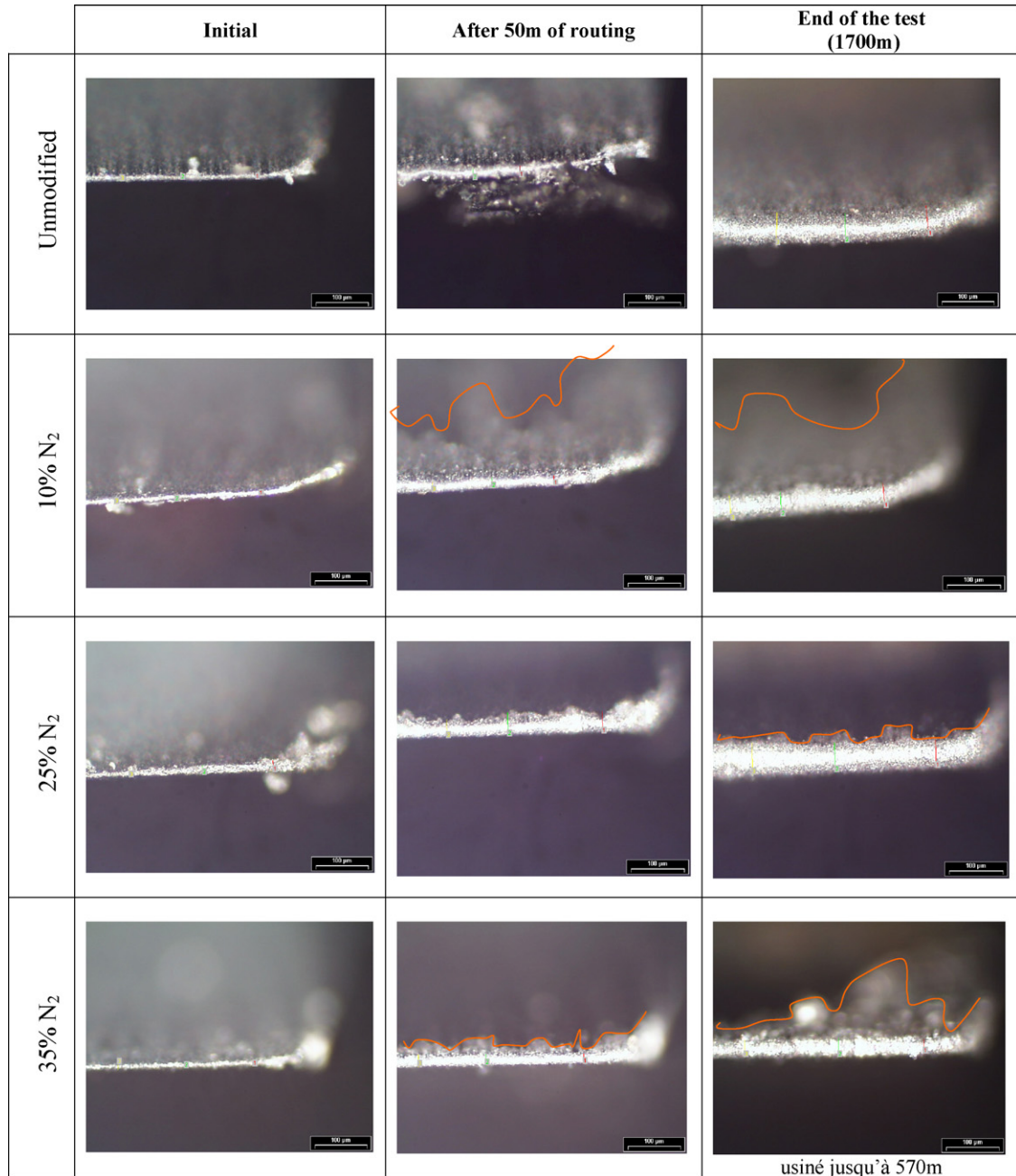

Fig. 12. Optical observations of the cutting edges during routing of MDF (magnification $\times 20$) with CrAlN-coated tools.

also see the importance of the lapping (first 150 m of machining): on the one hand, if a tool performed well during this period, it will have good results at the end of the test. On the other hand, like the first test with the carbide coated with 25% of N₂, the tool will not be efficient during the routing process. But as we can see on Fig. 11, the best tool is the one coated with 10% of N₂ which permitted to machine 2.5 times more than the unmodified tool, for equal wear.

The first edge of the tool coated with 25% of N₂ presented a bad surface state observed by SEM which can explain its bad performances.

Another parameter to be studied is the shape of the different curves: during the lapping period and after, the coated tools

always present lower shape than the unmodified one (except for the first edge of the tool coated with 25% of N₂).

Besides, we observed by optical microscopy the cutting edges to verify the adhesion of the coatings during the routing process (Fig. 12). We only observed the rake face because this face is the only one in contact with the veneer during the routing process which means that it is the more stressed during the wood machining. In Fig. 12 we note that the more adherent coating seems to be the one obtained with 25% of N₂ in the plasma. Besides, the one obtained with 10% of N₂ in the plasma is the less adherent while it is the most efficient in wear resistance. This probably means that after 1700 m of routing, this tool must lose its efficiency. These results could also be explained by the

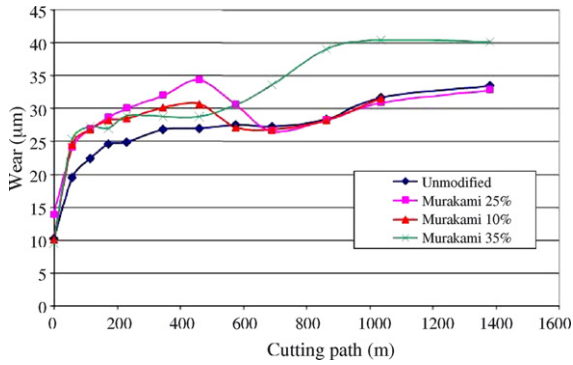

Fig. 13. Wear of the cutting edge vs. the cutting path in routing of MDF with Murakami's attacked and CrAlN-coated carbide tools.

highest hardness so a highest fragility of this coating which were verified in scratch-test (Fig. 10C).

As a conclusion, according to these results we should employ coatings with around 20% of nitrogen for routing instead of 10 or more than 25%.

3.3.2. Routing of MDF with Murakami's attacked and CrAlN-coated carbide inserts

Secondly, we tested CrAlN-coated tools previously attacked with Murakami's agent in routing of MDF. We also verified the influence of the nitrogen content while the other parameters were fixed. The results are shown in Fig. 13. As we can see they are not at all positive: during the lapping period or even after, the pre-treated tools behaved worse than the unmodified one. It seems

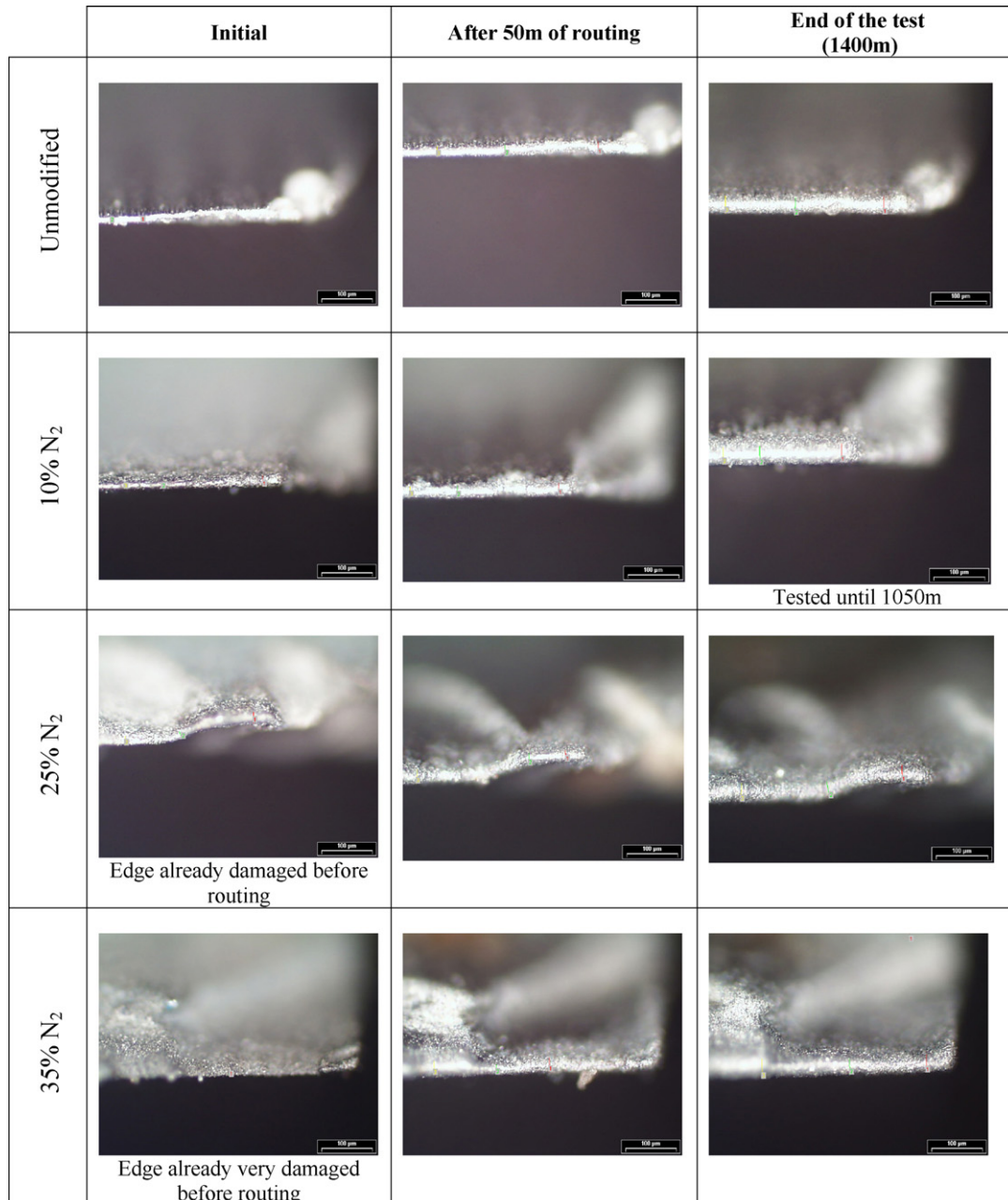

Fig. 14. Optical observations of the cutting edges during routing of MDF (magnification $\times 20$) with Murakami's attacked and CrAlN-coated tools.

clear that Murakami's attack weakened the carbides: maybe a 5 min attack was too long, which resulted in a too deep cobalt dissolution and to the removal of the WC grains at the tools surfaces? SEM observations showed before machining that the attack was especially concentrated near the cutting edge which could explain the fast degradation of the tools. After removal of the surface attacked of the cutting edges, the tools behaved like the unmodified one, as if they had not been treated at all. The degradation seems to be higher in the case of the tool coated with 35% of N₂ in the plasma which always behave worse than the other ones.

As we observe in Fig. 14, the fast wear of the pre-treated tools came from the WC grains removal: we see on all optical images that the coating is still present at the end of the test (dark zone) even on very damaged cutting edges.

4. Conclusions

During this study, we optimized the deposition conditions by RF magnetron sputtering of CrAlN coatings in view to apply them on carbide inserts for routing of MDF. The optimal physico-chemical and mechanical properties were obtained for a working pressure of 4 μbar, a target voltage of -900 V, a deposition time of 90 min (around 1.5 μm) and a nitrogen content in the plasma of around 20%.

In these conditions, we obtained coatings with hardness of around 20 GPa and adherent on carbide tools. The coatings are also low stressed and permit to machine up till 2.5 times more than unmodified ones after 1700 m of routing.

Nevertheless, Murakami's agent attack failed even if the coatings were efficient which means that this is perhaps not a solution to improve the adhesion of nitride coatings on carbide inserts. An optimization of the attack is necessary and is in progress.

Acknowledgements

We wish to thank the Regional Council of Burgundy for its financial support of the study. We also thank ISOROY France who provided us MDF panels for routing. Finally we wish to thank all colleagues (from Dijon, Angers, Besançon) who helped us for the characterizations of our layers.

References

- [1] M. Van Stappen, M. Kerkhofs, L.M. Stals, C. Quaeys, State of the art for the industrial use of ceramic PVD coatings, *Surf. Coat. Technol.* 74–75 (1995) 629–633.
- [2] C. Nouveau, M.-A. Djouadi, R. Marchal, M. Lambertin, Applications de revêtements durs (Cr_xN_y) obtenus par méthodes P.V.D. à l'usinage du bois: Applications of hard coatings (Cr_xN_y) obtained by P.V.D. methods in wood machining, *Méca. Indus.* 3 (2002) 333–342.
- [3] C. Labidi, R. Collet, C. Nouveau, P. Beer, S. Nicosia, M.-A. Djouadi, Surface treatments of tools used in industrial wood machining, *Surf. Coat. Technol.* 200 (1–4) (2005) 118–122.
- [4] T. Morita, J. Sheikh-Ahmad, K. Bانشويا, T. Tsutsumoto, Y. Murase, *Forest Products J.* 50 (1) (2000) 67–73.
- [5] C. Labidi, R. Collet, C. Nouveau, M.-A. Djouadi, S. Nicosia, P. Beer, Behaviour of modified canter and peeling knives in primary wood transformation, in: *Proceedings of the Second International Symposium on Wood Machining*, July 5–7, 2004, pp. 475–480.
- [6] C. Nouveau, Etude de revêtements durs (Cr_xN_y) obtenus par méthodes PVD: réalisation et caractérisations, applications à l'usinage du bois, Ph.D. (n°21-2001), CER ENSAM Cluny France.
- [7] C. Nouveau, M.-A. Djouadi, O. Banakh, R. Sanjinés, F. Lévy, Stress and structure profiles for chromium nitride coatings deposited by r.f. magnetron sputtering, *Thin Solid Films* 398–399 (2001) 490–495.
- [8] M.-A. Djouadi, C. Nouveau, O. Banakh, R. Sanjinés, F. Lévy, G. Nouet, Stress profiles and thermal stability of Cr_xN_y films deposited by magnetron sputtering, *Surf. Coat. Technol.* 151–152 (2002) 510–514.