



Science Arts & Métiers (SAM)

is an open access repository that collects the work of Arts et Métiers Institute of Technology researchers and makes it freely available over the web where possible.

This is an author-deposited version published in: <https://sam.ensam.eu>
Handle ID: <http://hdl.handle.net/10985/11408>

To cite this version :

Laurent CHOUGRANI, Stéphane ABED, Jean-Philippe PERNOT, Philippe VERON - Parts internal structure definition using lattice patterns optimization for mass reduction in additive manufacturing - In: Tools and Methods for Competitive Engineering (Aix-en-Provence : 16 : 2016), France, 2016 - Proceeding of Tools and Methods for Competitive Engineering - 2016

Any correspondence concerning this service should be sent to the repository

Administrator : scienceouverte@ensam.eu



PARTS INTERNAL STRUCTURE DEFINITION USING LATTICE PATTERNS OPTIMIZATION FOR MASS REDUCTION IN ADDITIVE MANUFACTURING

Laurent Chougrani^{1,2}

LSIS Laboratory

¹Arts & Métiers ParisTech LSIS laboratory UMR CNRS 7296

²Poly-Shape

France

l.chougrani@poly-shape.com

Philippe Véron

Jean-Philippe Pernot

LSIS Laboratory

¹Arts & Métiers ParisTech LSIS laboratory UMR CNRS 7296

{Philippe.Veron, Jean-Philippe.Pernot}@ensam.eu

Stéphane Abed

Poly-Shape

France

s.abed@poly-shape.com

ABSTRACT

With the rise of additive manufacturing, complex internal structure optimization is now a relevant topic. Additive manufacturing allows designers and engineers to go further in their modeling, designing and optimization process, allowing new complex shapes to be produced, including the optimization of their internal structure. However modeling, design and optimization tools still represent a limitation to that new horizon of printable shapes.

In this article, we define the framework in term of new designs, 3D modeling and optimization approach dedicated to the shape definition of patterned (or organized) lattice structures¹ produced using additive manufacturing processes. The goal being to generate shapes that fit the mechanical requirements with an “as reduced as possible” mass, this issue is still today a niche market for Aerospace and Automotive, but could soon lead to a wider range of applications. Optimizing topology can be slow, so we will show a way of reducing computation time by using relative criteria for removing material. This new approach is based on the use of organized lattice structures to allow a wide range of shapes, thus opening the field for finding better optimized shapes. Once the patterned lattice structure is defined, it is send to a Finite Element solver software that returns the constraints and/or displacements map. This is then used as a basis for a statistical calculus that determines the elements that can or cannot be removed from the lattice. After a few

iterations, the general structure is no longer patterned, but organized in a way that suits its mechanical environment, allowing lighter general structure and ensuring its rigidity. This approach is illustrated with examples coming from a prototype software.

KEYWORDS

Additive manufacturing, 3D modelling, Shape optimization, Lattice structures, Finite Element analysis, Mass reduction.

1. INTRODUCTION

Additive manufacturing is a quite new but yet wildly developing industry which changes radically the ways of design. Classic industrial processes like milling or machining tend to use physical tools to remove a volume, extracting the desired structure from it, whereas Additive manufacturing (especially Laser Beam Melting (LBM) and Electron Beam Melting (EBM)) tends to start from barely nothing: a metal powder, and build the desired structure out of it, using energy beams (immaterial tools) to locally fuse and solidify the material. [1].

Those new technologies present new productions constraints, limitations and moreover a totally different way of designing. Through additive manufacturing, new terminologies of design have raised, the notion of lattice structures is now commonly used.

Lattice structures are an interesting way for additive manufacturing to stand out from other means of

¹ Structures composed of several interconnected physical beams

productions. Those structures cannot be created through other technologies, they still have mechanical properties yet to be investigated and they offer a very promising way for mass reduction.

Any industrial actor that produces system that move (automotive, aerospace etc...), tend to reduce mass for energetic purposes. Additive manufacturing proposes nowadays two main ways to achieve that, one being the lattice insertion, the other involving topology optimization. (Figure 2).

Both technics lead to complex shapes that can be hard or impossible to manufacture. Integrating the manufacturing process constraints into the global optimization pattern is a crucial issue.

There already are examples of industrial success stories involving mass reduction through additive manufacturing (Figure 1). Costs for such parts being high, it is still a niche market, essentially for aerospace, automotive and energy fields. Integrating the process constraints into a part optimization method will lead to lowering prices, and open up the market.

Moreover, as the final geometry might be convoluted, the computation time for optimization can be very high (and the number of iteration can be high too). We will propose a method to decrease this

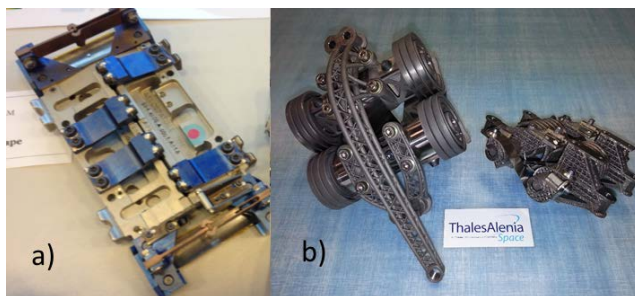

Figure 1 Solar panel opener project, courtesy of Thales Alenia Space & Poly-Shape. a) Non additive manufacturing design, b) additive manufacturing design: mass reduce 5 times, costs reduced 4 times, number of components reduced about 10 times. Used method: combination of Topology and lattice insertion.

time.

In this paper, we describe a way of conceiving and optimizing structures in order to reduce their mass while guaranteeing their rigidity through requirement specifications and their additive manufacturability. We will briefly introduce topology optimization and see how lattice insertion can also tackle mass reduction issues. Nowadays there are no software

that can really generate an optimized structure that fit both mass criterions and Additive Manufacturing

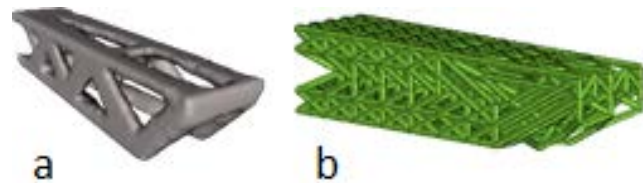

Figure 2 Topology optimization of a cantilever (a). Lattice optimization of the same cantilever (b)

constraints.

2. RELATED WORK

In order to define rigid, light and printable structures. We need to get an overview of the different methods and studies that have already been done on that subject.

2.1. Topology optimization

Continuous topology is a new way of modifying

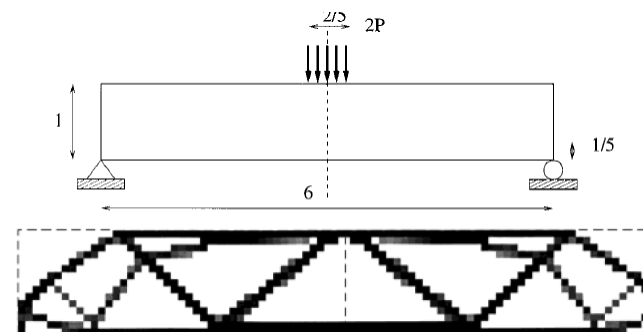

Figure 3 Beam Problem and its associated compliance design (45x15 finite elements)

structures in order to get light weight parts [2] :

We can see from those optimization designs that most of the resulting structures are made out of beams or plates. This observation combined with Additive manufacturing capacities has also lead to Lattice structures studies. [3]

Unfortunately Topology optimization can get time consuming when the required results needs to be of a high resolution (high number of voxels), and generally lead to noisy structures if the resolution is not high enough. (Figure 4)

Topology optimization on its own contains some limitations, like computation time, those limitations can be dealt with through seeing that topology results

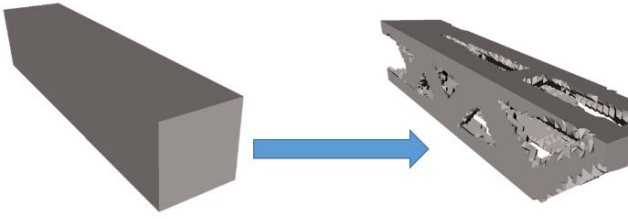

Figure 5 example of a noisy topology optimization result. Initial structure (left), noisy result (right)

could be interpreted as plates or beams interconnected structures (Figure 3).

2.2. Bio-mimicry

Nature is a source of inspiration, and we can see that the shapes that it generates, resemble topology optimization results.

In 2014 a researcher team manage to artificially compute a lizard skull through topology optimization [4]. Showing that seeking for shape ideas in nature can totally make sense (Figure 5).

This seek for nature comparison is called biomimicry and is getting more and more investigated. Some approach tend to search for patterns that could be used for lattice insertion (as topology gives geometries that resemble Lattice structures). Among them: Voronoï diagrams, Delaunay tessellation, fractals (Figure 6)

Those schemes can be useful because they can be easily generated and propagated through a volume. However they represent a difficulty in terms of mechanical models, this is why we will only discuss

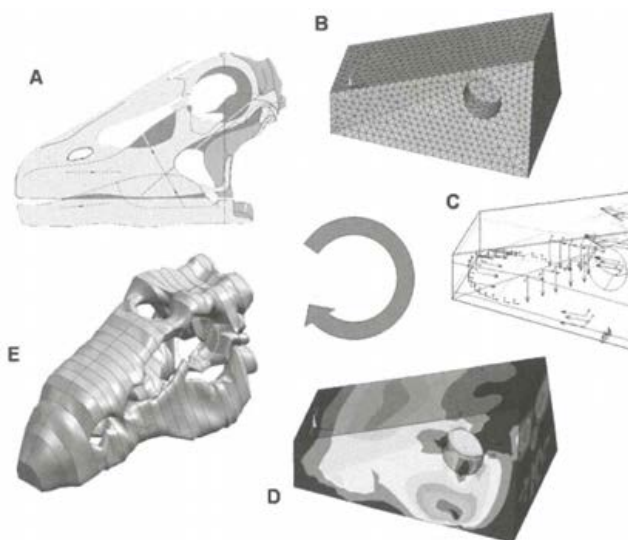

Figure 4 Topological approach for bio-mimetic simulation of a skeleton (Witzel and Preuschoft 2014)

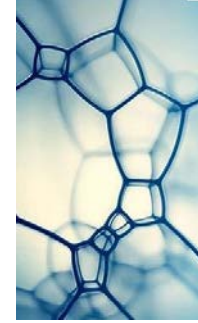
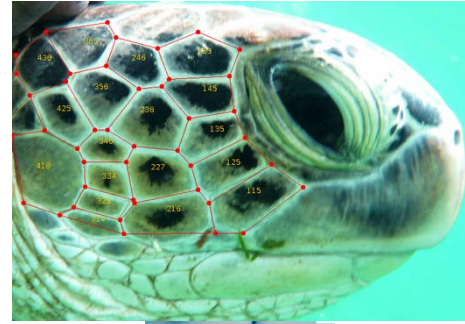

Figure 6 Examples of natural Voronoï diagrams

patterned lattice in this paper.

The design of patterned lattice are often referring to crystallographic structures (Figure 7). Replacing atoms with nodes, and inter-atomic links with beams. We will assume as a first hypothesis that this comparison is valid, and build a patterned lattice out of those considerations.

Patterned lattice structures presents a main problem, which is that once the pattern is chosen, the topology is fixed. Meaning that the solution will be driven by

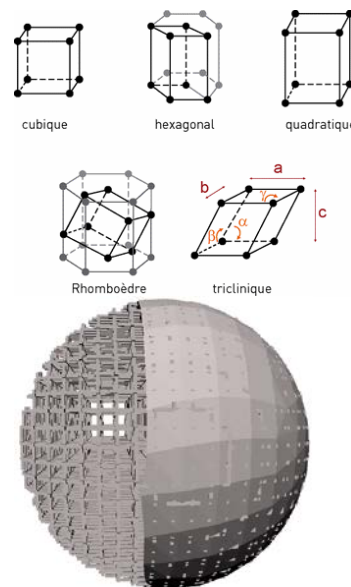

Figure 7 Examples of atomic lattice structures (left) [5], insertion of a crystallographic quadratic type lattice within a sphere (right).



Figure 8 Low stressed bone (a). Normally stressed bone (b) [6]

an arbitrary choice of the user, the choice of the pattern. We will tackle this issue through biomimicry.

Going further into our bio-mimetic comparison, nature's ultimate issue is energy. Thus, any living creature tends to minimize its energy consumption. Any organs or body parts needs to be fed with nutriments, oxygen and other components. So, considering that the amount of energy generated per amount of time is fixed for a creature, it needs to distribute this energy among all of its body parts. The way it does it can be describe like this, the percentage of energy distributed to a particular body part, is proportional to this body part contribution to the whole body capacity to sustain itself.

Even if we will focus on mechanical structures, the body parts that we will look after can be compared to bones of a skeleton (Figure 8), because their main purpose is to give rigidity to the creature's body (we will neglect all other purposes of bones to make it

simpler).

According to what we just said, we will define an optimization framework that looks for every beam (comparatively to bones in a skeleton), and sort the contribution of each beam to the structure's rigidity in order to decide if "it should be fed", meaning that it should stay, or "starve", meaning that the beam should be suppressed. (This is close to what topology optimization does but applied to lattice structures). This principle has been experimented on human bones by manipulating the amount of stress received by a bone and looking at the evolution of the bone shape and mass over time. [6]

This is based both on Darwin's theories of evolution [7] and bone structures observations. [8]

This shows that in term of density (that can be related to beams diameter), bones tend to reduce their thickness if they are not stressed.

We now have a way of modifying a lattice structure according to biomimicry. We will then propose a structure optimization framework that involves lattice structures modification in that way.

In this paper we will not modify diameters of beams, but consider that if the beam contribution is under a certain amount, this beam can be directly removed.

3. OPTIMIZATION FRAMEWORK

Additive manufacturing offers the possibility to produce complex shapes. Though, creating porous instead of fully dense structures become possible, and we can add material where it is mechanically needed instead of removing material where it is not

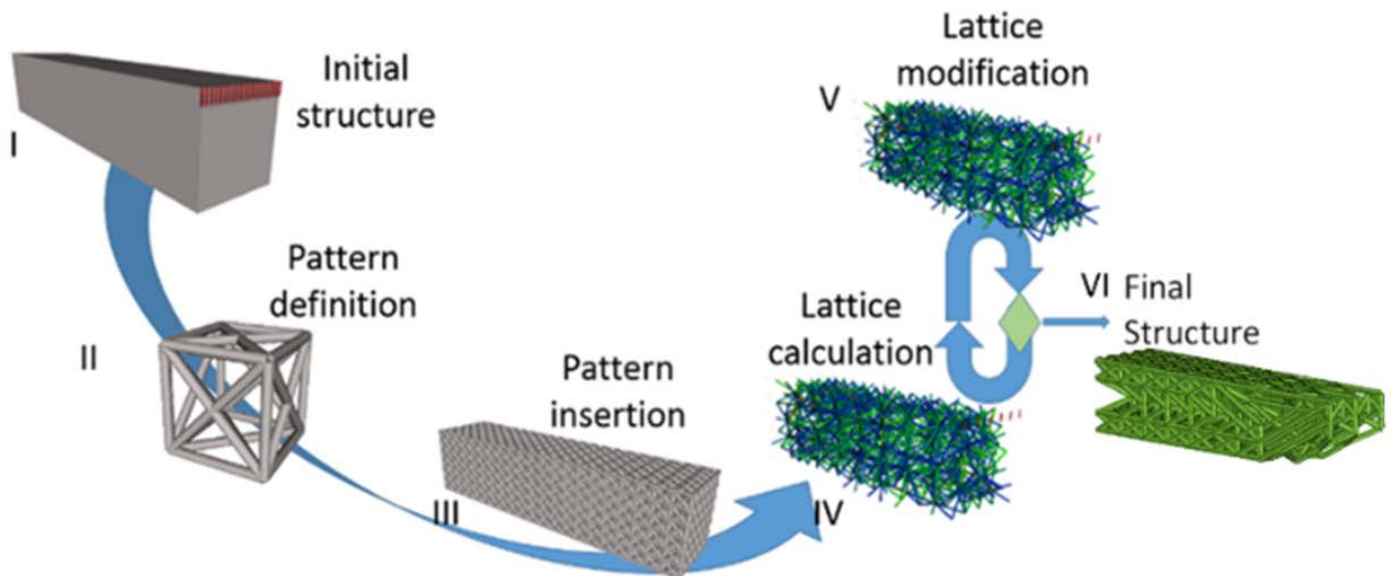

Figure 9 Framework for patterned lattice structures optimization

mechanically needed (machining).

We decide, in order to get faster computation, to implement an iterative algorithm to select if a beam should be kept or destroyed regarding its stress relative level.

Our method consist in different steps (Figure 9):

First we need to select a lattice pattern, based on its mechanical behaviour and its printability (Figure 9.II), we then propagate this pattern within our volume (Figure 9.III). A first calculation is performed in order to ensure that the limit criteria is not already reached (stress or displacement) (Figure 9.IV).

We finally run the optimization loop until this criteria is reached (Figure 9.V). This loop consists in supressing beams that contribute the less to the mechanical “stress absorption” (this will be discussed later on) of the structure, according to our biomimicry statements and a statistical evaluation of the considerate beam contribution among the whole beam population. This process stops when a certain limit is reach (here we’ll take a Von Mises constraint limit) (Figure 9.VI) and the structure is saved. In this paper we will choose a simple initial volume.

4. METHOD

4.1. Pattern definition

Considering that lattice can be created out of crystallographic structures, by replacing atoms by nodes and atom links by beams, we will compare several models in term of mechanical behaviour. To quickly illustrate the way we choose an initial pattern, we will expose the result of two extreme

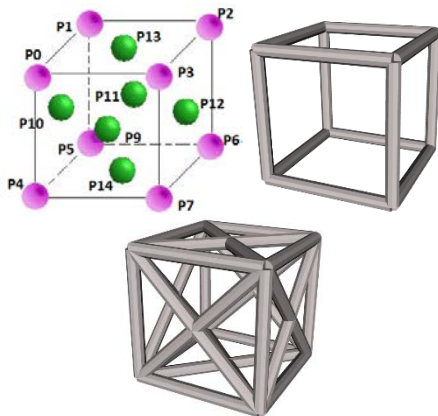

Figure 10 FCC crystallographic atoms. The Grid pattern only uses purple nodes (P0 to P7), and the FCC pattern uses both purple and green atoms (P0 to P14), (left). Grid pattern (middle), FCC pattern (right)

cases. A “Grid” pattern and a “FCC” pattern

Using the denomination in Figure 10, the Grid and FCC patterns can be define using an incidence matrix C (Graph theory) [9] :

Considering a set of vertex (P_0, \dots, P_n) and a set of beams (B_0, \dots, B_m) , C is a matrix of $n \times m$ dimension such as

$$m_{ij} \begin{cases} 1 & \text{if } B_i \text{ is connected to } P_j \\ 0 & \text{otherwise} \end{cases}$$

(Graph theory also allows for -1 value, but we won’t need it in our case)

Using this notation we get:

$$C_{grid} = \begin{pmatrix} 1 & 1 & 0 & 0 & 0 & 0 & 0 & 0 & 0 & 0 & 0 & 0 & 0 & 0 & 0 & 0 \\ 1 & 0 & 0 & 1 & 0 & 0 & 0 & 0 & 0 & 0 & 0 & 0 & 0 & 0 & 0 & 0 \\ 1 & 0 & 0 & 0 & 1 & 0 & 0 & 0 & 0 & 0 & 0 & 0 & 0 & 0 & 0 & 0 \\ 0 & 1 & 1 & 0 & 0 & 0 & 0 & 0 & 0 & 0 & 0 & 0 & 0 & 0 & 0 & 0 \\ 0 & 1 & 0 & 0 & 0 & 1 & 0 & 0 & 0 & 0 & 0 & 0 & 0 & 0 & 0 & 0 \\ 0 & 0 & 1 & 1 & 0 & 0 & 0 & 0 & 0 & 0 & 0 & 0 & 0 & 0 & 0 & 0 \\ 0 & 0 & 1 & 0 & 0 & 0 & 1 & 0 & 0 & 0 & 0 & 0 & 0 & 0 & 0 & 0 \\ 0 & 0 & 0 & 1 & 0 & 0 & 0 & 1 & 0 & 0 & 0 & 0 & 0 & 0 & 0 & 0 \\ 0 & 0 & 0 & 0 & 1 & 1 & 0 & 0 & 0 & 0 & 0 & 0 & 0 & 0 & 0 & 0 \\ 0 & 0 & 0 & 0 & 0 & 1 & 0 & 0 & 0 & 0 & 0 & 0 & 0 & 0 & 0 & 0 \\ 0 & 0 & 0 & 0 & 0 & 0 & 1 & 1 & 0 & 0 & 0 & 0 & 0 & 0 & 0 & 0 \end{pmatrix}$$

$$C_{fcc} = \begin{pmatrix} 1 & 1 & 0 & 0 & 0 & 0 & 0 & 0 & 0 & 0 & 0 & 0 & 0 & 0 & 0 & 0 \\ 1 & 0 & 0 & 1 & 0 & 0 & 0 & 0 & 0 & 0 & 0 & 0 & 0 & 0 & 0 & 0 \\ 1 & 0 & 0 & 0 & 1 & 0 & 0 & 0 & 0 & 0 & 0 & 0 & 0 & 0 & 0 & 0 \\ 1 & 0 & 0 & 0 & 0 & 0 & 0 & 0 & 0 & 1 & 0 & 0 & 0 & 0 & 0 & 0 \\ 1 & 0 & 0 & 0 & 0 & 0 & 0 & 0 & 0 & 0 & 1 & 0 & 0 & 0 & 0 & 0 \\ 1 & 0 & 0 & 0 & 0 & 0 & 0 & 0 & 0 & 0 & 0 & 0 & 1 & 0 & 0 & 0 \\ 0 & 1 & 1 & 0 & 0 & 0 & 0 & 0 & 0 & 0 & 0 & 0 & 0 & 0 & 0 & 0 \\ 0 & 1 & 0 & 0 & 0 & 1 & 0 & 0 & 0 & 0 & 0 & 0 & 0 & 0 & 0 & 0 \\ 0 & 1 & 0 & 0 & 0 & 0 & 0 & 0 & 0 & 0 & 1 & 0 & 0 & 0 & 0 & 0 \\ 0 & 1 & 0 & 0 & 0 & 0 & 0 & 0 & 0 & 0 & 0 & 1 & 0 & 0 & 0 & 0 \\ 0 & 0 & 1 & 1 & 0 & 0 & 0 & 0 & 0 & 0 & 0 & 0 & 0 & 0 & 0 & 0 \\ 0 & 0 & 1 & 0 & 0 & 0 & 0 & 0 & 0 & 0 & 1 & 0 & 0 & 0 & 0 & 0 \\ 0 & 0 & 1 & 0 & 0 & 0 & 0 & 0 & 0 & 0 & 0 & 1 & 0 & 0 & 0 & 0 \\ 0 & 0 & 0 & 1 & 0 & 0 & 0 & 1 & 0 & 0 & 0 & 0 & 0 & 0 & 0 & 0 \\ 0 & 0 & 0 & 1 & 0 & 0 & 0 & 0 & 0 & 1 & 0 & 0 & 0 & 0 & 0 & 0 \\ 0 & 0 & 0 & 0 & 1 & 0 & 0 & 0 & 0 & 0 & 0 & 1 & 0 & 0 & 0 & 0 \\ 0 & 0 & 0 & 0 & 1 & 0 & 0 & 0 & 0 & 0 & 0 & 0 & 1 & 0 & 0 & 0 \\ 0 & 0 & 0 & 0 & 1 & 0 & 0 & 0 & 0 & 0 & 0 & 0 & 0 & 1 & 0 & 0 \\ 0 & 0 & 0 & 0 & 1 & 0 & 0 & 0 & 0 & 0 & 0 & 0 & 0 & 0 & 1 & 0 \\ 0 & 0 & 0 & 0 & 1 & 0 & 0 & 0 & 0 & 0 & 0 & 0 & 0 & 0 & 0 & 1 \\ 0 & 0 & 0 & 0 & 0 & 1 & 1 & 0 & 0 & 0 & 0 & 0 & 0 & 0 & 0 & 0 \\ 0 & 0 & 0 & 0 & 0 & 0 & 1 & 0 & 0 & 0 & 0 & 1 & 0 & 0 & 0 & 0 \\ 0 & 0 & 0 & 0 & 0 & 0 & 1 & 0 & 0 & 0 & 0 & 0 & 1 & 0 & 0 & 0 \\ 0 & 0 & 0 & 0 & 0 & 0 & 1 & 0 & 0 & 0 & 0 & 0 & 0 & 1 & 0 & 0 \\ 0 & 0 & 0 & 0 & 0 & 0 & 1 & 0 & 0 & 0 & 0 & 0 & 0 & 0 & 1 & 0 \\ 0 & 0 & 0 & 0 & 0 & 0 & 0 & 1 & 0 & 0 & 1 & 0 & 0 & 0 & 0 & 0 \\ 0 & 0 & 0 & 0 & 0 & 0 & 0 & 1 & 0 & 0 & 0 & 1 & 0 & 0 & 0 & 0 \\ 0 & 0 & 0 & 0 & 0 & 0 & 0 & 0 & 1 & 0 & 0 & 0 & 0 & 0 & 0 & 1 \end{pmatrix}$$

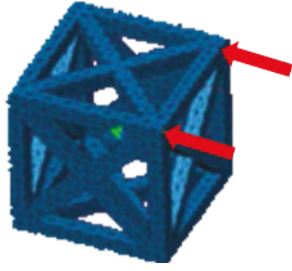

Figure 11 Deformation of the FCC Patterned lattice structure under the same pure shear load case (scale factor for deformation: 10)

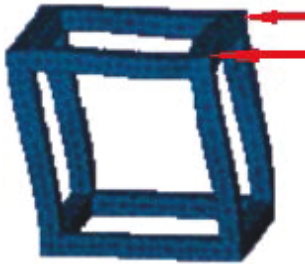

Figure 12 Deformation of the Grid Patterned lattice structure under pure shear load case (scale factor for deformation: 10)

This matrix is all we need to define the whole structure by looping through the volume.

The pattern choice will indeed impact the geometry, but also the mechanical behaviour. To illustrate this, we will show this two patterns loaded with pure shear stress. (Figure 11 & Figure 12). Results are displayed in Table 1.

Table 1 Comparison between the two Patterned lattices in terms of volume and displacement

	Grid	FCC	FCC/Grid ratio
max displacement (mm)	4,98E-03	5,26E-04	1056%
max V.M. (MPa)	27,8	5,01	1802%
Volume (mm ³)	1,04E-07	2,28E-07	219%

We can see that the FCC offers a great diminution (ten times less) in term of displacement for only two times more mass.

Starting with a FCC-based lattice structure is not an issue since our optimization process is supposed to remove beams. It is in fact a security, ensuring that we have a great variety of orientation and a high possibility of combinations.

Some research has been made for using different cells at different places within the structure according to mechanical criteria [10] (this method having its own problems like cell inter-connectivity). This can be an interesting way of improving calculation times, we choose here to use a FCC pattern as, by removing beams, we can get back to the Grid pattern.

4.2. pattern insertion

Once we decided which pattern will be used to fill the volume, we need to actually fill it.

In the case described, this is no complex matter, the beam is a parallelepiped volume and the patterned lattice fits into a cube. We only need to define a size for the cube which allows it to fill entirely the beam.

We then define a loop based on (x, y, z) unit cell dimensions, and (X, Y, Z) total beam dimension. In order to make it more user friendly, we can define a number of cells per axis Ni and then calculate the unit cell dimensions such as:

$$\begin{cases} x = \frac{X}{N_x} \\ y = \frac{Y}{N_y} \\ z = \frac{Z}{N_z} \end{cases} \quad (1)$$

And while looping through cells, we generate the beams (Figure 13). We also need to check for redundant Beams at run time, this is no matter as we

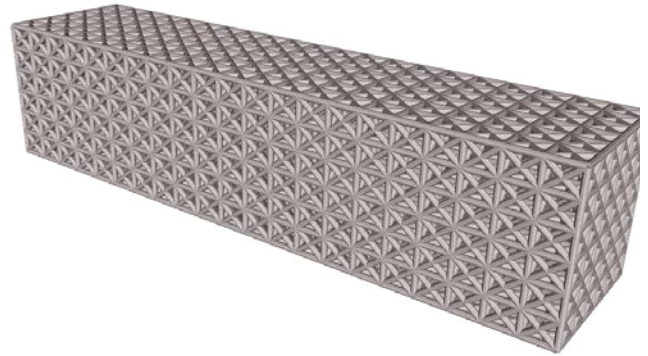

Figure 13 Isometric view of the initial beam filled with FCC-based lattice

know the connectivity matrix of the pattern.

4.3. Optimization loop

This study will only focus on reducing the mass relatively to a mechanical criteria (in this case Von Mises constraints). We will address this problem only by allowing beam deletion in a patterned lattice structure.

This beam deletion will be done on a relative statistic criteria, and will then impact the global volume (or mass) of the structure via this formula:

$$f(n) = \sum_{i=0}^n \pi \cdot r^2 \cdot L_i$$

Where “n” is the number of beam in the structure, “r” is the fixed radius of every beam and L is the length of each beam defined by the chosen pattern. (You can remark that we calculate each beam as a cylinder, not taking into account the little overlap on the connecting nodes between two or more beams)

So the only differentiation that can be made between two beams, rely on L, and is directly depending on the pattern that we chose. No economic or production time issue will be integrated in our method here.

Lattice calculation

Once the structure is generated, we need to define a

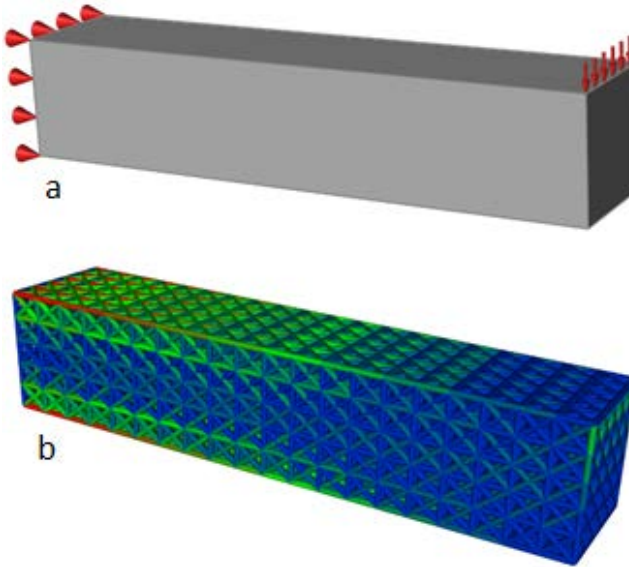

Figure 14 Illustration of the load case (a). Von Mises stress repartition of the FCC based lattice structure under that load case (red = highly stressed, blue: poorly stressed) (b)

load case. For that study, we consider, pure flexion.

We then send the lattice structure with its load case to a Finite Element solver that returns the averaged constraints (and/or displacements) in each beam. The beams are calculated as 1D structures in order to reduce computation times, the fact that we use 1D models brings up some errors that won't be discussed in this paper.

We now have a map of our structure giving us the constraints repartition, thus the contribution of each beams to the stress absorption.

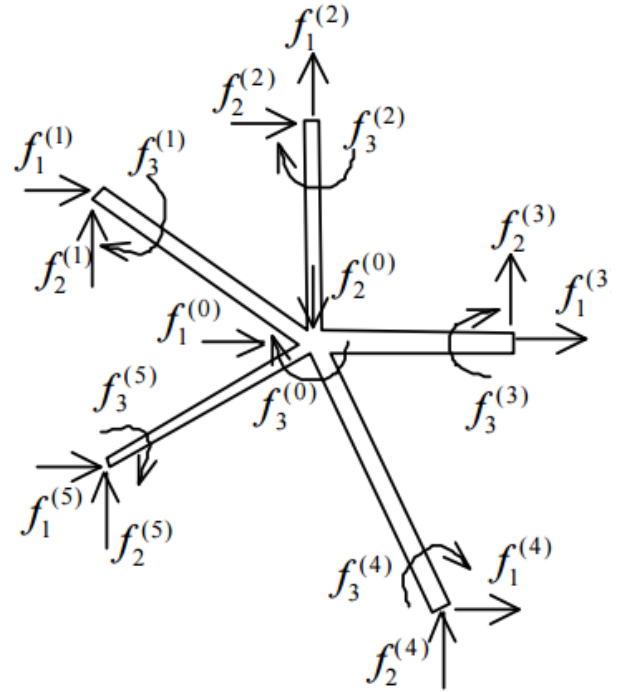

Figure 15 An example of a Vertex and the associated Effort variables (in 2D) [3], it can also be seen as a node neighbourhood

Beam deletion

We will now see how the structure behaves when we suppress a beam. To explain that, we can look at the structure in term of inter-connected unit cells. This concept can adapt to any type of pattern, so we will consider a random beam neighbourhood to remain general. (It will only depend on the connectivity matrix C):

Using energy conservation principle we can go back to a simplified approximation of the virtual work principle (using the fact that we are under the hypothesis of linear static mechanics and that the beams have the same radii)

We can then write that our isolated system is such as (Figure 15):

$$\begin{cases} \sum_{i=0}^5 f_1^{(i)} = 0 \\ \sum_{i=0}^5 f_2^{(i)} = 0 \\ \sum_{i=0}^5 f_3^{(i)} = 0 \end{cases} \quad (2)$$

Equation (2) leads to the fact that every time a beam will be removed, the stress repartition will be re-organized within the cells (of the whole structure). The way the re-organization work depends on the lattice pattern and on the load case.

We have made the hypothesis that we would only remove low stressed beam, so the amount of stress that was circulating within the suppressed beam needs to be redirected into other beams. This leading to the stress level of the surrounding beams rising.

If we call $f_{j_{suppressed}}^i$ the stress that was circulating through the suppressed beam and f' the new stress circulating through the surrounding beams, then we can say that:

$$\begin{cases} \sum_{j=1}^k \sum_{i=0}^n f'^{(i)}_j = 0 \\ \text{With } f'^{(i)}_j = f^{(i)}_j + f^i_{j_{suppressed}} \cdot \varepsilon(i) \end{cases} \quad (3)$$

In that situation, we consider a general case where the number of beam within the structure is “n”, we also generalize on the dimension we’re working on as “k” value can be fixed (in our example k=3). $\varepsilon(i)$ can be discussed regarding the selected pattern (the different incoming angles, radius of each beams, and the applied load case. Here we will simplify by using the same radius for each beam, a pattern that have only few different incidence angles.) But it will be chosen such as:

$$\begin{cases} \sum_{i=0}^n \varepsilon(i) = 1 \\ -1 \leq \varepsilon(i) \leq 1 \end{cases} \quad (4)$$

So that $\varepsilon(i)$ represents the percentage of stress that each remaining beam will have to sustain.

This phenomenon leads to stress homogenization within the structure.

4.3.3 Optimization criterion

Knowing the stress repartition in our part, we can remove the lattice elements that are unnecessary for the structure rigidity.

We first define a simple criterion of suppressing only one beam at a time, the less stressed beam of the whole structure. This criterion works but is way too slow for industrial applications with a high number of lattice elements.

Ideally, we could use a criteria that mimic those used in topology optimization (based either on level set method or homogenization of the compliance matrix), but the fact that we use 1D model create some difficulties in term of Finite Element methods. [11]

We decide to define a statistical method to sort out under-stressed beams. This criteria must be effective in term of optimization times and lead to a non-degenerated structure (degenerated meaning that the structure would not sustain the load case, as below. (Figure 16).).

Those degenerated structure comes from the fact that too many beams have been suppressed at the same time, and depends on the beam filter sensitivity. It is also due to the fact that Von Mises stresses repartition is not necessarily continuous within the structure, though by removing too many beams,

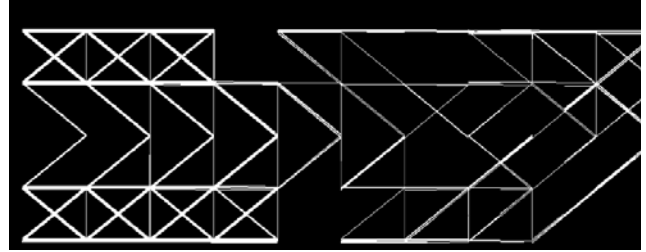

Figure 16 Side view of a degenerated structure, lines represents lattice elements

discontinuities can appear. (Figure 16).

The criterion we decide to use is based on mean stress in the structure and stress standard deviation. Using a statistical approach leads to a non-absolute criterion, each beam gets a notation relatively to the other lattice elements and to the maximum stress required. Meaning that even if our 1D model stress values are wrong if compared to the experience, it is still accurate in term of relative stress repartition, and we use that fact to select which beams need to be removed. 1D models are far faster to compute than 3D models, through this method we can compute dense lattice structures quickly and as the criterion is relative, we only need to calibrate a safety coefficient based on expert knowledge to stop the optimization process (and then use 3D finite elements analysis to get more precise values).

As a criterion we choose to look for (mean constraints – standard deviation). This criterion gives us both the position of the beam within the whole population (through standard deviation) and its distance to mean stress. For an homogeneous population of beams, this lead to a removal of less than 10% of the total population at each iteration [12], also leading to the fact that the number of beam that will be remove is proportional to the total number of beam remaining within the structure. This allows to auto-regulate the beam population and to converge to a non-removing beam situation.

This process is based on Topological optimization method [11], except that it does not uses compliance matrix to sort out the elements to suppress, but directly uses the Von Mises (approximated Von Mises due to 1D models) distribution.

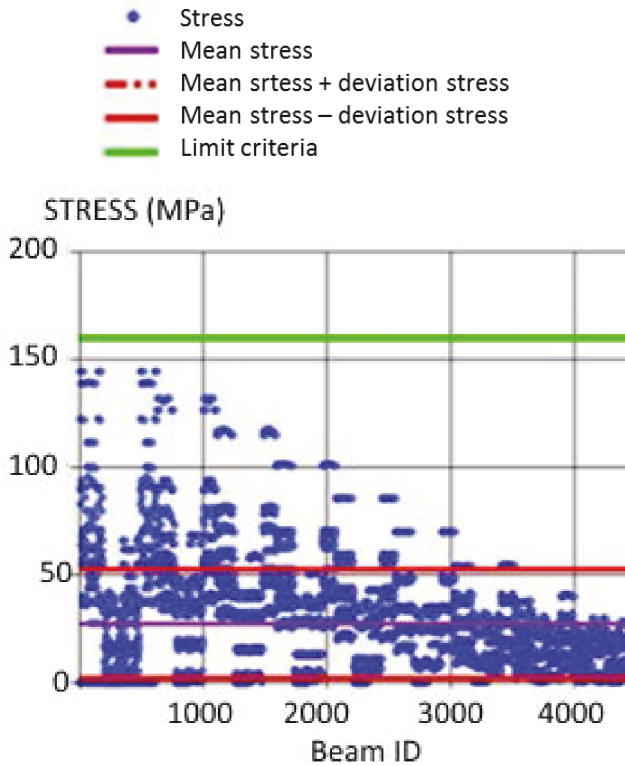

Figure 17 Stress repartition for the initial lattice structure. Mean constraint (violet line), mean constraint +standard deviation & mean constraint - standard deviation (red lines), maximum stress criterion (green line)

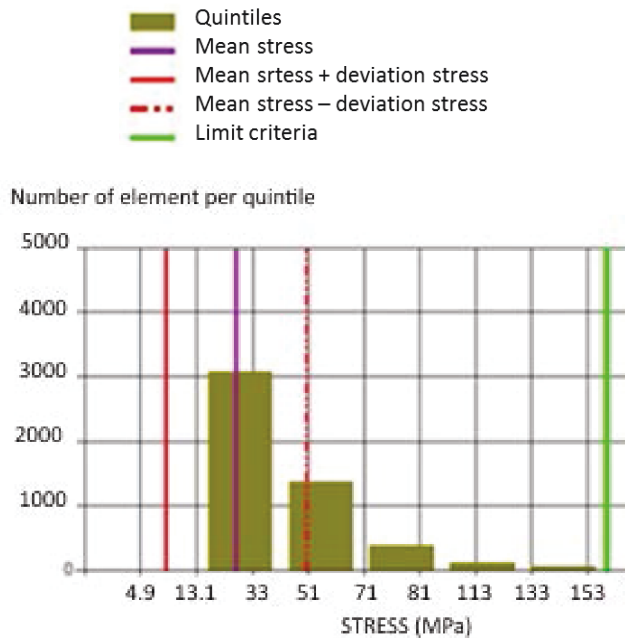

Figure 18 First iteration stress repartition per quintile within the structure. Mean constraint (violet line), mean constraint + standard deviation & mean constraint - standard deviation (red line), maximum stress criterion (green line)

As a start, this would consist in removing beams that

have a lower stress than (mean constraints – standard deviation), at each iteration. Suppressing beams is equivalent to changing the connectivity matrix C , and so equivalent to modifying the local pattern of the lattice. Meaning that, even starting with a pattern allows to change the topology of the whole lattice structure by changing locally the connectivity matrix. On first iteration we obtain the graphs shown in Figure 17&18.

Structure cleaning

The last iteration is not based on the statistical criteria, it is only made to remove self-hanging beam that technically would sustain no stress, so we only remove beam that have a stress level of 0 MPa ($\pm\epsilon$).

In order to be printed, parts need to be “cleaned” when exported into a .stl format. This step require for the lattice not to “self-overlap” (the beam intersection must be clean). That will not be discussed here, but needs to be taken into account in the optimization process.

5. IMPLEMENTATION AND RESULTS

In this work we will use Cast3m as a Finite Element solver for our calculations. Our solution a prototype software, based on DirectX technology, that communicate with Cast3m, sending data to be calculated and getting the results back. (Figure 19)

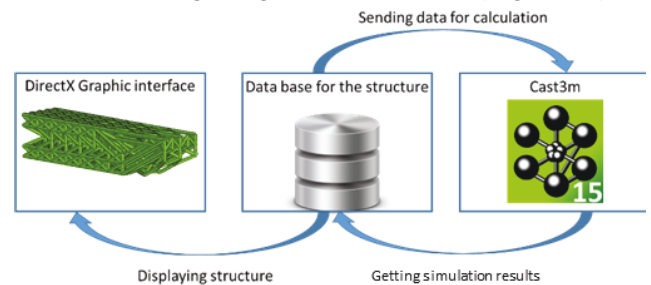

Figure 19 Schematic representation of the data transfer during calculation

As a result for this example, we obtained a structure after a few iterations (about 10), which suits the technical requirements we fixed and allows an effective mass reduction (Table 1). The initial maximum stress for the fully dense beam (filled with FCC patterned lattice) is 144MPa, we authorize our optimization solution to go up to 170MPa (18.05% increase in stress maximum value) (Table 1).

The final structure is not degenerated and allows stress homogenization within the structure.

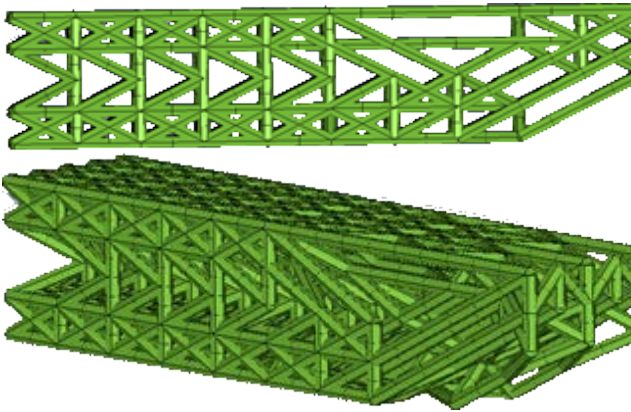

Figure 20 Side and isometric view of the final structure

Looking at Figure 20, we can see that the denser parts of our structure is located on the upper and lower plans near the fixations, and that material on the centre can be remove, which is related to what usual optimization concepts lead to.(Figure 21).



Figure 21 Classical optimized shape for a cantilever

Figure 22 and Figure 23 show that the stress repartition is better than for the initial lattice structure (Figure 16 and Figure 17). It also shows that the maximum stress criteria (green line) is still away

Table 2 Comparison of the maximum stress and associated volume for the initial and final structure

	Initial lattice structure	Final lattice structure	Gain (%)
volume (cm ³)	97	37,7	-61.14
maximum stress (MPa)	144	170	+18.05
Number of beams	4000	2200	-45

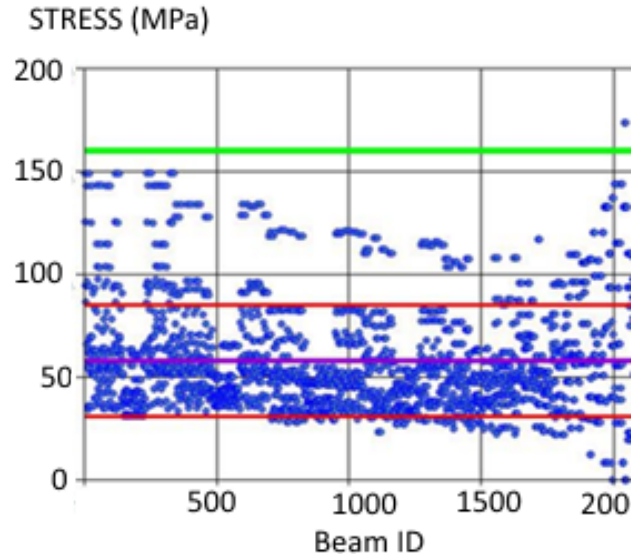

Figure 22 Final iteration stress repartition within the lattice optimized structure

from most of the lattice element. We can see that one element is over that criteria, this is due to the fact that we only removed beams, if we had used other functions, like radius modification, this could have been avoid. Radius changing will be address in another paper. This structure is way lighter than the initial one but could still be improved.

The fact that only one element is over maximum authorized stress, is certainly due to the pattern itself.

If we take a closer look at the stress repartition we can see that the general stress has gathered around the mean stress value, but we would have needed for the mean stress value to go as close as possible from

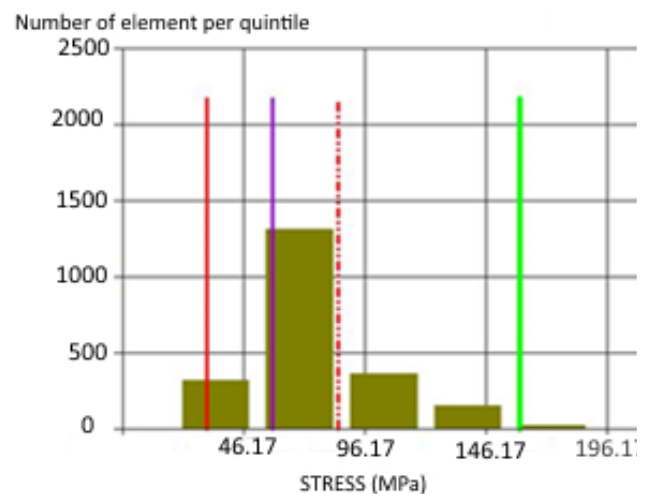

Figure 23 Last iteration stress repartition per quintile within the structure. Mean constraint (violet line), mean constraint + standard deviation & mean constraint - standard deviation (red line), maximum stress criterion (green line)

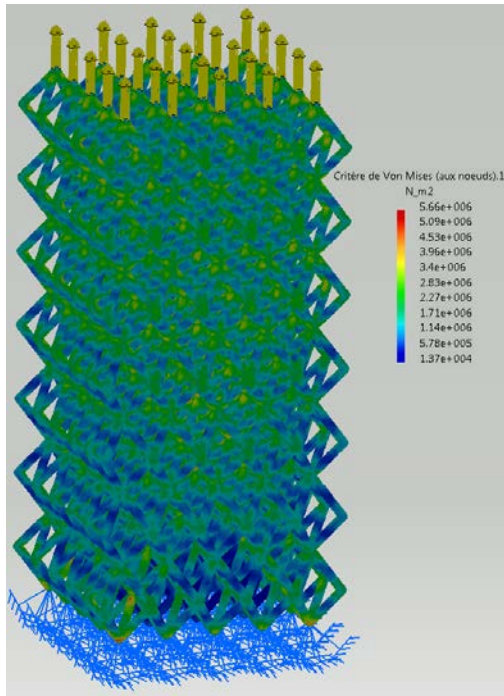

Figure 24 3D finite elements analysis of a patterned lattice structure.

the maximum admissible stress.

Figure 23 shows the quintile repartition of stress. (Be aware that the stress scale is not the same on the two graphics). It represents the migration of the stress population towards maximum admissible stress value, as well as the homogenization phenomenon.

As a comparison, we run a 3D finite elements simulation of a lattice structure (containing less beams than the one tested in this paper), the computation time was around 2 hours for meshing, 2 hours for calculating stress instead of few seconds with 1D models. Optimizing the cantilever above, took around 10 iterations which would lead to prohibitive computation time for industrial purposes. Our method allows to reduce the number of beam (using relative stress) in order to get a structure that can be then validated through 3D finite elements analysis (reducing the number of beam of 45% like we did, will imply much faster computation).

6. CONCLUSION AND FUTURE WORK

This paper shows another way of using lattice structures, starting from a pattern and making it evolve regarding stress repartition within the whole structure. Finally reaching an un-patterned lattice structure with a better repartition of the material. Using 1D finite elements does not allow us to go up to a total optimization, but to get a lattice shape containing as less beams as possible and then run a

3D finite elements calculation to ensure that the technical requirement are met. Finite elements models of lattice structures can surely be improve.

Our algorithm can only suppress beams. We are looking forward to also create beams where needed, modify the radii and move the beam nodes around. This would also mean that we need to take the Additive Manufacturing requirement into account during the process (and not only for pattern definition).

Finally, we also plan to change the statistical criteria into a gradient like algorithm that could regulate more parameters than just stress repartition.

REFERENCES

- [1] A. Gebhardt, *Understanding Additive Manufacturing*. Hanser, 2011.
- [2] P. Duysinx and M. P. Bendsøe, "Topology optimization of continuum structures with local stress constraints," *Int. J. Numeric Methods ENG*, vol. 43, pp. 1453–1478, Dec-1998.
- [3] V. W. Hongqing, "A unit cell approach for lightweight structure and compliant mechanism," Georgia Institute of Technology, 2005.
- [4] Witzel and Preuschoft, "International design conference, Dubrovnik, Croatia," May 2014.
- [5] J.-J. Rousseau and A. Gibaud, *Cristallographie géométrique et radiocristallographie*, 3rd ed. Dunod, 2007.
- [6] J. A. Howell, "An experimental study of the effect of stress and strain on bone development," vol. Volume 13, 2005.
- [7] C. Darwin, *The origin of species by mean of natural selection*. 1859.
- [8] J. Wolff, *The Law of Bone Remodeling*, Translation of the German 1892 edition. Germany: Springer, 1986.
- [9] J. A. Bondy and U. S. R. Murty, *Graph Theory with Applications*, 2nd Edition. North Holland, 1976.
- [10] D. M. Watts and R. J. Hague, "EXPLOITING THE DESIGN FREEDOM OF RM," 2006.
- [11] G. Allaire, *Conception optimale de structures*, 58 vols. Springer-Verlag Berlin Heidelberg, 2006.
- [12] E. J. Gumbel, *Les valeurs extrêmes des distributions statistiques*, Numdam., vol. 5. 1935.

