



Science Arts & Métiers (SAM)

is an open access repository that collects the work of Arts et Métiers Institute of Technology researchers and makes it freely available over the web where possible.

This is an author-deposited version published in: <https://sam.ensam.eu>
Handle ID: <http://hdl.handle.net/10985/22198>

To cite this version :

Abdul Salam KHAN, Ali SIADAT, Jean-Yves DANTAN, Lazhar HOMRI - Modularity-based quality assessment of a disruptive reconfigurable manufacturing system-A hybrid meta-heuristic approach - The International Journal of Advanced Manufacturing Technology - Vol. 115, p.1421-1444 - 2021

Any correspondence concerning this service should be sent to the repository

Administrator : scienceouverte@ensam.eu



Modularity-based quality assessment of a disruptive reconfigurable manufacturing system-A hybrid meta-heuristic approach

Abdul Salam Khan^{1,2} · Lazhar Homri¹ · Jean Yves Dantan¹ · Ali Siadat¹

Abstract

This study considers quality aspects in the process planning of a reconfigurable manufacturing system. The goal is to analyze how the variation in quality impacts the process planning, i.e., cost-based design and modular features. Besides this, the analysis helps in identifying the number of conforming and failed products delivered by a process plan. First, a multi-objective mixed integer non-linear programming model is proposed that contains the novel objectives of cost, quality decay, and modular efforts. Secondly, the model is implemented on an industrial case study by using an exact solution approach and a novel hybrid version of two popular meta-heuristics, namely non-sorting genetic algorithm and multi-objective particle swarm optimization. The hybrid heuristic helps strengthening the application of approaches by creating a balance in searching the solution space. The performance of different approaches is assessed by using two metrics and two termination criteria. The findings will help the decision-makers in assessing how quality-related issues impact the choice of a process plan and in understanding the trade-off among cost, quality, and modularity. Finally, conclusion and future research avenues are provided.

Keywords Reconfigurable manufacturing system · Reconfigurable process plan · Cost · Quality assessment · Variation · Multi-objective optimization · Hybrid heuristics

1 Introduction

Reconfigurable manufacturing system (RMS) is an advanced field of research which has been designed at its outset according to product needs [1]. It offers the advantages of high throughput and product variety. An important problem addressed in the field of RMS is process planning which assigns reconfigurable machines to different operations. While doing so, process plan assesses production capabilities and performs the assignment by optimizing the objective functions. The existing RMS literature uses cost, time, responsiveness, etc., as a criterion to analyze the performance of a process plan; however, among other aspects, the analysis of variation in quality is missing in the concerned literature. It is an important

aspect of a manufacturing system as variation increases cost and downplays the quality [2, 3]. A system becomes complex when there are a greater number of ways to connect machines in its production system. RMS is a complex manufacturing system as it uses gantries and conveyers to connect different machines which enhance the number of possibilities to link these machines. Thus, it becomes harder to analyze the quality of production in such complex manufacturing system.

The ability of RMS to offer multiple possible connections of machines (also called production routes) results in two quality-related problems [4]. Firstly, the variation in product dimensional quality increases as the product passes through different configurations. Secondly, if there is a problematic machine, it is hard to identify and trace it merely by inspecting the quality of product. In other words, thanks to the enhanced capabilities of RMS, a product may pass through one of the several designated routes. For 20 RMS production stages, each containing 6 machines, there are as much as 3.6×10^{15} ways to connect these machines [5]. It means that the product may pass through any of the 3.6×10^{15} production routes. This makes it complicated, even impossible, to analyze the product quality in each route. In addition, every aspect of a product cannot be analyzed by the manufacturing system.

✉ Abdul Salam Khan
abdul_salam.khan@ensam.eu; abdul.islam@nbs.nust.edu.pk

¹ Arts et Métiers Institute of Technology, Université de Lorraine, LCFC, HESAM Université, F-57070 Metz, France

² Department of Operations and Supply Chain, NUST Business School, National University of Sciences and Technology (NUST), Islamabad, Pakistan

Thus, a system only considers certain aspects of a product called key characteristics (KCs). KC accounts for most part of the quality variation and disruption of a product. In other words, the overall quality of a product can be improved by enhancing the quality of its key characteristics [6]. The dimensions, precision, and tolerances are some of the examples related to KC.

This study examines the impact of variation in quality on the performance of RMS process planning. The variation in quality of KC is studied by considering the assignable causes of process elements (PE). The machining, tooling, etc. can be regarded as the PE of a manufacturing system. An integrated approach is adopted to analyze cost, quality, and modularity effort. The analysis is performed by integrating the modularity characteristic of RMS. We consider modularity as an integral aspect of the RMS design. RMS uses a modular library which contains basic and auxiliary modules. The auxiliary modules are changeable, and thus they assist the RMS to change between configurations as per the requirement of different operations. Shaik et al. [7] suggested to include modularity during the design phase as it influences the overall flexibility and quality. The aim is to analyze not only the impact of quality variation on the performance of RMS but also how does the modularity of overall system get affected. An index is defined for modularity which considers the wasted modular effort during reconfiguration and in the presence of quality variations.

The proposed index of quality quantifies the number of conforming and failed units produced by a process plan. It highlights the variation in quality by using two models. Model 1 performs the analysis by using all three objective functions, i.e., the total cost (TC), the quality decay index (QDI), and the modularity effort (ME). Model 2 performs the analysis without using the index of quality. For implementing the model, we combine the non-sorting genetic algorithm (NSGA-II) and multi-objective particle swarm optimization (MOPSO) to address the complex problem of disruptive RMS. The contributions offered by this study can be summarized as follows:

- The analysis of quality variation is embedded in the RMS process planning. Further, a novel index of modularity is proposed which considers the lost efforts.
- A multi-objective mixed integer non-linear programming (MINLP) model is presented to analyze cost, quality decay, and modularity effort in RMS process plan. Due to quality concerns, novel scrap and re-work costs are considered in the cost model.
- A hybrid meta-heuristic combining the strengths of non-sorting genetic algorithm (NSGA-II) and multi-objective particle swarm optimization (MOPSO) is implemented. The performance of different approaches is assessed by using two metrics and two termination criteria.

- An industrial case study is used to validate the model.

The rest of the study is organized as follows: Section 2 provides the literature related to quality and cost. Section 3 describes the problem statement where a disruptive RMS is analyzed by considering the assignable causes of variation. Section 4 contains the mathematical model of cost, quality, and modularity. Section 5 offers the exact and hybrid meta-heuristic solution approaches. Section 6 presents the results concerning various aspects of the problem. Finally, Sect. 7 draws the conclusion and offers suggestions for future research.

2 Literature review

The literature on RMS can be analyzed from different viewpoints. As the focus of current study is on quality and cost, in the below section, literature is reviewed according to these aspects.

2.1 Quality performance assessment

The measurement of quality in a manufacturing system depends on many factors. These factors comprise the identification of key characteristics (KCs) responsible for most variation, the importance of KCs in a manufacturing system, and complexity of the system. The identification and selection of KC are pertinent as it significantly and negatively affects the performance of a product. The literature contains various qualitative and quantitative approaches to analyze the variation in quality of manufacturing systems. These approaches are discussed in the following sub-sections.

2.1.1 Qualitative approaches toward quality assessment

The aim of qualitative approaches is to accumulate the engineering knowledge available in a manufacturing system. This knowledge helps in brainstorming toward the causes of variation and implementing remedial actions. There are different qualitative approaches in the form of failure mode and effect analysis (FMEA) and root cause analysis (RCA) which logically link the variation and failures with their respective causes/sources [8, 9]. As a result, a tree or cause and effect diagram is used to highlight the KCs and their impact on product usability. Compared to the qualitative approaches, this study offers a quantitative measure for the assessment of quality to help in the selection of a process plan. As a result of the detailed process plan, points can be identified where more effort is needed. In addition, the proposed quality index helps in changing the architecture, manufacturing processes, and resources to achieve better results.

2.1.2 Quantitative approaches toward quality assessment

The literature contains variation in quality indices which have been quantitatively analyzed by using different approaches. For example, quality loss function (QLF), quality function deployment (QFD), stream of variation analysis (SOVA), and statistical process control (SPC) have been used [10, 11]. Variation in quality can also be analyzed by using maximum deviation, root mean square deviation, fraction of non-conforming items, and/or based on a metric outlining customer expectation [11].

A noteworthy contribution toward the assessment of quality variation is Taguchi's quality loss function (QLF). It focuses on achieving a specific target value. The costs in QLF, however, may not be accurately estimated due to intangible cost factors such as customer dissatisfaction [12]. Another approach to measure the variation in quality is the traditional process capability index given by $c_p = T/6\sigma$. It measures the ratio of dispersion to tolerance. Though it helps in comparing and selecting a process plan, it lacks more in-depth knowledge (e.g., the impact of different defects, number of conforming and failed units).

In literature, focus has been given to the identification of causes of variation as opposed to offering indices for measuring its impact on the system's performance. For example, Loose et al. [13] presented a variation source identification methodology to identify the causes of variation. In some cases, raw sensitivity is used to analyze the cause of variation, i.e., by taking partial derivative of effect variables w.r.t. variables that cause variation. It helps in identifying the variables/characteristics which are critical in the performance of a product. Design of experiments (DOE), Monte Carlo simulation, variation resource management (VRM), and Pareto analysis are some of the analysis tools used to identify the causes of variation [14]. There are also certain contributions to analyze the effects of variation on the performance of system, prioritizing KCs and analyzing the cost of variation [15, 16]. An important approach is the stream of variation analysis (SOVA) for predicting the performance of multi-stage manufacturing systems. The SOVA uses a state-space model for representing the KC [10].

Though different contributions have been offered toward variation in quality analysis, focus has been given to the identification of KC. On the other hand, this study assesses the impact of "variation in KC" on the performance of RMS. The sub-sections below present a more focused review on the analysis of quality in flexible manufacturing system (FMS) and RMS. The former has been selected due to its resemblance with RMS, in terms of flexibility and responsiveness.

2.2 The analysis of quality in FMS

The FMS literature contains qualitative and quantitative approaches for the assessment of quality. For instance, Hsu and

Tapiero [17] introduced process quality control for FMS and considered various cost components. An important assumption was that all the defective items were scrapped, and hence, the re-work of such items was not considered. A fuzzy multi-objective approach was presented in [18] to assist in the selection of FMS. The objective of quality was defined in terms of a qualitative measure, i.e., weak, fair, and good quality. In another study, Li and Huang [19] analyzed the probability of good parts in FMS.

Souier et al. [20] studied the real-time part routing problem in FMS. They analyzed the objectives of workload balancing and reliability. The study did not quantify the number of failed units due to reliability issues or the costs related to sub-optimal performance of the system. It can be argued that quality in FMS has been defined either in terms of cost or in terms of a qualitative measure (i.e., weak/fair/good quality or probability of good parts). It is beneficial to know the quantitative impact of variation in quality such as the number of conforming and failed units, which is the proposition of current study.

2.3 The analysis of quality in RMS

A manufacturer selects certain resources and evaluates their impact on the product key characteristics (KCs). These resources are changed if improvement in quality is required and the analysis is repeated. The process of selection of resources is not difficult for a relatively less complex manufacturing system. RMS involves the selection of machines, configurations, modular features, tools, and TADs, along with the greater number of possible production routes. Thus, it becomes more difficult to analyze the impact of each resource on KC's performance.

To some extent, a discussion has been made on quality in RMS. A theoretical perspective on different performance measures in RMS, namely cost, reliability, utilization, and quality, was provided in [21]. The measure of quality was defined as an average of utilization and reliability. It did not provide a model or solution regarding quality assessment and its associated variation. More recently, Koren et al. [5] compared different manufacturing systems including serial-line-in-parallel (SLP) and RMS. The comparison was carried out based on cost, responsiveness, and quality. It called for a more attentive focus toward the assessment of quality in RMS due to its complex structure.

There are six (6) key requirements for a stable system such as design, quality, delivery, and cost [22]. The quality requirement needs the production to be completed within defined tolerances which can be achieved by eliminating the assignable causes of variation. Although RMS literature fulfills the requirements of design, cost, etc., it still lacks in analyzing the causes of variation to comply with the quality requirement.

This study translates quality variation in RMS process plan into the efficiency of process elements (PE) by using failure

rates. PE is the characteristic of a manufacturing system which affects the KC of a product. It comprises of machining, tooling, production schemes, cutting condition, etc. The PE defines the “assignable” causes responsible for the variation in quality of product KCs. The assignable causes selected in this study are disruption of machines, tolerance-related issues, and tooling errors. To this end, this study proposes a quantitative index for the assessment of quality in RMS. This index will help a decision-maker (DM) in selecting a process plan with minimum variation, defects, and number of failed products.

2.4 The analysis of cost in RMS

The analysis of cost can be observed in many publications related to RMS. At times, single cost function has been considered and/or the amalgamation of several cost factors to assess the behavior of RMS. The most opted cost function for designing the RMS is production cost [23–25]. Deif et al. [26] defined the cost function for RMS which comprised of two components. The first reflected the physical capacity cost for scaling the system, while the second component was associated with reconfiguration of the system. Dou et al. [27] analyzed a multi-part flow line problem in RMS for part family. An integer programming model was developed to optimize the capital cost by using genetic algorithm (GA) as a solution approach. Goyal et al. [23] solved the optimal configuration selection problem in RMS. A multi-objective model was solved to acquire non-dominated solutions by using non-sorting genetic algorithm (NSGA-II) which were subsequently ranked. The objective of cost was based on production cost of reconfigurable machines.

Chaube et al. [28] used an adapted version of NSGA-II to analyze the cost and time of RMS. The cost components used were machine cost and configuration cost related to machine and tools. Saxena and Jain [29] analyzed the costs of investment, reconfiguration, operation, and salvage value for RMS configuration design problem. The model was implemented on different case studies by using a Loerch algorithm. Haddou Benderbal et al. [30] studied modularity in RMS by using the archived multi-objective simulated annealing (AMOS) approach. The objectives of cost, time, and system modularity were analyzed. The objective of cost was based on configurations, modules, and machine exploitation costs. In another study, a sustainable process planning problem was analyzed using the objectives of cost, time, and greenhouse gas emissions [31]. The model was implemented through exact and adaptive meta-heuristic approaches. Dou et al. [32] developed a mixed integer linear programming model to optimize the cost and tardiness of RMS. The objective function of cost contained capital cost and reconfiguration cost of a reconfigurable flow line. An exact solution approach was used to validate the model through benchmark instances. Moghaddam et al. [24] studied the capital expansion cost for scalable configuration design in RMS. A mathematical model was presented to

analyze the cases of single production flow line and part family design. More recently, Khezri et al. [33] proposed a multi-objective model for addressing sustainability concerns in RMS. The objective function of cost considered the costs related to production and disposal of waste and greenhouse gases (GHG).

To summarize, the costs related to capital, production, configurations, modules, transportation, installation, and energy consumption have been analyzed. Till date, the concerned literature lacks in analyzing the costs related to variation in quality. RMS is prone to defects due to variation in quality, just like any other manufacturing system. Thus, it is important to control the costs related to variation against improved quality for a manufacturing system to perform cost-effectively [34]. In other words, a balance needs to be warranted between cost-quality trade-off by performing a combined assessment of both. The analysis of variation in quality can help a manufacturing system to identify the sources of variability and ensure a smaller number of defects and lower cost. The costs related to variation in quality can be expressed in the form of repair, warranty claims, scrap, inspection, disruption, under-utilized manufacturing capabilities, etc. [15]. Besides other cost factors, this study analyzes the costs related to scrap, re-work, and disruptive performance of machine in the selection of a process plan.

The summary of RMS literature is presented in Table 1 with respect to different criteria. The following research gaps can be identified:

- i) The performance of RMS has been analyzed against the cost factors of production (P), machine exploitation (E), and configuration (C) costs. However, the costs related to quality issues such as scrap (S) and re-work (R) costs have not been analyzed in the literature of RMS process planning.
- ii) None of the studies has analyzed the issues related to quality and disruptive performance of machine. The combined assessment of cost and quality can provide insights on how cost decisions can be impacted by the quality of production.
- iii) In terms of single heuristic, non-sorting genetic algorithm (NSGA-II) has been used more often. There is a dearth of application of powerful hybrid meta-heuristics. This study uses a hybrid version of NSGA-II and MOPSO. The solution approaches are assessed by using two performance metrics and two termination criteria.

3 Problem statement

This section discusses the statement of considered problem. An RMS with production stages designed in series is analyzed where each production stage contains one machine

Table 1 Summary of RMS literature according to selected criteria

Authors	Process planning	Objectives					Machine disruption	Solution approaches			
		Cost			Time	Quality		Exact	Heuristic	Multi-heuristic	Hybrid
		P	E	C	S	R					
Deif and ElMaraghy [26]	■		■					GA			
Dou et al. [27]	■			■				GA			
Chaube et al. [28]	■		■	■		■		NSGA-II			
Goyal et al. [23]	■		■					NSGA-II			
Bensmaine et al. [35]	■		■	■		■		NSGA-II			
Mohapatra et al. [36]	■		■	■				NSGA-II			
Hasan et al. [37]				■							
Dahane and Benyoucef [38]	■		■			■		NSGA-II			
Haddou Benderbal et al [30]	■					■		NSGA-II			
Ashraf and Hasan [39]	■		■					NSGA-II			
Benderbal et al. [40]	■		■	■		■		AMOSA			
Liu et al. [41]				■				e-constraint			
Touzout and Benyoucef [25]	■		■	■		■		I-MOILP		NSGA-II	AMOSA
Touzout and Benyoucef [25]	■		■	■		■			NSGA-II		RSUPP ILSSUPP ABILS
Pal Singh et al. [42]	■		■	■					AHP		
Dou et al. [43]	■			■				e-constraint	NSGA-II		
Dou et al. [32]				■		■		e-constraint		NSGA-II	MOPSO
Prasad and Jayswal [44]				■					AHP		
Khezri et al. [33]	■		■	■		■		AUGECON		SPEA	NSGA-II
Moghaddam et al. [24]				■				GAMS			

Cost components: P, production cost; E, exploitation cost of machine; C, configuration cost; S, scrap cost; R, re-work cost

GA genetic algorithm, NSGA-II non-sorting genetic algorithm, AMOSA archived multi-objective simulated annealing, AHP analytical hierarchical process, MOPSO multi-objective particle swarm optimization, SPEA strength Pareto evolutionary algorithm, RSUPP repetitive single unit process plan meta-heuristics, ILSSUPP iterated local search on single-unit process plan meta-heuristic, ABILS archive-based iterated local search meta-heuristic, AUGECON augmented e-constraint.

configuration which can perform one or more operations. A normal RMS works well and converts all input operation units into usable output. This means that the number of input units is equal to the number of output units. However, in the presence of variation and defects, the quality of operations is impacted. Thus, part of the operation units is discarded as scrap due to poor quality, while remaining units are re-worked to make them conform. As shown in Fig. 1, initially raw material units ($\eta_{i,o}$) are processed on machine configuration i to perform operation o . Configuration i exhibits quality variation which results in the failed units of operations. Inspection is performed after each production stage, and after discarding the failed units as scrap, remaining units are re-worked, and then fed to subsequent machine configuration, and so on. The failed operation units are generated in between every two successive configurations, and these are removed, and the remaining are re-worked after each machine configuration. It can be observed from the curve given in Fig. 1 that each configuration keeps on reducing the quantity of conforming products due to different defects. At the end of the process plan, part of the products entering the RMS are conforming, while remaining are discarded as scrap. The goal is to select a

process plan which warrants a higher number of conforming products along with minimum cost and minimum modular effort. The conforming products, cost, and modular effort are conflicting objectives. For instance, to produce higher number of conforming products, scrap and re-work costs and lost modular efforts need to be minimized. On the other hand, a system bearing higher defects will have more scrap cost, re-work cost, increased level of lost modular efforts, and a smaller number of conforming products. A trade-off between these objectives can be achieved by appropriately designing a process plan. This can be done by assigning those machine configurations to different operations which can enhance the level of conforming products by minimizing the total cost and modular efforts.

As variations are inevitable, an RMS process plan will be preferred with a fewer number of failed operation units and a higher number of conforming operation units. In a contrary situation, the process plan will result in a higher number of failed units and an increased value of scrap cost. The variation in quality can be attributed to the assignable causes of manufacturing system which are discussed below.

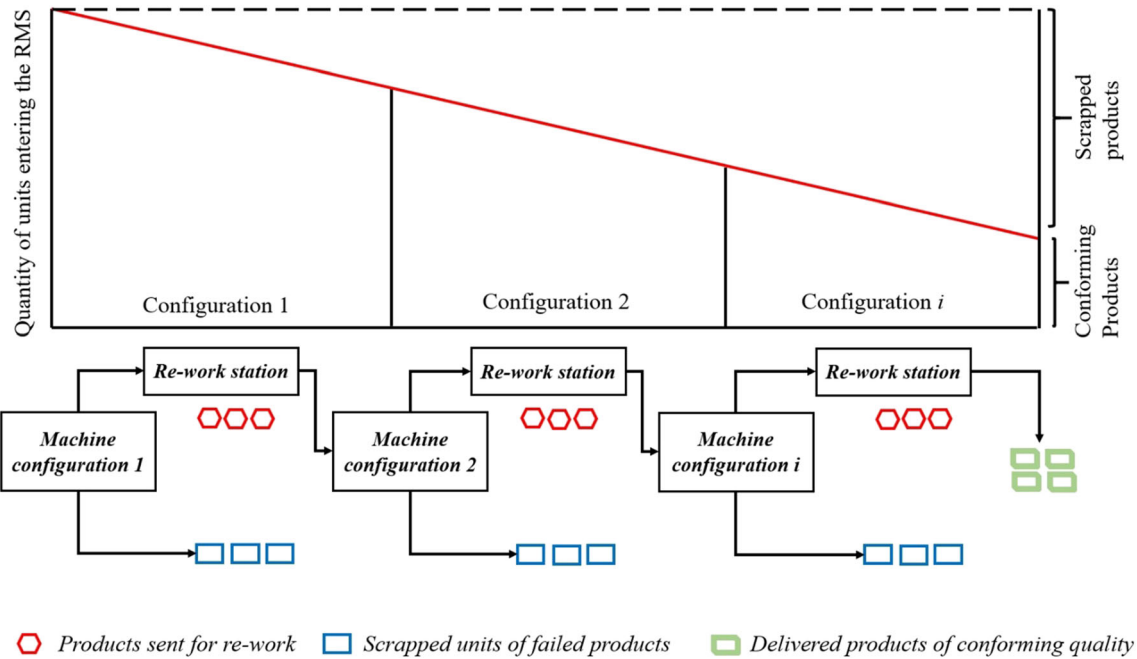

Fig. 1 Process flow of considered RMS

3.1 The assignable causes of quality variation

The causes of variation of PE are explained with the help of a manufacturing system design decomposition (MSDD) tree. The MSDD decomposes the overall objectives of a manufacturing system (MS) into measurable sub-components. The effective control of these sub-components demonstrates how well the MS has achieved its designed objectives. The decomposition of objectives of MS is performed by using the functional requirements (FR) and design parameters (DP). MS defines certain FRs to help answer “what to achieve.” Once the “what” question is answered, DPs are used to address “how to achieve the FRs.” In other words, DP constitutes the physical implementation of FR. The application of MSDD to RMS can be interesting as they both work on the principle of decomposing a system into sub-systems/modules.

A modified version of figure from the study of Cochran et al. [45] is used to explain the selection of causes of variation (Fig. 2). For an easy understanding, the FRs and DPs in the given MSDD are divided into different levels. At level 1, the objective is to maximize revenue/minimize cost (FR) which is achieved through customer satisfaction (DP). At the 2nd level, FRs are “manufacture products to target design specification” and “deliver products on time.” Since the current analysis is based on quality and not time, we focus on the left side of the MSDD tree. The production can be performed within design specifications by warranting minimal variation in the processes (DP). At level 3, the FR is to achieve process stabilization which can be achieved by eliminating the assignable causes of variation (DP). Lastly, at the 4th level, the goal is to eliminate the assignable causes related to machines, operators, methods/

processes, and materials. The former three are related to production processes, while the latter is concerned with pre-production (acquiring raw material). Thus, we focus on eliminating the assignable causes of the first three factors. We posit that by controlling these causes, the ultimate objective of a MS, i.e., to minimize cost (or to enhance quality), can be achieved. The variation in quality due to these causes results in defects. The causes of such defects are explained below.

3.1.1 Controlling the disruptions due to maintenance

The cause of machine-based defect is poor maintenance which results in the disruptive performance of machine. Each machine works perfectly well in the start of production (control state) and produces optimal quality goods by performing a set of operations. However, due to maintenance issues, a disruption is observed in its performance. Due to it, the machine goes into an out-of-control state, resulting in variation in quality. Thus, it performs a mix of good quality operations and failed operations.

3.1.2 Training of workers

An inadequate level of training offered to workers can lead to tooling error which results in poor finish, wear and tear, etc. Each operation is specified by a quality characteristic k . The variation in quality occurs when k acquires defect at the level of tool due to an error attributed to worker training.

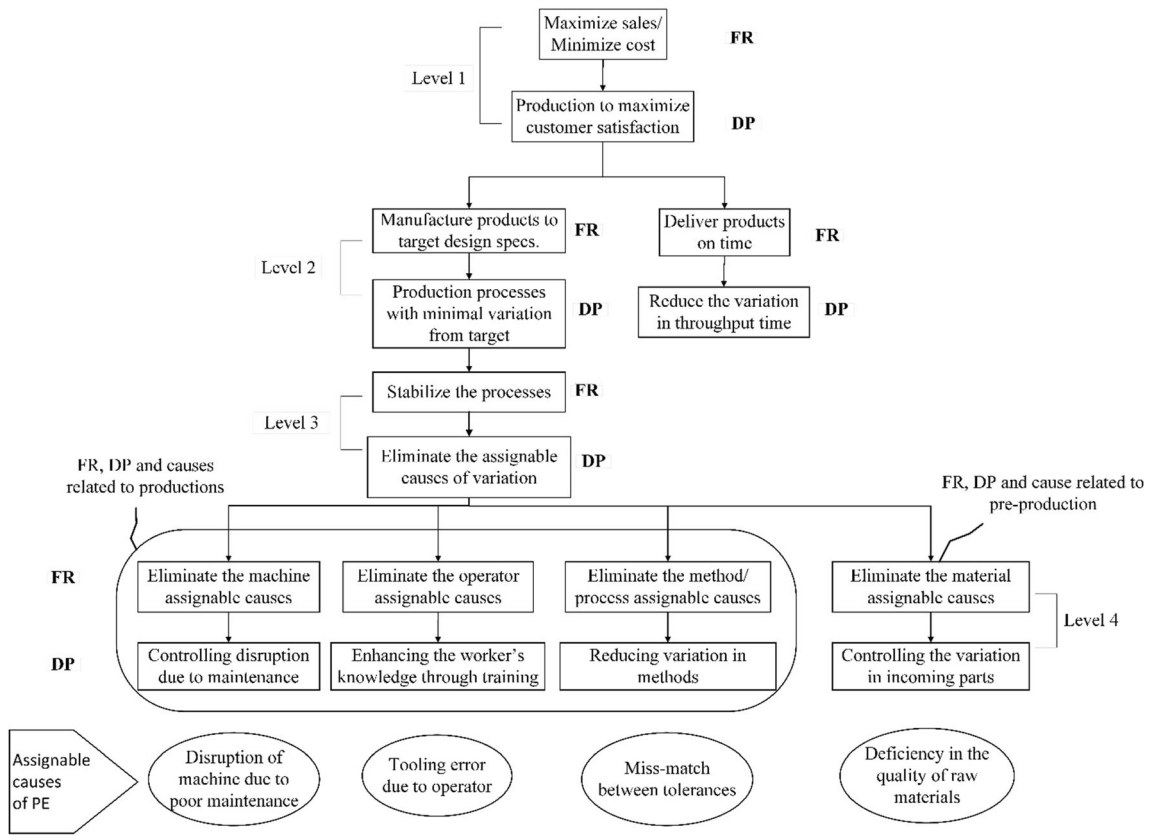

Fig. 2 Manufacturing system design decomposition (MSDD) for assignable causes of quality variation [45]

3.1.3 Reducing variation in methods/processes

A manufacturing system matches the process capabilities of machine with the product requirements. Due to mismatch, the process-based defects will occur which can harm the health of products. The cause of process-based defects is due to the mismatch of tolerances between an operation and a machine. Each operation is specified by the required level of tolerance which needs to be less than or equal to the tolerances offered by a machine. In a contrary situation, a tolerance-related variation occurs which also results in a failed operation.

The aim is to design a reconfigurable manufacturing system with minimum waste, minimum failed operations, minimum cost, and minimum loss in modular effort. The following section offers the mathematical model.

4 Mathematical model

A multi-objective mixed integer non-linear programming (MINLP) model is presented in this section to optimize the objectives of total cost (TC), quality decay index (QDI), and modularity efforts (ME). The MINLP is subsequently converted into a linear model by using the linear approximation technique. The analysis is performed by using two models to highlight the effect of defects and quality decay on the

selection of a process plan. In model 1, the decay in quality is acknowledged, and three objective functions, i.e., TC, QDI, and ME, are used as evaluation criteria. Model 2 does not consider any decay in quality, and a perfectly working RMS is examined by using the objective functions of TC and ME.

The parameters, decision variables, and objective functions related to the process planning problem are given below:

Indexes

i, i'	Index for machine configuration; $i, i' = \{1, 2 \dots I\}$
f	Index for product features; $f = \{1, 2 \dots F\}$
o, o'	Index for operations; $o, o' = \{1, 2 \dots O\}$
t	Index for tools; $t = \{1, 2 \dots T\}$
m, m'	Index for modules; $m, m' = \{1, 2 \dots M\}$
k	Index for quality characteristic; $k = \{1, 2 \dots K\}$

Parameters

I	Total number of machine configurations
F	Total number of product features

O	Total number of operations
T	Total number of available tools
M	Total number of available modules
K	Number of quality characteristics associated with different operations
fr_{kt}	Failure rate of quality characteristic k due to tooling error
t_{oi}	Failure rate of operation o on machine i due to tolerance error
xk_{ko}	1, if quality characteristic k belongs to operation o ; otherwise, 0
η_0	Quantity of operations o entering the RMS
ca_{io}	Production rate of machine i for operation o
ec_i	Exploitation cost of machine i
λ_i	Failure rate of operation due to machine disruption
f_I	Conforming fraction of operations passed through inspection
$1-f_I$	Non-conforming fraction of operations passed through inspection
Ψ	Probability of type I error due to inspection
$dx_{oo'}$	1, if operation o and o' are dependent; otherwise, 0
pc_o	Processing cost of operation o
$rcp_{ii'}$	Reconfiguration cost between machines i and i'
sc_o	Scrap cost of defective operation o
rwc_o	Re-work cost of conforming operation
rnc_o	Re-work cost of non-conforming operation
t_f^o	Processing time of operation o of feature f
ft	Total processing time of feature f
$at_o^{m,i}$	Module addition time of module m on machine i for operation o
$st_{o,o'}^{m,m',i}$	Time needed to change from module m to m' on machine i between ops
$rt_{o,o'}^{m,i}$	Time needed to adjust module m on machine i from op o to o'
TAD[i]	Matrix of tool approach directions offered by machines
TAD[o]	Matrix of tool approach directions needed by operations
d_o	Required level of operation o ($d_1=d_2=d_o=d$)

Decision variables

XM_{io}	1, if operation o is assigned to machine i ; otherwise, 0
η_{io}	Number of operation units entering machine i
ω_{io}	Number of failed operation units of o on machine i
ω	Total number of failed operation units at the end of the process plan
PN_{io}	Number of conforming units of operation o on machine i
PN	Total number of conforming operations at the end of the process plan

NM	Number of machine configurations (copies) required for production
$xo_{oo'}^i$	1, if operations o and o' are performed on same machine i ; otherwise, 0
$y_{o,o'}^{m,i}$	1, if machine i requires module m for operation o (o'), otherwise 0
$cy_{o,o'}^{m,m',i}$	1, if between op o and o' , there is a change of module from m to m' , otherwise, 0

4.1 Model 1

4.1.1 Quality decay index

A unique index called quality decay index (QDI) is introduced in (1). It is the ratio of failed operation units to conforming operation units.

$$QDI = \frac{\omega}{PN} \quad (1)$$

A higher QDI value means that, out of the total processed units, the proportion of failed units is high, as compared to the proportion of conforming units. On the other hand, a lower QDI value will imply that the proportion of failed units is less than the proportion of conforming units. It is to be noted that the sum of the number of failed units and conforming units equals the total number of processed units. A process plan with a minimum QDI value is preferred as it warrants minimum number of failed operation units.

The total number of failed operation units produced by a process plan is calculated using (2). The total number of conforming operations is given in (3). The expressions for number of failed and conforming units of operations o are given in (4) and (8), respectively.

$$\omega = \sum_{o=1}^O \sum_{i=1}^I \omega_{io} \quad (2)$$

$$PN = \sum_{o=1}^O \sum_{i=1}^I PN_{io} \quad (3)$$

$$\begin{aligned} \omega_{io} &= FO_i + FO_p + FO_t; \quad \forall i = \{1, 2, \dots, I\}; \forall o \\ &= \{1, 2, \dots, O\}; \quad \lambda_i = \lambda \end{aligned} \quad (4)$$

The relationship in (4) sums the failed operations respectively due to machine (FO_i), tolerance (FO_p), and tooling-based defects (FO_t). Since the sources of defects are different, one of the assumptions of our model is that these defects are independent of each other. In line with this assumption, the failed operation units due to these defects are independently calculated (5, 6, 7).

$$\begin{aligned} FO_m &= XM_{io} \cdot \lambda_i \cdot \eta_{io} \cdot t_f^o; \quad \forall i = \{1, 2, \dots, I\}; \\ \forall o &= \{1, 2, \dots, O\}; \quad \lambda_i = \lambda \end{aligned} \quad (5)$$

$$FO_p = XM_{io} \cdot t_{oi} \cdot \eta_{io} \cdot t_f^o; \quad \forall i = \{1, 2, \dots, I\}; \quad \forall o = \{1, 2, \dots, O\}; \quad (6)$$

$$FO_i = XM_{io} \cdot f_{kt} \cdot xk_{ko} \cdot \eta_{io} \cdot t_f^o; \quad \forall i = \{1, 2, \dots, I\}; \quad \forall o = \{1, 2, \dots, O\}; \quad (7)$$

$$PN_{io} = XM_{io} \cdot (\eta_{io} - \omega_{io}); \quad \forall i = \{1, 2, \dots, I\}; \quad \forall o = \{1, 2, \dots, O\} \quad (8)$$

4.1.2 Total cost (TC)

The relationship of TC contains the production cost (PC), total machine exploitation cost (TMC), scrap cost (SC), re-work cost (TR), and reconfiguration cost (RC) (9).

$$TC = PC + TMC + SC + TR + RC \quad (9)$$

The respective relationships for these costs are provided by Eqs. 10, 11, 12, 13, and 14.

$$PC = \sum_{i=1}^I \sum_{o=1}^O XM_{io} \cdot \eta_{io} \cdot pc_o \quad (10)$$

$$TMC = \sum_{i=1}^I \sum_{o=1}^O XM_{io} \cdot ec_i \cdot NM \quad (11)$$

$$SC = \sum_{i=1}^I \sum_{o=1}^O sc_o \cdot \omega_{io} \quad (12)$$

$$TR = \sum_{i=1}^I \sum_{o=1}^O XM_{io} \cdot f_1 \cdot (1 - \Psi) \cdot rwc_o \cdot (\eta_{io} - \omega_{io}) \\ + \sum_{i=1}^I \sum_{o=1}^O XM_{io} \cdot (1 - f_1) \cdot (1 + \Psi) \cdot rnc_o \cdot (\eta_{io} - \omega_{io}) \quad (13)$$

$$RC = \sum_{o,o'=1}^O \sum_{i,i'=1}^I rcp_{i,i'} \cdot (1 - x_{oo'}^i); \quad o < o' < O; i < i' < I \quad (14)$$

PC calculates the total production cost of a process plan by considering the number of units of operation o entering machine configuration i . TMC calculates the cost related to the number of machines in use. After each production stage, the processed operation units can be divided into scrap units, conforming units, and non-conforming units. Scrap units refer to those operations which are in worst quality, and the manufacturing system cannot improve their quality, and hence such units are discarded. Conforming units are those units which can be brought to an optimal quality level by re-working. On the other hand, non-conforming operation units have quality in between conforming and scrap units. The quality of non-conforming units can be improved by extensively re-working them.

SC calculates the total scrap cost of a process plan. All the non-scraped operation units are inspected and re-worked to bring them to an optimal quality level. As explained, some operation units need little re-work (conforming to higher extent), while others are in bad quality and need an extensive amount of re-work (non-conforming units). Due to it, the re-work cost (TR) expression considers the costs of re-work of conforming and non-conforming operation units.

Furthermore, portion of such operation units are relatively of improved quality, yet they are extensively re-worked, due to type I inspection error. It means that some of the conforming units are allocated to non-conforming units due to misjudgment. Lastly, RC considers the involved cost if reconfiguration is required between respective triplets.

4.1.3 Modularity effort (ME)

Unlike the traditional manufacturing systems, RMS can perform a variety of operations by using the same machine. It achieves so by reconfiguring its existing modules according to the requirements of an operation. The process of reconfiguration from existing machine configuration to a new configuration requires modular effort (time of changing modules, etc.). We argue that this time is a non-productive part of the overall processing time, and thus it should be minimized. Also, since part of the operations are discarded due to quality variations, the effort of using modules in processing such operations is also wasted. To encapsulate such behavior, we propose an index called modularity effort (ME) in (15). It combines the non-productive effort (proportion of time) to change (add, subtract, and re-adjust) the auxiliary modules and the proportion of effort wasted due to failed operations. The non-productive time of modular change is considered with respect to the operation time of a particular operation. Similarly, the non-productive time of modular efforts on failed operations is considered with respect to the operation time of the entire feature.

$$ME = \sum_{f=1}^F \sum_{m=1}^M \sum_{o,o'=1}^O y_{o,o'}^{m,i} \cdot \frac{at_{o'}^{m,i}}{t_f^o} \\ + \sum_{f=1}^F \sum_{m,m'=1}^M \sum_{o,o'=1}^O cy_{o,o'}^{m,m',i} \cdot \frac{st_{o,o'}^{m,m',i}}{t_f^o} \\ + \sum_{f=1}^F \sum_{m=1}^M \sum_{o,o'=1}^O y_{o,o'}^{m,i} \cdot \frac{rt_{o,o'}^{m,i}}{t_f^o} \\ + \sum_{f=1}^F \sum_{i=1}^I \sum_{o=1}^O XM_{io} \cdot \omega_{io} \cdot \frac{t_f^o}{ft_i} \quad (15)$$

4.2 Model 2

Model 2 examines the process planning problem without any decay in quality. Thus, it does not consider the objective of QDI and only considers the objective functions of TC and ME. In the absence of quality-related issues, the TC relationship considers only PC, TMC, and RC (16).

$$TC = PC + TMC + RC \quad (16)$$

The TMC and RC relationship remains the same, as given in (11) and (14), respectively. For the calculation of PC, an equal number of operation units are processed by each machine configuration as there are no defects in this case. Also, same expression for ME (15) is used by this model; however, the last term of ME is discarded in model 2 as it refers to the failed operation units. The modified ME expression for model 2 is given in (17). It considers the efforts lost in adding, removing, and re-adjusting the modules.

$$\begin{aligned}
ME = & \sum_{f=1}^F \sum_{m=1}^M \sum_{o,o'=1}^O y_{o,o'}^{m,i} \cdot \frac{at_o^{m,i}}{t_f^o} \\
& + \sum_{f=1}^F \sum_{m,m'=1}^M \sum_{o,o'=1}^O cy_{o,o'}^{m,m',i} \cdot \frac{st_{o,o'}^{m,m',i}}{t_f^o} \\
& + \sum_{f=1}^F \sum_{m=1}^M \sum_{o,o'=1}^O y_{o,o'}^{m,i} \cdot \frac{rt_{o,o'}^{m,i}}{t_f^o}
\end{aligned} \quad (17)$$

s.t

$$\eta_{i1} = \eta_0 \quad (18)$$

$$\eta_{(i+1)o'} = \eta_{io} - \omega_{io}; \quad o < o' < O, \forall i = I \quad (19)$$

$$\eta_{io} = \eta_0 \quad \forall o = O, \forall i = I \quad (20)$$

$$NM \geq \frac{d_o}{XM_{io} \cdot (ca_{io} - \omega_{io})}; \quad \forall i = I, \forall o = O, \quad d_o = d \quad (21)$$

$$NM \geq \frac{d_o}{XM_{io} \cdot ca_{io}}; \quad \forall i = I, \forall o = O, \quad d_o = d \quad (22)$$

$$\sum_{o=1}^O xk_{ko} = 1; \quad k = \{1, 2, \dots, K\} \quad (23)$$

$$\sum_{i=1}^I XM_{io} = 1; \quad o = \{1, 2, \dots, O\} \quad (24)$$

$$dx_{oo} \in \text{Prec}[O_o][O_{o'}] = 1; \quad o < o' < O \quad (25)$$

$$TAD[i].TAD[o] = 1; \quad \forall i = I, \forall o = O \quad (26)$$

$$NM \in \mathbb{Z}^+ \quad (27)$$

$$TC, PC, SC, RC, TR, TMC, QDI, \eta_{io}, \omega_{io}, \omega, PN_{io}, PN \geq 0 \quad (28)$$

$$XM_{io}, xo_{oo}^i \in \{0, 1\} \forall o, o' = O, \forall i = I \quad (29)$$

The set of constraints is provided by Eqs. 18, 19, 20, 21, 22, 23, 24, 25, 26, 27, 28, and 29. Some of these constraints are specific to either model 1 or model 2, while remaining are equally applicable to both models. Eqs. 18 and 19 are, respectively, for the number of units entering into first and successive triplets in model 1. Since there are no defects in the case of model 2, hence, same numbers of units are fed to each triplet. This is equal to the number of units entering the RMS (20). Eqs. 21 and 22 calculate the number of machines (NM) to produce the required level of demand for model 1 and

model 2, respectively. Its value is obtained as the ratio of demand to production rate. Equation 23 designates a particular quality characteristic to one operation (model 1 specific).

The remaining constraints (24–29) are applicable to both models. Equation 24 ensures that a particular operation is to be performed by one triplet. Equation 25 is to respect the precedence order. Equation 26 requires the tool approach direction (TAD) compatibility between a triplet and an operation. The number of machines can only take integer values (Eq. 27). Lastly, the domain constraints of non-negativity and binary variables are provided, respectively, by Eq. 28 and Eq. 29.

The presented model is non-linear as it contains the product of integer and continuous variables (e.g., Eqs. 1, 8, 15, 21, and 22). It is converted into a linear model by using the linear approximation technique. The general form of linearization is provided in Table 2. It contains a non-linear product of variables B and C which is linearized by using an auxiliary variable A and a big number Z. As an illustration, the linearization of non-linear product $XM_{io} \cdot \eta_{io}$ (Eq. 10) is also provided.

5 Solution approaches

5.1 Complexity of model

The RMS process planning is a complex problem, and it belongs to the non-polynomial hard (NP-hard) set of problems. The complexity of RMS is due to the combination of machines, configurations, tools, modules, and tool approach directions (TADs) to perform an operation of a feature. The resulting graph is an acyclic graph which can be seen in the case study diagram. Further, the problem can be converted into a traveling salesman problem (TSP) if the complexity of machines, configurations, and tools to perform an operation is removed. Thus, exact solution approaches are not ideal techniques to solve such problems, especially when the problem is of large size. To understand the behavior of different solution approaches, this study considers the application of ε -constraint as an exact technique, non-sorting genetic algorithm (NSGA-II), multi-objective particle swarm optimization (MOPSO), and hybrid NSGA-II-MOPSO as evolutionary techniques. Furthermore, the performance of different

Table 2 Linearization of non-linear products

General form	Eq. 10
$A = B \cdot C$	$XNT = XM_{io} \cdot \eta_{io}$
$A \leq B$	$XNT \leq XM_{io}$
$A \leq Z \cdot C$	$XNT \leq Z \cdot \eta_{io}$
$A \geq B - Z(1 - C)$	$XNT \geq XM_{io} - Z(1 - \eta_{io})$

approaches is tested by using two metrics and two termination criteria.

5.2 Exact solution approach

This approach converts a multi-objective model into a single/mono-objective model by converting all objectives (except one) into constraints. This approach was applied to model 1. The objective of TC is given an utmost priority, as it constitutes an integral part of the process planning decision. The remaining objectives of QDI and ME are converted into ε -constraints. The additional set of equations and constraints are given as:

$$\min TC \quad (30)$$

$$QDI \leq \varepsilon_1 \quad (31)$$

$$(QDI)^{\min} \leq \varepsilon_1 \leq (QDI)^{\max} \quad (32)$$

$$ME \leq \varepsilon_2 \quad (33)$$

$$(ME)^{\min} \leq \varepsilon_2 \leq (ME)^{\max} \quad (34)$$

The pseudocode of adapted ε -constraint is given in Algo. 1. ΔQDI is the difference of quality decay index values between the current and the previous steps. Similarly, ΔME is based on the difference of modularity effort values between the current and the previous steps of an ε -constraint method. A distinct number of solutions are generated until the threshold defined by ε -constraints is reached.

Algo. 1 Pseudocode of adapted ε -constraint

- 1: Input: data
 - 2: Implement the Model 1 in CPLEX for upper and lower bounds of QDI and ME.
 - 3: Use (32) and (34) to adjust ε_1 and ε_2 between respective upper and lower bounds.
 - 4: **While** $\varepsilon_1 < QDI$ and $\varepsilon_2 < ME$ **do**
 - 5: Use GA to obtain non-dominated solutions of mono-objective TC.
 - 6: Archive the non-dominated solutions.
 - 7: Set $\varepsilon_1 = \varepsilon_1^\circ - \Delta QDI$ and $\varepsilon_2 = \varepsilon_2^\circ - \Delta ME$ (where $\varepsilon_1^\circ > \varepsilon_1$ and $\varepsilon_2^\circ > \varepsilon_2$).
 - 8: **End While**
 - 9: Display the non-dominated solutions.
 - 10: **Stop**
-

5.3 Evolutionary solution approaches

This section introduces the hybrid meta-heuristic which combines the strengths of two powerful meta-heuristics, i.e., multi-objective particle swarm optimization (MOPSO) and non-sorting genetic algorithm (NSGA-II). These approaches have been separately applied to different RMS problems. For example, the application of MOPSO can be found in [43, 46],

while NSGA-II has been used in [28, 38]. Since each algorithm offers certain advantages in computation, the aim is to reinforce the positive aspects of each approach by combining them. For this purpose, the hybrid approach works in a way that NSGA-II is used for the purpose of exploration while MOPSO performs the task of exploitation.

The particle swarm optimization (PSO) was proposed by Eberhart and Kennedy [47]. It is a single objective-based optimization algorithm. PSO is inspired by the behavior of birds flocking and fish schooling. A bird is represented by a particle for single solution, and the set of birds is represented by a swarm. During flight, each particle can be defined in terms of its position (x_{ij}^t) and velocity (v_{ij}^t) which are updated in each iteration of the algorithm. Coello et al. [48] formally introduced MOPSO by incorporating the Pareto dominance and a novel mutation operator. An important aspect of MOPSO implementation is the selection of global best position. In this regard, the same roulette wheel mechanism has been used in the current study as in [46, 48]. It selects the global best position (g_{best}) based on crowding distance (CD). CD computes the closeness of a particular solution about other solutions, and it is based on an average value of distance from two neighboring solutions. In other words, CD offers the density of solutions around a particular solution.

The non-sorting genetic algorithm (NSGA-II) is a non-domination-based technique which is used for multi-objective analysis. It was proposed by Deb [49] and it represents an evo-

lutionary class of algorithms. The advantages offered by NSGA-II are improved sorting, no a priori requirement of sharing parameter, and the inclusion of an elitism approach. It uses the following five operators: initializing, sorting, crossover, mutation, and elitist comparison.

Both algorithms use different search mechanisms. For instance, genetic algorithm uses elitism and crowding distance sorting to ensure diversity of solutions. On the other hand, MOPSO uses a global best particle to guide the movement

of corresponding particles. These particles update their speeds and velocities for searching the solution space. MOPSO has a drawback of getting trapped in local optima. To avoid the local optima, hybrid NSGA-II-MOPSO divides the search space into exploration and exploitation zones. The exploration task is performed by NSGA-II by considering half of the population. This half is improved by the algorithm by using the ranking of non-dominated solutions. The remaining half of the population is used by MOPSO for the purpose of exploitation. It searches for improved solutions in the neighbor by guiding the lower-ranked solutions toward global optimal solution. The flowchart of hybrid algorithm is provided in Fig. 3. The overall procedure of hybrid NSGA-II-MOPSO can be divided into 4 phases, as discussed below.

5.3.1 Phase 1 of hybrid meta-heuristic

It concerns with the input information of RMS and meta-heuristics. This phase evaluates the number of machines (NM) of each configuration which is later used by phases 2 and 3. The pseudocode for NM is given in Algo. 2. An operation is randomly selected, and all feasible configurations are identified by using the machine-operation matrix. The concerned failed operations and configuration capacities are used to calculate the NM values by using Eqs. 20 and 21, and all values are archived. These values are used in phases 2 and 3 during the calculation of objective function values (OBV). During this process, respective configurations and their NM are selected to ensure optimal OBV values.

5.3.2 Phase 2 and phase 3 of hybrid meta-heuristic

The application of phases 2 and 3 is performed by using MOPSO and NSGA-II, respectively. NSGA-II serves the purpose of exploration, while MOPSO performs the task of exploitation. NSGA-II selects the upper half of population to create offspring. It uses a single point crossover and a mutation operator to result in a fresh pair of child chromosomes. Encoding is an important aspect of the application of operators. The encoding matrix of five rows and n columns (machine, modules, features, operations, and quality characteristic) is used, and an example is provided in Table 3. It is interpreted column by column. For instance, machine configuration 1 uses two auxiliary modules (A_{11} and A_{15}) to perform operation 1 (O_1) of feature (F_1) which has the quality characteristic (k_3) and so on. To avoid non-feasible solutions causing penalty, only continuous values between $[0,1]$ are assigned to each cell. Following this, the objective functions of TC, QDI, and ME are computed by using the archived information of number of machines (NM). In the next step, the parent and child population are combined to perform non-dominated sorting and crowding distance based on non-domination of solutions. The solutions are added in an ascending order. Lastly, the non-dominated solutions are stored in an external archive. The remaining half of population is used by MOPSO for exploitation. It acquires the non-dominated solutions which are stored in the repository. Its detailed procedure is provided in Algo. 3.

Algo. 2 Phase 1: Procedure for NM calculation

```

1: Initialize the number of operations ( $o$ )
2: For ( $op$ )  $o \in O$  do
3:   employ the machine operation matrix to identify the feasible machine configurations
4:   while  $i \leq I$ 
5:     If (Prod. Feas.) $_{i,o} = 0$ , (Prec.) $_{o,o'} = 0$  then
6:        $i = i + 1$ 
7:     End If
8:     randomly select ( $op$ )  $o$  based on precedence
9:     input the disruption information of machine  $i$  for ( $op$ )  $o$ 
10:    identify the number of failed units ( $\omega_{i,o}$ )
11:    evaluation of number of machine configurations (eq. 20, 21)
12:     $i = i + 1$ 
13:  End while
14:  archive the number of machine configurations
15: End For

```

Algo. 3 Phase 2: Pseudocode of MOPSO

```
1: select the remaining half of population
2: store  $p_{best}$  values
3: initiate ext. repository and create grid
4: While  $g < g_{max}$  do
5:   For  $p=1-P$  do
6:     select global best from rep. and update speed
7:     evaluate the fitness of OBV values
8:     use MOPSO mutation and perform domination
9:     store  $p_{best}$ 
10:  End For
11: add non-dominated solutions to rep.
12: discard the dominated solutions
13: update grid and change inertia
14:  $g=g+1$ 
15: End While
```

5.3.3 Phase 4 of hybrid meta-heuristic

The 4th phase combines the results of NSGA-II and MOPSO obtained from phases 2 and 3. It takes the population of both algorithms and combines them to be stored in the archive of NSGA-II. The ranking of stored solutions takes place based on non-domination of solution. Only a pre-defined number of non-dominated solutions are stored and remaining are discarded. The loop continues until the optimal solutions are found or the stopping criteria are met. Two stopping criteria are discussed in Sect. 5.4. The pseudocode for merging the population of both meta-heuristics is given in Algo. 4.

The input parameters of the hybrid algorithm were fine-tuned by using a set of experiments. Each experiment was defined by configurations_operations such as 3_5 means 3 configurations and 5 operations. The optimal parameters were based on the following values: population size= 150, maximum iterations= 500, cross-over probability= 0.6, mutation probability= 0.3, $c_1=c_2=2$, size of external archive in MOPSO= 150, maximum inertia= 0.7, and minimum inertia=0.3.

Algo. 4 Phase 4: Merging the population

```
1: For  $g=1$  to  $g_{max}$ , do
2:   create set of particles half the pop. ( $npop/2$ )
3:   add non-dominated solutions to repository
4:   add. pop. NSGA-II with particles of MOPSO
5:   conduct non-dominated sorting
6:   crowding distance calculation
7:   population ranking based on non-domination
8:   divide the population into two groups
9:    $g=g+1$ 
10: End For
11: display the non-dominated solutions
```

5.4 Performance metrics

The results of ε -constraint method and hybrid algorithm were compared to the results of NSGA-II and MOPSO. This comparison was carried out on small and large problem sizes by using two performance metrics, i.e., inverted generational distance (IGD) and hyper volume (HV), and two termination criteria. The termination criteria were based on first improvement (FI) and best improvement (BI). FI returns the solutions when first improvement in the results is found, whereas BI returns the solutions when best improvement in the results is found. The IGD calculates the average distance of non-dominated solutions from a true Pareto front (PF), and it represents the convergence of solutions. The HV calculates the covered space, and a maximum value of HV refers to higher diversity of solutions. These metrics are further discussed below.

- i) The IGD works on improving the quality and uniformity of approximate Pareto solutions (AP). It considers the distance between a real Pareto solution (RS) and an approximate Pareto solution (AP). The equation of IGD is given in (35) where $d(RS(a), AP)$ = Euclidean distance between RS and AP.

$$IGD(AP, RS) = \sum_{a \in F} d(RS(a), AP) / |RS| \quad (35)$$

- ii) The hyper volume (HV) calculates the covered space size between AP and a reference point r . The equation to calculate HV is provided in (36) where $r^* = (r_1^*, r_2^* \dots r_s^*)$ is the set of reference points values, s = number of objective functions, and V = Lebesgue measure.

$$HV(AP) = V \left(U_{a \in AP} [f_1(a), r_1^*] \times [f_2(a), r_2^*] \right. \\ \left. \times \dots \times [f_s(a), r_s^*] \right) \quad (36)$$

A solution with minimum IGD and maximum HV values will ensure an excellent convergence and higher diversity of solutions.

6 Analysis and results

6.1 Model verification

Model 1 was used for comparing the efficiency of different solution approaches. The solution approaches were coded in MATLAB 2016a on a 2.6 GHZ Core i5 system and 8 GB RAM. The results were obtained for small- and large-sized

Fig. 3 Flowchart of 4 phases of hybrid NSGA-II-MOPSO

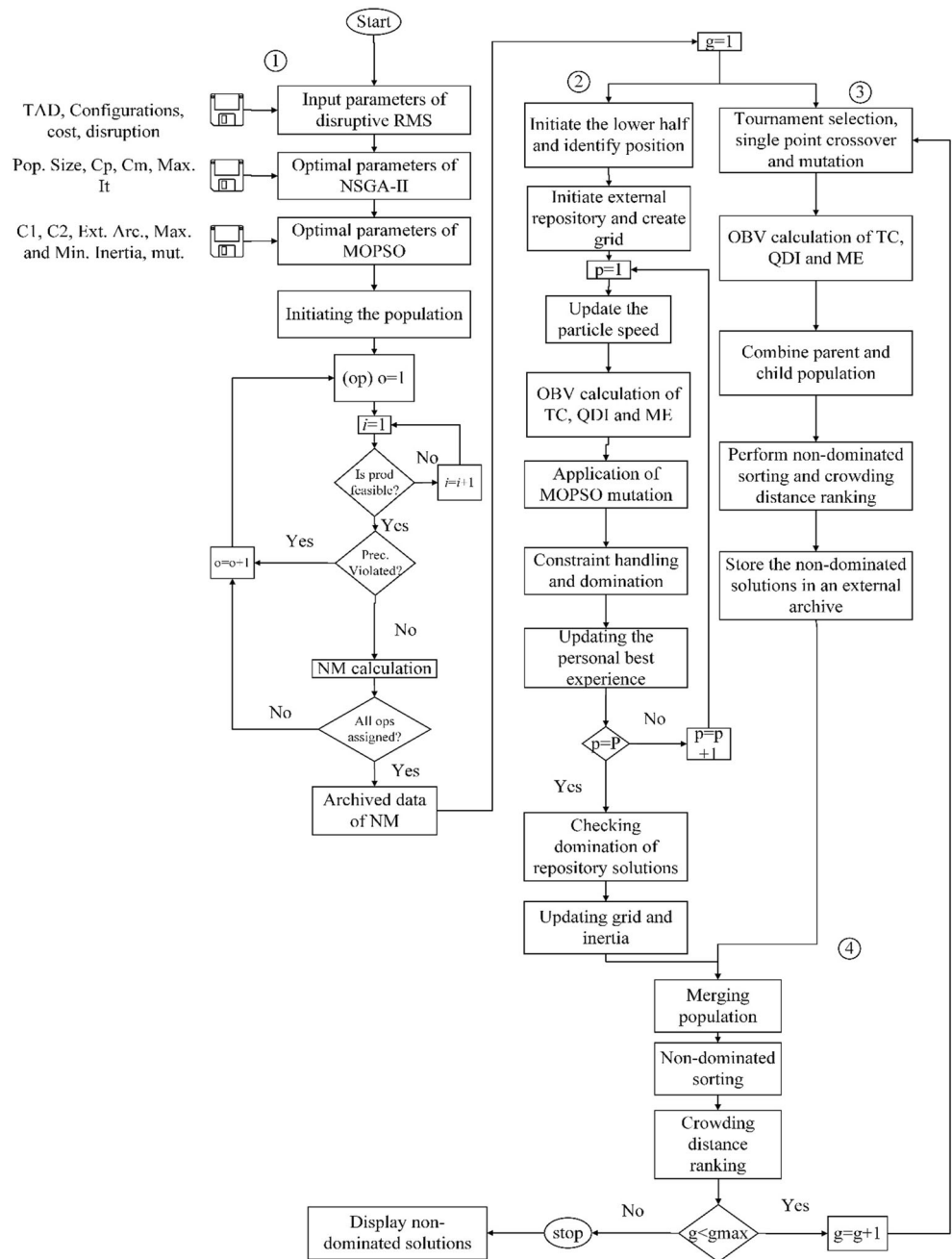

problems by using FI and BI termination criteria. A problem was defined by i_o (where i =machine configuration and o =operation). The respective results are provided in Figs 4, 5,

6, and 7. It can be observed that ϵ -constraint offers better results for small-sized problems; however, its solutions are less in number compared to other approaches. As the problem

Table 3 Example of matrix used for encoding scheme

Machine	M ₁	M ₃	M ₂	M ₁	M ₃	M ₃	M ₂	M ₁	M ₁
Module	A ₁₁ , A ₁₅	A ₃₁	A ₄₃	A ₁₆ , A ₁₂	A ₃₂	A ₃₄	A ₂₁	A ₁₃	A ₁₃ , A ₁₆
Feature	F ₁	F ₁	F ₂	F ₃	F ₂	F ₁	F ₁	F ₃	F ₂
Operation	O ₁	O ₂	O ₉	O ₁₄	O ₁₀	O ₄	O ₃	O ₁₆	O ₁₂
Quality characteristic	k ₃	k ₂	k ₅	k ₁	k ₆	k ₄	k ₈	k ₇	k ₉

Fig. 4 Non-dominated solutions of small-sized problems using FI (model 1)

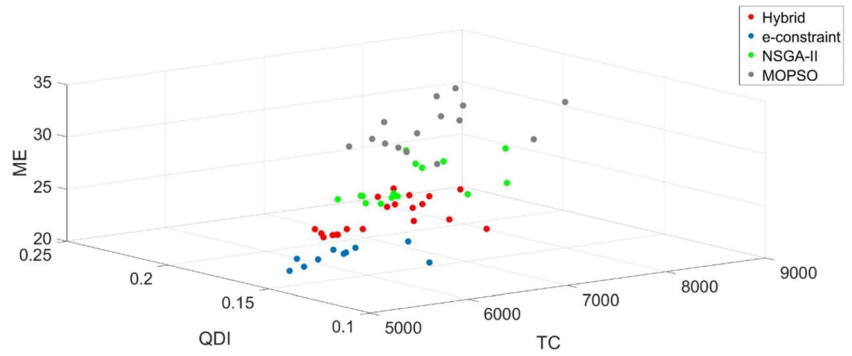

size gets bigger, ε -constraint does not provide feasible results (Figs. 6 and 7). Hybrid NSGA-II-MOPSO performs well compared to NSGA-II and MOPSO, and it has the highest number of non-dominated solutions. In other words, the solutions offered by hybrid heuristic are part of the non-dominated solutions. Moreover, as TC, QDI, and ME objectives are to be minimized, a solution closer to the origin (intersection of TC, QDI, and ME) will be preferred. From Figs. 4, 5, 6, and 7, among the meta-heuristics, the solutions offered by hybrid approach are closer to the origin. Similarly, the solutions of hybrid approach are uniformly distributed as compared to other approaches. The reason behind this improved performance of hybrid NSGA-II-MOPSO is due to the (i) division of population and (ii) merger of external archive of NSGA-II with the repository of MOPSO. Once the population is divided between NSGA-II and MOPSO, it becomes easier to refine the solutions to obtain a higher number of Pareto (non-dominated) solutions. In addition, the merger of external archive of NSGA-II with the repository of MOPSO helps in avoiding a pre-mature convergence.

Though ε -constraint offers feasible solutions for some problems, it is not viable as it takes a higher computation time. As an illustration, Fig. 8 provides the computation time (CPU) of solution approaches against different sizes of problems. It can be observed that as the problem size increases, CPU of ε -constraint increases non-linearly. On the other hand, HYB (FI) (hybrid with first improvement) performs better, and it takes less time in returning the results. Further, FI of a particular approach works well

compared to BI in terms of computation. It is because BI is a more exhaustive termination criteria which searches for the best solution and hence takes more time in offering Pareto optimal solutions.

From Figs. 4, 5, 6, and 7, MOPSO performs non-satisfactorily compared to other solution approaches. The reasons behind its non-satisfactory performance are twofold. Firstly, the repository of MOPSO is pre-defined with a fixed limit. If the number of solutions exceeds the limit, the repository discards some of the existing solutions which can affect the quality of returned solutions. Secondly, its non-satisfactory performance can be due to an inappropriate selection of mutation operator. Particle swarm optimization uses mutation to perform exploitation on portion of the population. The selection of mutation operator is pertinent as it can impact the population and convergence of solutions. As an illustration, different mutation values were selected to understand their impact on the solutions. Figure 9 provides the respective results of percentage convergence of different problem sizes against three mutation values. It can be observed that mutation impacts the convergence of solutions; however, an improved convergence can be ensured by selecting a higher rate of mutation. Further, mutation affects the population up to certain number of iterations. As shown, mutation rates of 0.4, 0.5, and 0.6 affect the population up until 45, 80, and 140 iterations, respectively, and stability in solutions is attained afterward. Thus, a higher rate of mutation is advantageous in obtaining higher convergence, and a lower rate of mutation is beneficial for minimum impact on population.

Fig. 5 Non-dominated solutions of small-sized problems using BI (model 1)

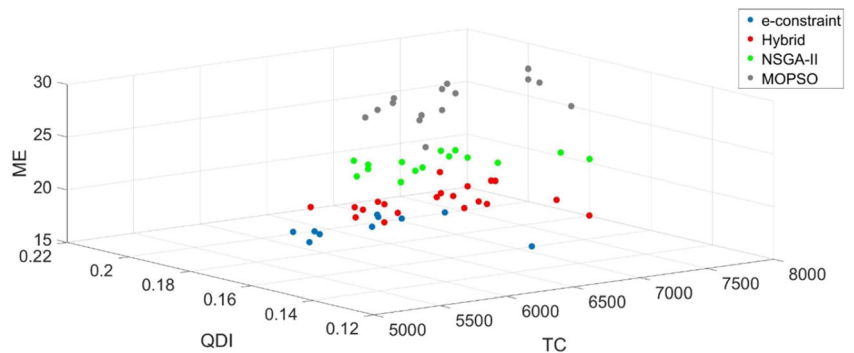
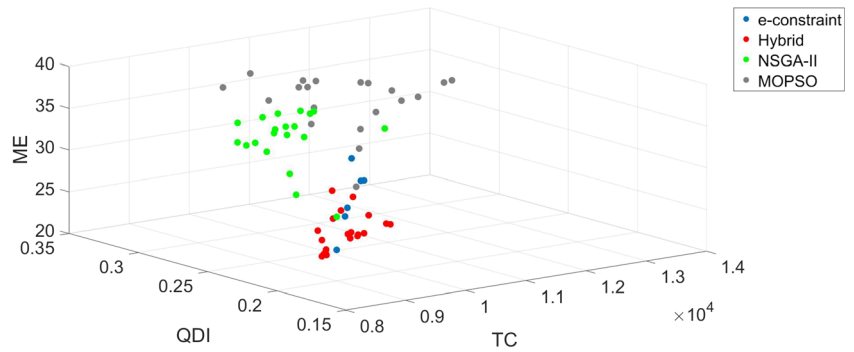

Fig. 6 Non-dominated solutions of large-sized problems using FI (model 1)



The results of small and large sets of problems by using the termination criteria of FI and BI are provided in Figs. 10 and 11, respectively. It can be observed that hybrid NSGA-II-MOPSO has the standout scores of IGD and HV for both small and large sets of problems. Further, all solution approaches perform well under the BI termination criteria, and MOPSO performs non-satisfactorily compared to other approaches. These findings reinforce the earlier presented analysis. It can be concluded that the hybrid approach ensures higher convergence as well as diversity of solutions and hybrid NSGA-II-MOPSO (BI) is the best solution approach; however, it takes more time in returning solutions. Due to its higher efficiency, the case study analysis is presented by using hybrid approach with BI criteria.

6.2 Model validation

The mathematical model can be applied to many industrial parts if the features and operational details of such parts are available. The proposed solution approaches are powerful enough to solve complex real-life problems. For instance, process planning can be carried out for the cylinder head [50], reconfigurable integrated manufacturing systems and reconfigurable assembly systems [4], real industrial parts [51], and products with complex features [40] by using the proposed approaches.

Without the loss of generality, a case study was used for implementing the models. The detailed part and precedence order of the case study are provided in Figs. 12 and 13,

respectively. The product needs the completion of 17 operations by using thirteen candidate machine configurations. The data related to TADs, modules, processing time, and cost of operations is given in Table 4. The data of tool approach directions (TADs), modules, and exploitation cost of machine configurations is provided in Table 5. Table 6 provides the addition, subtraction, and re-adjustment time of different modules. The production feasibility and production rate of machine configurations for different operations are provided in Table 7. A value in the corresponding cell means that a configuration is eligible to perform the associated operation. For example, machine configuration 1 can perform operation 2 with the production rate of 45 units/machine. The matrix of reconfiguration cost between different machine configurations is provided in Table 8. The production is to be carried out for a product demand of 250 units. The analysis was performed by using MATLAB 2016a on a system with specifications Intel Core i5, 8th generation with 8 GB RAM.

The top 17 non-dominated solutions of both models are provided in Table 9. Model 1 gives a minimum cost value of 9904 USD (s#15) compared to model 2 which has a minimum cost value of 8235 USD (s#15). Similarly, ME has a minimum value of 23.85 (s#7) and 19.03 (s#3) for model 1 and model 2, respectively. If we compare the values of TC (model 1) and TC (model 2), it can be concluded that all TC values of model 2 are less than the minimum TC value of model 1 (9904 USD). On the other hand, the average ME value of all solutions of model 1 is 33.25, and it is 25.79 for all solutions of model 2. Thus, on average, 22% less modularity effort is

Fig. 7 Non-dominated solutions of large-sized problems using BI (model 1)

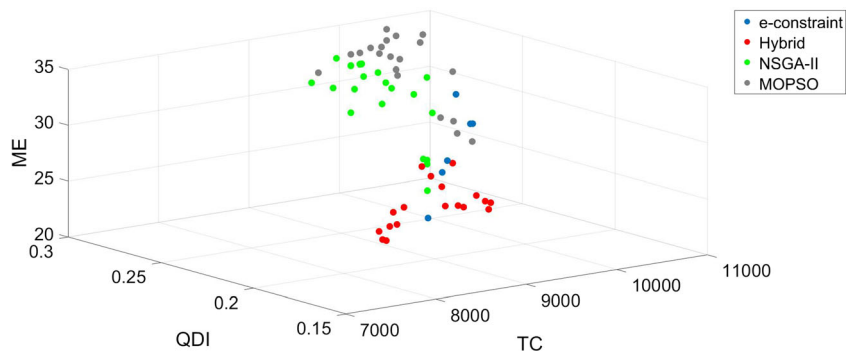
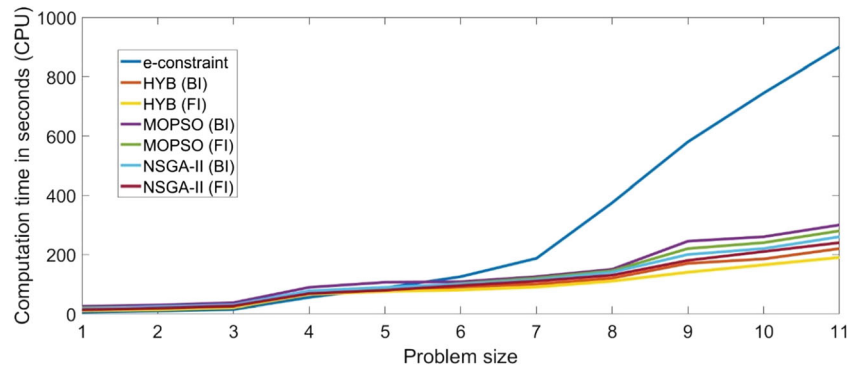

Fig. 8 CPU time of solution approaches against different problem sizes



needed in model 2. It means that if practitioner selects a random solution of model 2, it will have less cost than the minimum TC-based solution of model 1 and will need less average modular effort in completing the process plan. This highlights the role of quality variations in selecting a minimum cost and minimum modularity effort-based process plan.

It can be argued that the higher cost and modularity effort values of model 1 are due to the quality disruptions and failed operations. Due to it, modular effort has been invested in some operations which are discarded due to poor quality. The quality decay index (QDI) has a minimum value of 0.1511 (s#11) which means that the process plan has almost 15% failed operations compared to conforming operations. Since quality is only analyzed through model 1, we can see that the minimum solutions of TC, QDI, and ME contain 23.71%, 15.11%, and 22.65% failed operation units which corresponds to 60, 38, and 57 units of failed products, respectively. There is a trade-off involved in selecting a particular process plan. Some plans can offer less cost with higher quality decay index and modular effort and vice versa. For example, in some cases, as QDI value increases, the corresponding ME value increases as well. It means that (i) variation in quality necessitates a higher modular effort to complete the required level of conforming operations and (ii) higher QDI value means more failed operations and hence an increase in the lost modularity effort.

The detailed process plans against different objective functions are provided in Table 10. They can be interpreted column by column. For example, operation 1 (O_1) can be

performed by the 11th configuration for a minimum value of TC (M1), QDI (M1), and TC (M2). Similarly, we can use the 8th and 2nd configuration for operation 1 (O_1) to attain a minimum value of modular effort in model 1 and model 2, respectively.

The cost breakdown of minimum cost solutions of both models is presented in Fig. 14. Both models have the same reconfiguration cost (RC) as they provide minimum cost solution against the same process plan (s#15). Similarly, model 1 includes the values of scrap and re-work costs due to different defects and failed operations. The TMC value of model 1 is higher as it uses a higher number of machine configurations in the presence of variation in quality (Eq. 21).

A detailed analysis of modularity is presented in Fig. 15. These values are based on different components of ME (Eqs. 15 and 16). The total cost solution of model 1 uses higher addition, subtraction, and re-adjustment of modules as compared to the total cost solution of model 2. The same is true for the comparison of modules in the objective function of ME of both models. RMS is known for its cost-efficiency which can be achieved by performing more operations using less changes between configurations. This can be ensured if there are no quality-related problems and if less modular effort is needed. For example, in Fig. 15, we can see that the minimum number of configuration changes occur when a minimum ME solution of model 2 is used (144 configuration changes). Besides this, the solutions of model 1 relatively undergo a higher number of configuration changes. If we compare the number of machine

Fig. 9 The effect of mutation rate on convergence and population

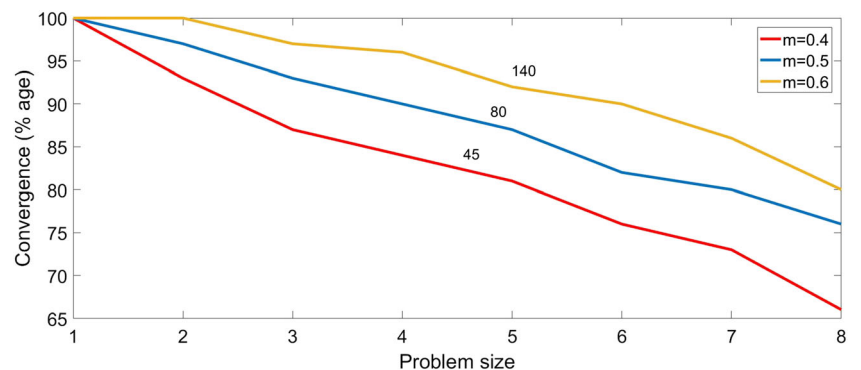

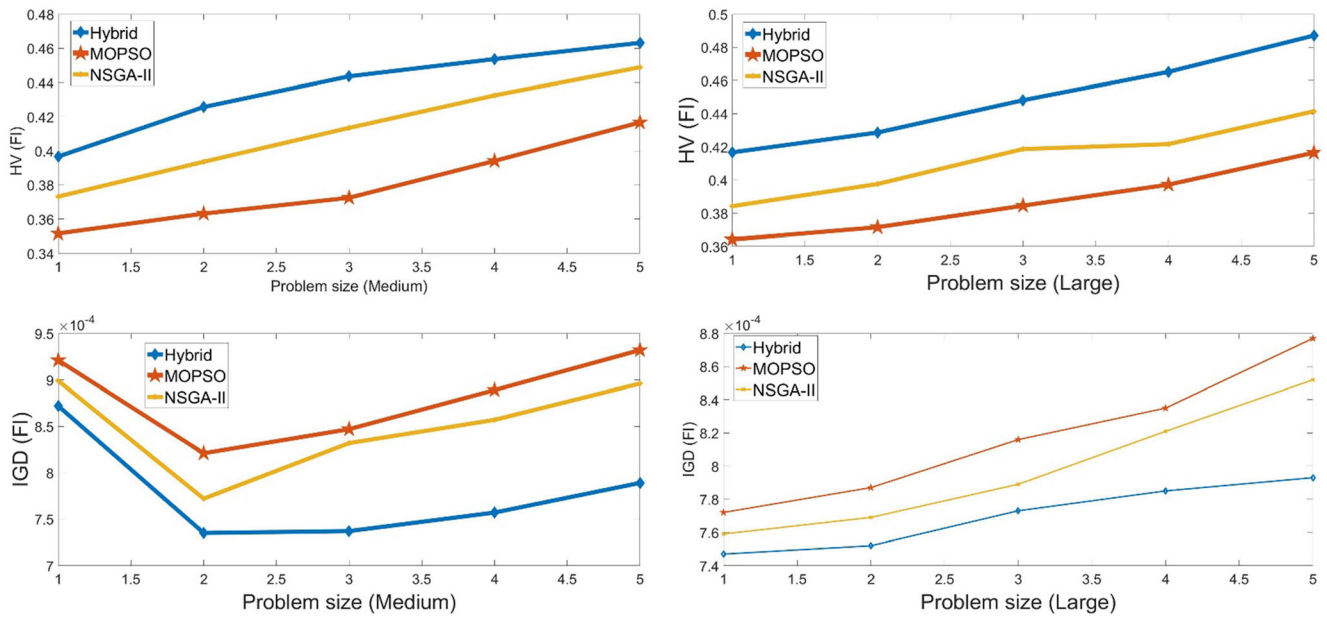

Fig. 10 HV and IGD scores of small- and large-sized problems using FI termination

configurations used by minimum ME solutions of model 1 and model 2, interestingly, both solutions use the same number of configurations (i.e., 36). However, minimum ME(M1)-based process plan has a value of 23.85 which is higher than the minimum ME(M2)-based process plan value of 19.03. The reasons behind using the same number of configurations and a higher difference of modularity effort values are two-fold. Firstly, from Table 10, we can see that ME(M2) process plan uses configurations more repetitively as compared to ME(M1) solution (e.g., it uses configuration 10 five times) which results in relatively less need for modular reconfiguration. This is reflected by the different sets of modules (added,

subtracted, re-adjusted) used in ME(M1) (361, 253, 90) and ME(M2) (163, 218, 37). Secondly, ME(M1) is based on quality issues, and hence it contains an extra proportion of lost modular effort due to failed and scrapped operations. Thus, quality aspects are not only important from cost and number of failed operations viewpoints, but they also impact the modularity of reconfigurable manufacturing system.

These findings can be generalized to multiple contexts. Practitioners need to know at the outset the number and types of modules they will be using for production. In the presence of variations and defects, the comparative analysis provides the details of extra modules and their dynamics (addition,

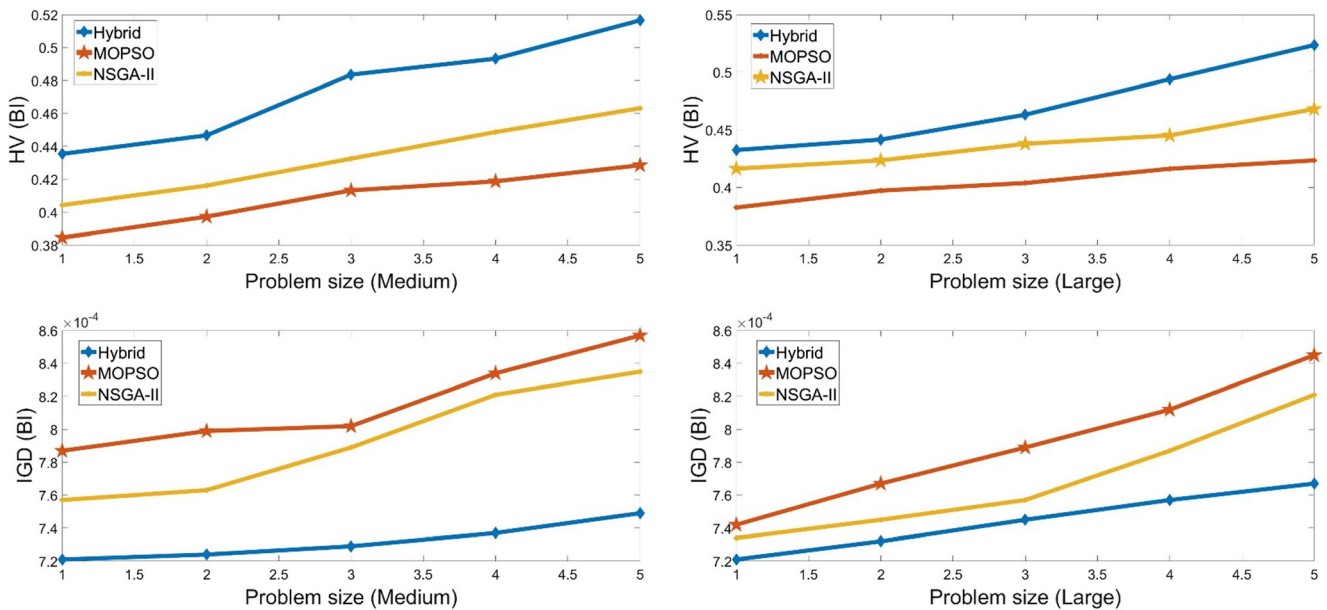

Fig. 11 HV and IGD scores of small- and large-sized problems using BI termination

Table 4 Operations, TADs, modules, operation time, and cost associated with different product features

Feature	Operations	TADs	Modules	t_f^o (min)	f_t (min)	pc_o (USD)
F ₁	O ₁	+x, -z	A ₁₁ , A ₁₃ , A ₃₁ , A ₃₂	3.5	39.5	07
	O ₂	+y	A ₂₂ , A ₃₄	05		10
	O ₃	-y, +z	A ₁₁ , A ₂₁ , A ₂₂ , A ₂₄	07		11
	O ₄	-x, -y, -z	A ₁₂ , A ₁₆	12		15
	O ₅	+y, -z	A ₁₄ , A ₁₆	04		06
	O ₆	-y	A ₁₅ , A ₂₃ , A ₃₃	08		10
	O ₇	-y, +z	A ₁₂ , A ₂₁ , A ₃₁	04		09
F ₂	O ₈	+x, +z	A ₁₆ , A ₂₅ , A ₃₄	4.5	35.5	07
	O ₉	-y, -z	A ₁₄ , A ₂₄	03		09
	O ₁₀	-y, +z	A ₁₅ , A ₂₂ , A ₃₂	05		10
	O ₁₁	-y	A ₁₁ , A ₁₃ , A ₂₅ , A ₃₂ , A ₃₃	10		12
	O ₁₂	-y, -z	A ₂₃ , A ₃₃ , A ₃₄	13		18
F ₃	O ₁₃	+x	A ₁₆ , A ₂₃ , A ₃₁	3.5	25.5	07
	O ₁₄	-y, -z	A ₁₃ , A ₂₄ , A ₃₂	04		06
	O ₁₅	-y	A ₁₅ , A ₁₆ , A ₂₁	05		09
	O ₁₆	-y, -z	A ₁₂ , A ₃₁ , A ₃₄	09		12
	O ₁₇	-x, +z	A ₂₁ , A ₃₃	04		08

subtraction, and re-adjustment) due to such defects. These findings will help in calculating the number of modules added, subtracted, and re-adjusted in the presence and absence of defects and quality variations. In addition, productivity can be enhanced (or production time can be minimized) by reducing the number of “reconfigurations” between different processes. A smaller number of reconfigurations is achieved in the case of minimum modularity effort solution in the absence of quality variations (ME (M2)). Thus, more focus should be given to simultaneously control the quality variations and minimize the modularity efforts to enhance the productivity of a reconfigurable manufacturing system. Lastly, the impact of multiple sources of quality variations was studied on the

cost, quality, and modularity performance of a reconfigurable manufacturing system. These findings can be compared with the real-time behavior of such sources of quality variations and defects. The real-time behavior of different defects can be analyzed by using a reconfigurable integrated manufacturing system (RIMS). RIMS can inspect and detect different sources of defects. Thus, the robustness of presented approaches and the accuracy of RIMS can be validated by comparing their respective findings.

The findings can be summarized as:

- Although RMS is known for its cost-efficiency, it seems that the variation in quality and failed operation units

Table 5 TADs, modules, and exploitation cost of different machine configurations

Machine	Configuration	TADs	Modules	ec_i
M1	1	+x, +y, -y, +z, -z	A ₁₁ , A ₁₄	350
	2	+x, -x, +y, -y, +z, -z	A ₁₂ , A ₁₄ , A ₁₆	380
	3	+x, -y, +z, -z	A ₁₁ , A ₁₃ , A ₁₅	440
	4	+x, -y, +z, -z	A ₁₃ , A ₁₅	330
	5	+x, -x, +y, -y, +z, -z	A ₁₂ , A ₁₄ , A ₁₅ , A ₁₆	475
M2	6	+x, -x, -y, +z, -z	A ₂₃ , A ₂₄ , A ₂₅	420
	7	-x, +y, -y, +z, -z	A ₂₁ , A ₂₂ , A ₂₄ , A ₂₅	580
	8	+x, -x, +y, -y, +z, -z	A ₂₂ , A ₂₃ , A ₂₅	450
	9	-x, -y, +z, -z	A ₂₁ , A ₂₄	350
M3	10	+x, -x, -y, +z, -z	A ₃₂ , A ₃₃	365
	11	+x, +y, -y, +z, -z	A ₃₁ , A ₃₂ , A ₃₄	410
	12	+x, -x, +y, -y, +z, -z	A ₃₃ , A ₃₄	380
	13	+x, -x, -y, +z, -z	A ₃₁ , A ₃₃	350

Table 6 Module addition, subtraction, and re-adjustment time for different auxiliary modules

Module	Associated time (min)		
	Addition	Subtraction	Re-adjustment
A ₁₁	2.7	2.3	1.5
A ₁₂	3	2.5	2.0
A ₁₃	2.5	2.0	1.5
A ₁₄	5	4.5	2.5
A ₁₅	4	3.0	2.0
A ₁₆	5	4.0	3.0
A ₂₁	4.2	3.5	2.5
A ₂₂	3.5	2.8	1.8
A ₂₃	5	4.0	2.5
A ₂₄	3	2.0	1.4
A ₂₅	4.5	2.0	1.1
A ₃₁	2.8	2.4	2.0
A ₃₂	4.2	2.5	1.5
A ₃₃	5.2	3.8	3.0
A ₃₄	5.5	4.0	2.6

impact the performance of RMS. Thus, it is imperative to safeguard it against different sources of variation to perform cost-optimally.

- There is a trade-off among cost, quality, and modularity. A process plan based on minimum quality variation affects the solutions of cost and modularity.
- The presence of quality variation results in a different process plan (model 1) as opposed to a manufacturing

Table 8 Configuration change cost between different machine configurations

Conf.	Configurations												
	1	2	3	4	5	6	7	8	9	10	11	12	13
1		185	165	150	190								
2			145	170	140								
3				175	180								
4					130								
5													
6						155	175	140					
7							150	180					
8								160					
9													
10										145	180	165	
11											165	190	
12												155	
13													

system which does not contain any quality variation (model 2). Both models performed quite differently in terms of modular needs and number of configurations.

- The presence of quality variation affects the overall efficiency of a process plan. It can be argued that in the absence of variation, even maximum cost solution is more viable than the minimum cost solution in the presence of variation. In addition, less average modular effort is needed by a process plan which is free from defects and variation. More modular efforts are needed by a process plan where there are higher quality concerns. This highlights

Table 7 Feasibility and production rate of configurations for different operations

Conf.	Operation																
	O ₁	O ₂	O ₃	O ₄	O ₅	O ₆	O ₇	O ₈	O ₉	O ₁₀	O ₁₁	O ₁₂	O ₁₃	O ₁₄	O ₁₅	O ₁₆	O ₁₇
1	--	45	--	75	55	70	--	--	50	--	45	--	45	40	--	--	60
2	75	55	--	--	--	60	--	60	--	--	65	45	--	--	55	--	--
3	--	--	60	60	--	--	55	--	60	65	--	55	60	--	60	45	--
4	65	--	80	--	65	--	50	--	70	--	60	--	--	55	--	--	65
5	--	50	67	65	--	70	--	55	--	--	75	--	55	--	70	45	--
6	60	--	--	55	60	55	65	--	75	70	--	48	--	65	--	55	55
7	--	60	60	--	70	--	65	--	60	--	65	--	45	60	--	65	--
8	55	--	70	--	--	75	--	50	--	55	60	--	50	--	45	--	45
9	--	45	--	70	--	65	--	70	55	--	--	53	--	70	75	60	--
10	--	55	50	--	65	--	70	--	60	50	50	--	60	--	--	--	--
11	60	--	55	75	--	60	--	65	--	70	--	45	--	55	--	--	50
12	--	50	--	--	60	--	65	55	--	--	63	--	65	--	65	70	--
13	70	--	75	--	--	50	--	--	77	--	--	--	60	--	60	--	60

Fig. 12 Product features of the case study and their operations

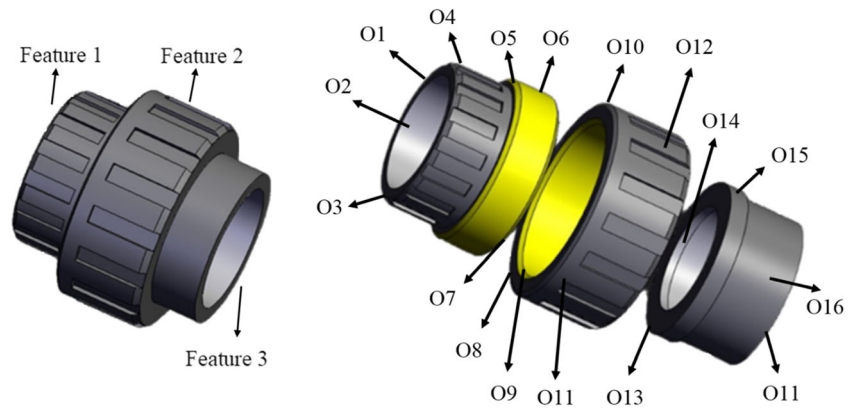

the role of quality variation in the selection of a process plan based on minimum cost and minimum modular effort.

- Practitioners are interested in enhancing the productivity of RMS by minimizing the “reconfiguration” between different operations. The findings suggest that modular efforts and quality variation need to be simultaneously analyzed to enhance the overall productivity and efficiency of a process plan.
- As variation and defects are inevitable in a real manufacturing setup, it is opportune to know the extra modular efforts needed due to such variation. This will enable a practitioner to decide at the outset the number of extra modules added/subtracted/re-adjusted in the presence of variation. The findings of this paper are applicable to any real-life RMS system to calculate the extra modular needs in the presence of variation and defects.
- The proposed model and solution approaches are general, and they can be applied to multiple real-life RMS systems. For this, the acyclic graph and operational details of the considered products will be required.
- The hybrid meta-heuristic approach was efficient compared to the stand-alone application of meta-heuristics. It resulted in uniformly distributed and dominant solutions due to the merger of solution storage capacities of both meta-heuristics. Further, the best improvement criterion

works well; however, it takes more time in returning the solutions.

- The impact of multiple sources of variation was mathematically studied on the overall cost, quality, and modularity efficiency of process planning. The robustness of presented approaches and the accuracy of RIMS can be validated by comparing their respective findings.

7 Conclusion and future recommendations

Reconfigurable manufacturing system has received an overwhelming amount of research attention due to its high throughput, responsiveness, and cost optimal production. This study analyzed the impact of quality variations on the performance of process planning in reconfigurable manufacturing system. A multi-objective model containing

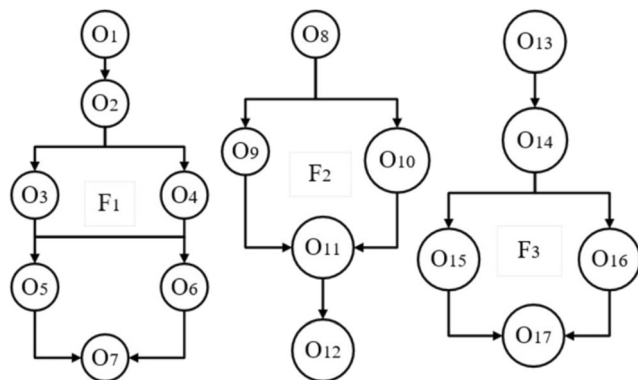

Fig. 13 Operation precedence of different product features

Table 9 The non-dominated solutions of model 1 and model 2

S. no	Model 1			Model 2	
	TC	QDI	ME	TC	ME
1	11300	0.2196	34.71	8804	24.22
2	10435	0.2235	30.51	8566	25.69
3	10362	0.2465	24.39	8989	19.03
4	11402	0.1799	24.39	8963	19.84
5	10402	0.2019	47.53	8555	25.83
6	10403	0.1843	34.92	8528	26.15
7	10531	0.2265	23.85	8824	19.94
8	10407	0.1776	40.61	8407	36.22
9	10470	0.1841	36.34	8514	31.54
10	11012	0.1705	35.48	8818	24.12
11	10530	0.1511	38.34	8525	26.19
12	11540	0.1797	29.49	8598	24.88
13	10414	0.2035	34.87	8572	25.43
14	11059	0.2229	34.82	8802	24.28
15	9904	0.2371	29.12	8235	36.24
16	10923	0.2234	31.08	8742	24.86
17	10818	0.2031	34.86	8819	24.08
Sum			565.31		438.54
Average value			33.25		25.79

Bold values refer to the optimal objective function values

Table 10 Detailed process plans of optimal objective functions-based solutions

S.#		O ₁	O ₂	O ₃	O ₄	O ₅	O ₆	O ₇	O ₈	O ₉	O ₁₀	O ₁₁	O ₁₂	O ₁₃	O ₁₄	O ₁₅	O ₁₆	O ₁₇
15	TC (M1)	11	7	5	9	1	9	4	8	4	10	2	6	10	6	9	12	11
11	QDI (M1)	11	1	5	9	10	13	10	2	6	6	12	6	8	11	5	5	11
7	ME (M1)	8	10	7	3	7	2	3	11	13	6	7	3	5	7	5	12	11
15	TC (M2)	11	7	5	9	1	9	4	8	4	10	2	6	10	6	9	12	11
3	ME (M2)	2	1	10	1	10	2	10	11	10	3	10	11	12	9	8	7	11

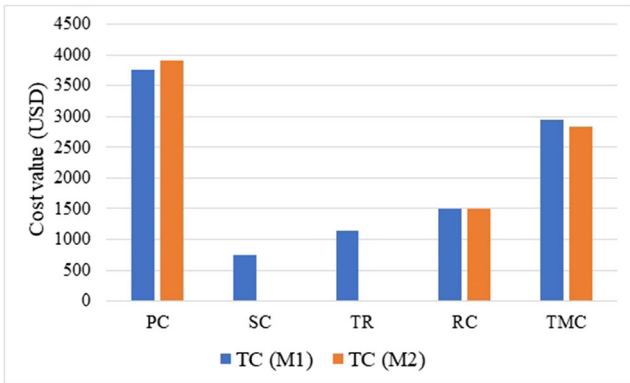

Fig. 14 Cost breakdown of model 1 and model 2

the objectives of total cost, quality decay index, and modular effort was presented. A novel hybrid version of two powerful meta-heuristics (i.e., non-sorting genetic algorithm and multi-objective particle swarm optimization) was implemented to obtain solutions. A set of experiments revealed that the hybrid solution approach is more efficient. The hybrid heuristic takes advantage of dividing the population and merging storage capacities which enhances the number of non-dominated solutions and mitigates a pre-mature convergence. The findings

suggested to control quality variations and defects as it impacts different aspects of decision-making. Moreover, there is a trade-off among cost, quality, and modularity. It is important to reduce the quality variations, defects, and modularity efforts for a cost-optimal reconfigurable system.

This study offers the following implications for practitioners. The manufacturing system design decomposition (MSDD) divides a complex system into different levels to identify the prominent causes of quality variation. These causes can be modeled to examine their impact on the cost and modularity aspects of a complex reconfigurable system. Practitioners may install a reconfigurable integrated manufacturing system (RIMS) to study the real-time behavior of such causes of variations. In addition, with and without quality variation results can be used to focus on minimizing the additional cost components and lost modularity efforts due to quality issues. These findings will help in calculating the extra number of added, subtracted, and re-adjusted modules in the presence of quality variations. Though the mathematical model and solution approaches were applied to a single product, they can be generalized to multi-unit complex reconfigurable process planning.

Fig. 15 Comparison of modular features of different models

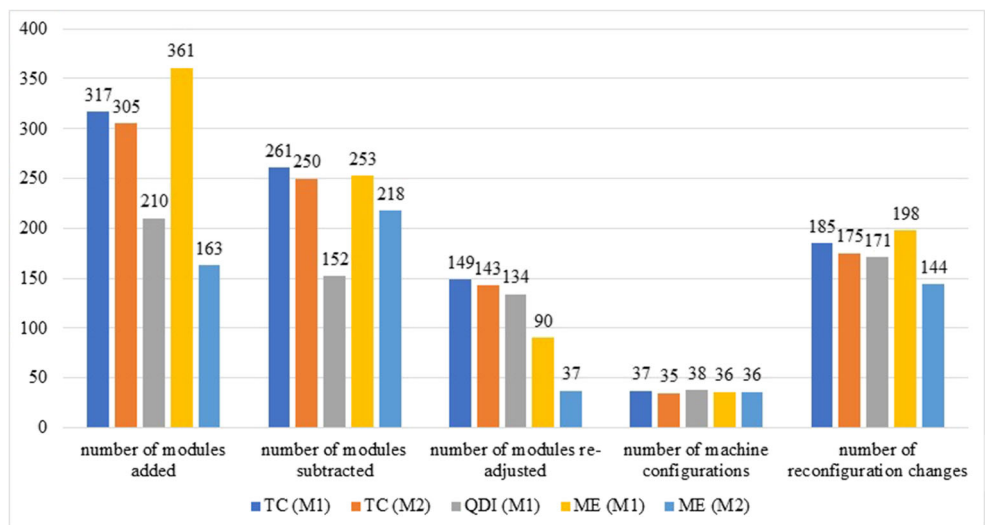

The following can be considered as recommendations for future research. In the implemented e-constraint approach, the loop is completed when the epsilon values related to either QDI or ME cannot be reduced anymore. This was done by using an “and” operator between both epsilons. Future research can use an “or” operator so that the epsilon values of both constraints can be saturated. This might result in improved solutions for a different set of problems. A deterministic model with respect to production capacities, disruption, and failure rates was used. Future research can relax this assumption by considering stochastic parameters in the model. These stochastic parameters can be associated with the disruption profile, failure rates due to different variations, etc. A pessimistic approach for the evaluation of different defects was considered. This assumption can be modified by considering the interaction between different defects at the level of machine, process, and tool. The presented analysis focused on the causes of variations during production. The pre-production cause of variation, i.e., deficiency in the quality of raw materials, can be modeled in the future research. In this way, process planning can be carried out in the context of supply chain by analyzing the quality of raw materials and supplier evaluation. Lastly, these findings can be compared with other evolutionary approaches such as whale optimization algorithm (WOA) and strength Pareto evolutionary algorithm (SPEA).

Author contribution Conceptualization: Abdul Salam Khan and Ali Siadat. Modeling: Abdul Salam Khan and Jean Yves Dantan. Methodology and analysis: Abdul Salam Khan. Validation: Lazhar Homri. Writing: Abdul Salam Khan. Proof-reading and corrections: Ali Siadat and Lazhar Homri.

Funding This research was funded by the Higher Education Commission (HEC) Pakistan and Campus France under the scholarship number 904180K.

Data Availability Data can be made available for future researchers and aspirants, upon request.

Declarations

Ethics approval This study follows the ethical standards and the Committee on Publication Ethics (COPE) guidelines.

Consent to participate Not applicable

Consent for publication Not applicable

Competing interests The authors declare no competing interests.

References

- Koren Y, Heisel U, Jovane F, Moriwaki T, Pritschow G, Ulsoy G, Van Brussel H (1999) Reconfigurable manufacturing systems. *Ann CIRP* 48:2
- Taguchi G, Clausing D (1990) Robust quality. *Harv Bus Rev* 68(1): 65–75
- Elmaraghy WH, Nada OA, ElMaraghy HA (2008) Quality prediction for reconfigurable manufacturing systems via human error modelling. *Int J Comput Integr Manuf* 21(5):584–598
- Koren Y, Gu X, Guo W (2018a) Reconfigurable manufacturing systems: principles, design, and future trends. *Front Mech Eng* 13(2):121–136
- Koren Y, Gu X, Guo W (2018b) Choosing the system configuration for high-volume manufacturing. *Int J Prod Res* 56(1-2):476–490
- Whitney DE (2004) *Mechanical assemblies: their design, manufacture, and role in product development*. Oxford university press, New York
- Shaik AM, Rao VK, Rao CS (2015) Development of modular manufacturing systems—a review. *Int J Adv Manuf Technol* 76(5-8):789–802
- Stamatis DH (2003) *Failure mode and effect analysis: FMEA from theory to execution*. Quality Press
- Mahto D, Kumar A (2008) Application of root cause analysis in improvement of product quality and productivity. *J Indust Eng Manag (JIEM)* 1(2):16–53
- Zheng LY, Liu Q, McMahon CA (2010) Integration of process FMEA with product and process design based on key characteristics. In: *Proceedings of the 6th CIRP-sponsored international conference on digital enterprise technology*. Springer, Berlin, pp 1673–1686
- Srinivasan V (1999) On interpreting key characteristics. In *Proceeding of the 1999 ASME Design Engineering Technical Conferences* pp. 12-15
- Khorramshahgol R, Djavanshir GR (2008) The application of analytic hierarchy process to determine proportionality constant of the Taguchi quality loss function. *IEEE Trans Eng Manag* 55(2):340–348
- Loose JP, Zhou S, Ceglarek D (2008) Variation source identification in manufacturing processes based on relational measurements of key product characteristics. *J Manuf Sci Eng* 130(3)
- Schmitz B (1997) Practicing tolerance. *CAE* 16(9):12
- Thomton AC (1999) A mathematical framework for the key characteristic process. *Res Eng Des* 11(3):145–157
- Thomton AC (2000) Quantitative selection of variation reduction plans. *J Mech Des* 122(2):185–193
- Hsu LF, Tapiero CS (1989) Quality control of an unreliable flexible manufacturing system with scrapping and infinite buffer capacity. *Int J Flex Manuf Syst* 1(4):325–346
- Karsak EE, Kuzgunkaya O (2002) A fuzzy multiple objective programming approach for the selection of a flexible manufacturing system. *Int J Prod Econ* 79(2):101–111
- Li J, Huang N (2007) Quality evaluation in flexible manufacturing systems: a Markovian approach. *Math Probl Eng* 2007(1):24
- Souier M, Dahane M, Maliki F (2019) An NSGA-II-based multi-objective approach for real-time routing selection in a flexible manufacturing system under uncertainty and reliability constraints. *Int J Adv Manuf Technol* 100(9-12):2813–2829
- Mittal KK, Jain PK (2014) An overview of performance measures in reconfigurable manufacturing system. *Proc Eng* 69:1125–1129
- Cochran D, Rudolf H (2003) Investment and resource allocation methodology to support manufacturing system Design Implementation. *J Manuf Syst CIRP*
- Goyal KK, Jain PK, Jain M (2012) Optimal configuration selection for reconfigurable manufacturing system using NSGA II and TOPSIS. *Int J Prod Res* 50(15):4175–4191
- Moghaddam SK, Houshmand M, Saitou K, FatahiValilail O (2020) Configuration design of scalable reconfigurable manufacturing systems for part family. *Int J Prod Res* 58(10):2974–2996
- Touzout FA, Benyoucef L (2019) Multi-objective multi-unit process plan generation in a reconfigurable manufacturing

- environment: a comparative study of three hybrid metaheuristics. *Int J Prod Res* 57(24):7520–7535
26. Deif AM, ElMaraghy W (2007) Investigating optimal capacity scalability scheduling in a reconfigurable manufacturing system. *Int J Adv Manuf Technol* 32(5-6):557–562
 27. Dou J, Dai X, Meng Z (2011) A GA-based approach for optimizing single-part flow-line configurations of RMS. *J Intell Manuf* 22(2): 301–317
 28. Chaube A, Benyoucef L, Tiwari MK (2012) An adapted NSGA-2 algorithm based dynamic process plan generation for a reconfigurable manufacturing system. *J Intell Manuf* 23(4):1141–1155
 29. Saxena LK, Jain PK (2012) A model and optimisation approach for reconfigurable manufacturing system configuration design. *Int J Prod Res* 50(12):3359–3381
 30. Haddou Benderbal H, Dahane M, Benyoucef L (2017) Flexibility-based multi-objective approach for machines selection in reconfigurable manufacturing system (RMS) design under unavailability constraints. *Int J Prod Res* 55(20):6033–6051
 31. Touzout FA, Benyoucef L (2019a) Multi-objective sustainable process plan generation in a reconfigurable manufacturing environment: exact and adapted evolutionary approaches. *Int J Prod Res* 57(8):2531–2547
 32. Dou J, Su C, Zhao X (2020b) Mixed integer programming models for concurrent configuration design and scheduling in a reconfigurable manufacturing system. *Concurr Eng* 28(1):32–46
 33. Khezri A, Benderbal HH, Benyoucef L (2020) Towards a sustainable reconfigurable manufacturing system (SRMS): multi-objective based approaches for process plan generation problem. *Int J Prod Res* 1–26
 34. Taguchi G, Rafanelli AJ (1994) Taguchi on robust technology development: bringing quality engineering upstream
 35. Bensmaine A, Dahane M, Benyoucef L (2013) A non-dominated sorting genetic algorithm based approach for optimal machines selection in reconfigurable manufacturing environment. *Comput Ind Eng* 66(3):519–524
 36. Mohapatra P, Benyoucef L, Tiwari MK (2013) Integration of process planning and scheduling through adaptive setup planning: a multi-objective approach. *Int J Prod Res* 51(23-24):7190–7208
 37. Hasan F, Jain PK, Kumar D (2014) Optimum configuration selection in reconfigurable manufacturing system involving multiple part families. *Opsearch* 51(2):297–311
 38. Dahane M, Benyoucef L (2016) An adapted NSGA-II algorithm for a reconfigurable manufacturing system (RMS) design under machines reliability constraints. In *Metaheuristics for production systems* (pp. 109-130). Springer, Cham
 39. Ashraf M, Hasan F (2018) Configuration selection for a reconfigurable manufacturing flow line involving part production with operation constraints. *Int J Adv Manuf Technol* 98(5-8): 2137–2156
 40. Benderbal HH, Dahane M, Benyoucef L (2018) Modularity assessment in reconfigurable manufacturing system (RMS) design: an archived multi-objective simulated annealing-based approach. *Int J Adv Manuf Technol* 94(1-4):729–749
 41. Liu M, An L, Zhang J, Chu F, Chu C (2019) Energy-oriented bi-objective optimization for a multi-module reconfigurable manufacturing system. *Int J Prod Res* 57(19):5974–5995
 42. Pal Singh P, Madan J, Singh H (2020) Composite performance metric for product flow configuration selection of reconfigurable manufacturing system (RMS). *Int J Prod Res* 1–21
 43. Dou J, Li J, Xia D, Zhao X (2020a) A multi-objective particle swarm optimisation for integrated configuration design and scheduling in reconfigurable manufacturing system. *Int J Prod Res* 1–21
 44. Prasad D, Jayswal SC (2019) Assessment of a reconfigurable manufacturing system. *Benchmark Int J*
 45. Cochran DS, Jafri MU, Chu AK, Bi Z (2016) Incorporating design improvement with effective evaluation using the manufacturing system design decomposition (MSDD). *J Ind Inf Integr* 2:65–74
 46. Goyal KK, Jain PK (2016) Design of reconfigurable flow lines using MOPSO and maximum deviation theory. *Int J Adv Manuf Technol* 84(5-8):1587–1600
 47. Eberhart R, Kennedy J (1995) A new optimizer using particle swarm theory. In *MHS'95. Proceedings of the Sixth International Symposium on Micro Machine and Human Science* IEEE pp. 39-43
 48. Coello CA, Pulido GT, Lechuga MS (2004) Handling multiple objectives with particle swarm optimization. *IEEE Trans Evol Comput* 8(3):256–279
 49. Deb K (2001) *Multi-objective optimization using evolutionary algorithms*. John Wiley & Sons
 50. Wang W, Koren Y (2012) Scalability planning for reconfigurable manufacturing systems. *J Manuf Syst* 31(2):83–91
 51. Asghar E, uz Zaman UK, Baqai AA, Homri L (2018) Optimum machine capabilities for reconfigurable manufacturing systems. *Int J Adv Manuf Technol* 95(9):4397–4417