



### **Science Arts & Métiers (SAM)**

is an open access repository that collects the work of Arts et Métiers Institute of Technology researchers and makes it freely available over the web where possible.

This is an author-deposited version published in: <https://sam.ensam.eu>  
Handle ID: <http://hdl.handle.net/10985/6535>

#### **To cite this version :**

Stéphane LELEU, Patrick MARTIN, Cyrille BAUDOUIN, Regis BIGOT - Gear geometric control software : approach by entities - 2008

Any correspondence concerning this service should be sent to the repository

Administrator : [scienceouverte@ensam.eu](mailto:scienceouverte@ensam.eu)



---

# Gear geometric control software: approach by entities

C. Baudouin · R. Bigot · S. Leleu · P. Martin

**Abstract** For many years the transmission industry has had a major impact on the design of mechanical parts. In addition to geometric quality of the forging process, net-shaped bevel gears offer new ways to decrease costs and to increase mechanical properties. This paper deals with the difficulty in applying classical quality inspection to forged bevel gears. We developed a new approach based on entities and used it in an industrial context. One aspect of this method is that the gear teeth can be measured regardless of assembly surfaces.

**Keywords** Bevel gear · Geometric control · Precision manufacturing · Process capability · Integrated design

## 1 Introduction

For more than a century, power transmission has been a major technology in the automotive, mechanical, and aeronautic industries. Lot of works has been realized in gear quality inspection domain. They have expensive and time-consuming

effects [1]. Manufacturing engineers need information to help them to measure just index, helix, and the involute profile of a gear, according to ISO standards [2–8].

The introduction of numerically controlled gear measuring tools and coordinate measuring tools in the quality inspection process gives new ways to study gear functionalities [9].

For large quantity manufacturing, the cutting process is associated with casting and forging process. For 60 years the forging process has been largely improved, and now, complex parts can be formed precisely by closed-die forging. Moreover, this process brings a decrease of manufacturing cost, a considerable material savings, and an increase of mechanical properties. Then, net shape or near-net shape of cold-forged parts has been desired in actual manufacturing factories (Fig. 1). Various products having internal and external gears are studied. In this work, we explain the main issues concerning the analysis of product functionalities with quality inspection, according to ISO standards. We propose a new approach based on entities. This development is integrated in software for industrial application. At the end, we illustrate our work on the heat treatment process in a forging plant.

## 2 The control of gears according standard references

### 2.1 Context

Generally, for all mechanical parts, the functional tolerancing of gear teeth concerns the geometric specifications on features. The designer has to face the transcription of the guaranty of a product to fulfil a requirement, into geometric specifications. Then, the metrologist checks that the real geometry is in the volume determined. He also has to evaluate the geometric deviations from the nominal

---

C. Baudouin · R. Bigot (✉) · P. Martin  
Laboratoire de Génie Industriel et Production Mécanique  
(LGIPM-IFAB), EA 3096, Ecole Nationale Supérieure  
d'Arts et Métiers-C.E.R de Metz,  
4, rue Augustin Fresnel,  
57078 Metz Cedex3, France  
e-mail: regis.bigot@metz.ensam.fr

S. Leleu  
Laboratoire de métrologie et de mathématiques appliquées  
(L2MA), Ecole Nationale Supérieure d'Arts et Métiers,  
CER Lille-8, boulevard Louis XIV,  
59046 Lille Cedex, France

Fig. 1 Planet gear of an automotive differential

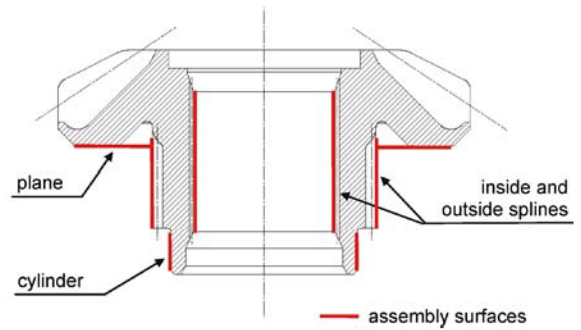

definition to transpose them into qualitative variations of the functionality. In an integrated design context, these data enable to act on process planning during the designing and the manufacturing process.

## 2.2 Definition

So for gears, in addition to the general geometric specifications (linear dimensions, diameter, orientations...), particular specifications are necessary, such as single pitch error, pitch variation, and tooth profile error. Some ISO standards traduce and define these parameters.

Specifically, we can define (Fig. 2):

- Pitch:** length of pitch circle between two corresponding flanks [5].
- Pitch diameter:** diameter of the pitch circle located at the intersection between pitch cone and back cone [5].
- Single pitch error:** algebraic difference between real and theoretic pitch calculated on a control circle [2]. The Standard ISO/TR 10064-1 recommends that control must be done approximately at semi-height and semi-width of gear teeth [3].

## 2.3 Model limits of net-shape gear inspection

Concerning a cylindrical gear, pitch diameter can be considered as the inspection circle, even if there is a small difference between both. Indeed, an intersection does exist between flanks and pitch diameter. Concerning bevel gears, this intersection does not really exist, unless over the limits of the part itself (Fig. 2). When inspecting a bevel gear, it is hard to get some information about this measurement. The ISO advises to inspect the gear by taking one point per flanks, located on the middle of this face and on the pitch cone.

The inspection setup was initially designed for a gear machined by cutting rack. If the defect evaluation in one point by flank is enough to make corrections on the cutting machine because involute are made by envelope, it is not enough to feature the real quality of the part functionality. Indeed, when evaluating pitch error on the control circle, the result is not representative because the active surface of a tooth is larger than a single point. From a functional point of view, it is necessary to evaluate base pitch on each angular position of the meshing.

Concerning *net-shaped* forged bevel gears, gear teeth are not generated with a same rack for all teeth, but by a forming process, thus each tooth is independent from the others. As the part is the replication of the forming die, one flank can be submitted to a local deformation coming for

Fig. 2 Definitions on bevel gear

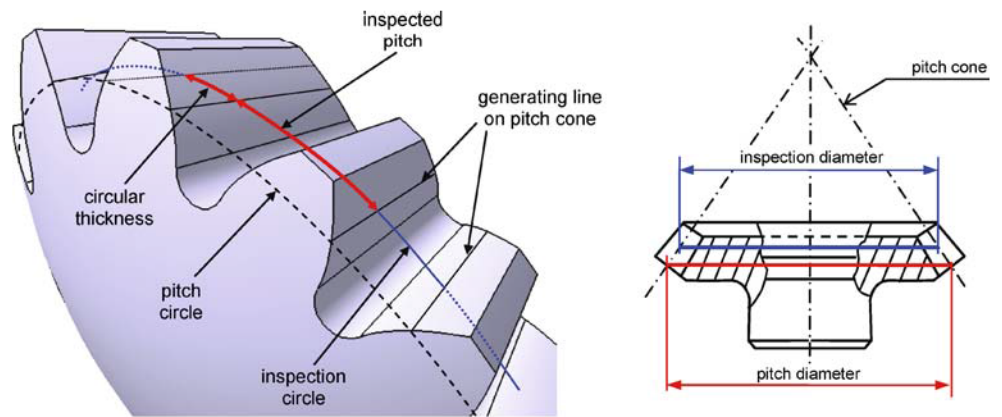



instance from the lubrication process or die manufacturing. Consequently, the inspection process using one point per flank can be affected by shape defect of the flank (Fig. 3). Then, the inspection process has to be redefined in order to include the functional aspect in the identification of flank deflects.

### 3 Approach by entities

#### 3.1 Conceptual model of entities

To check the functionality of a bevel gear, we have reconsidered the control of such parts, regardless of the manufacturing process. We have defined functional entities to build the model of the gear, particularly at a geometrical and metallurgical level. Our model is the result of a reflection from different points of view (designer, manufacturer, metallurgist, control...). So it is transversal, but is to evolve in order that significant data can be put or taken off easily from the different points of views.

Based on functional entities of gear teeth, the elementary entity can be built only on one surface type element (Fig. 4). Among all the characteristics of entities, the metrologist studies the geometric ones. The Macro entity "Gear" is defined by other Macro entities such as "Gear Teeth", "Material" and "Plane, Cylinder". Then, the Macro entity "Gear Teeth" is made of  $Z$  Macro entities "Tooth", where  $Z$  is the number of teeth. Each Macro entities "Tooth" is also made of entities such as "Left-Right Flank" and "Root-Tip surface". Then, as "Material" is the same for the whole gear, it is at the same level as "Gear". Thus this model can be used in all manufacturing process considering that "Gear Teeth" is defined regardless of "Plane, Cylinder". For example, the element "Right Flank" is the set of

points in the space closely connected, which define geometrically the active flank, but the entity "Right Flank" will be made of other characteristics such as profile error or lead error, interpreted and defined in relation with cinematic parameters. From the functional entities, we rebuilt the gear with macro-entities step by step. A macro-entity is an entity that can be split up into macro-entities or elementary entities. For each macro-entity, some other characteristics are added to switch from a surface to a volume or from a geometric volume to mechanic and cinematic characteristics. In this model, the different entities of the macro-entity "Gear" changes as the "State" characteristic changes. Before each step of the design-production-control process, everyone is able to extract useful data or do its calculus for instance. At each step of the manufacturing process, the participant will give the new information he gets and has to update the "State" data (initial geometry, calibrated, heat treated, etc.). Everyone can carry out their task as soon as useful data is available, then several steps could be lead in parallel.

Initial values needed by the metrologist to check gears are summed up in Table 1. We notice that the metrologist does not have to wait for the design drawings to do his task. As soon as the numeric definition is available, he can prepare the numeric programming of control on the Coordinate Measuring Machine before having the admissible variations. Once the controls are done, the metrologist gives the values of the different characteristics that defined the entities of the gear. The value of the characteristic "State" of the macro-entity "Gear" is modified as the operation of control is done. It becomes, for example, "calibrated and geometrically controlled" or "calibrated, geometrically controlled and mechanical resistance checked".

#### 3.2 Operations with entities

In accordance with the Geospelling model, the operations on the entities are based on the distinction between the ideal and non-ideal geometric elements as well as the existence of six types of operations [10, 11].

Let us consider a real gear (non-ideal element). The operation of *Partition* splits up the whole real gear into elementary geometric elements. On each element, the operation of *Extraction* gives a discretized representation of the surface. In other words, the surface of the considered element is not defined any more by an infinite set of points but by a finished set of points. This discrete image of the real gear can be measured using a Coordinate Measuring Machine. By a theoretical and practical estimation, we previously proved that the level of uncertainty of Coordinate Measuring Machines was largely lower than the requirements of precision of the forged bevel gears for automotive differential.

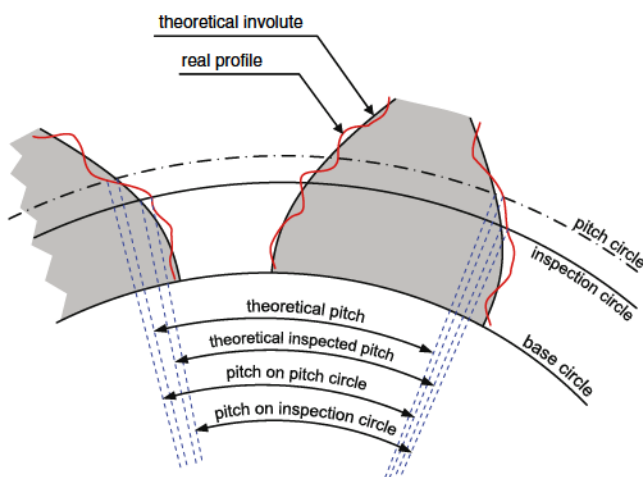
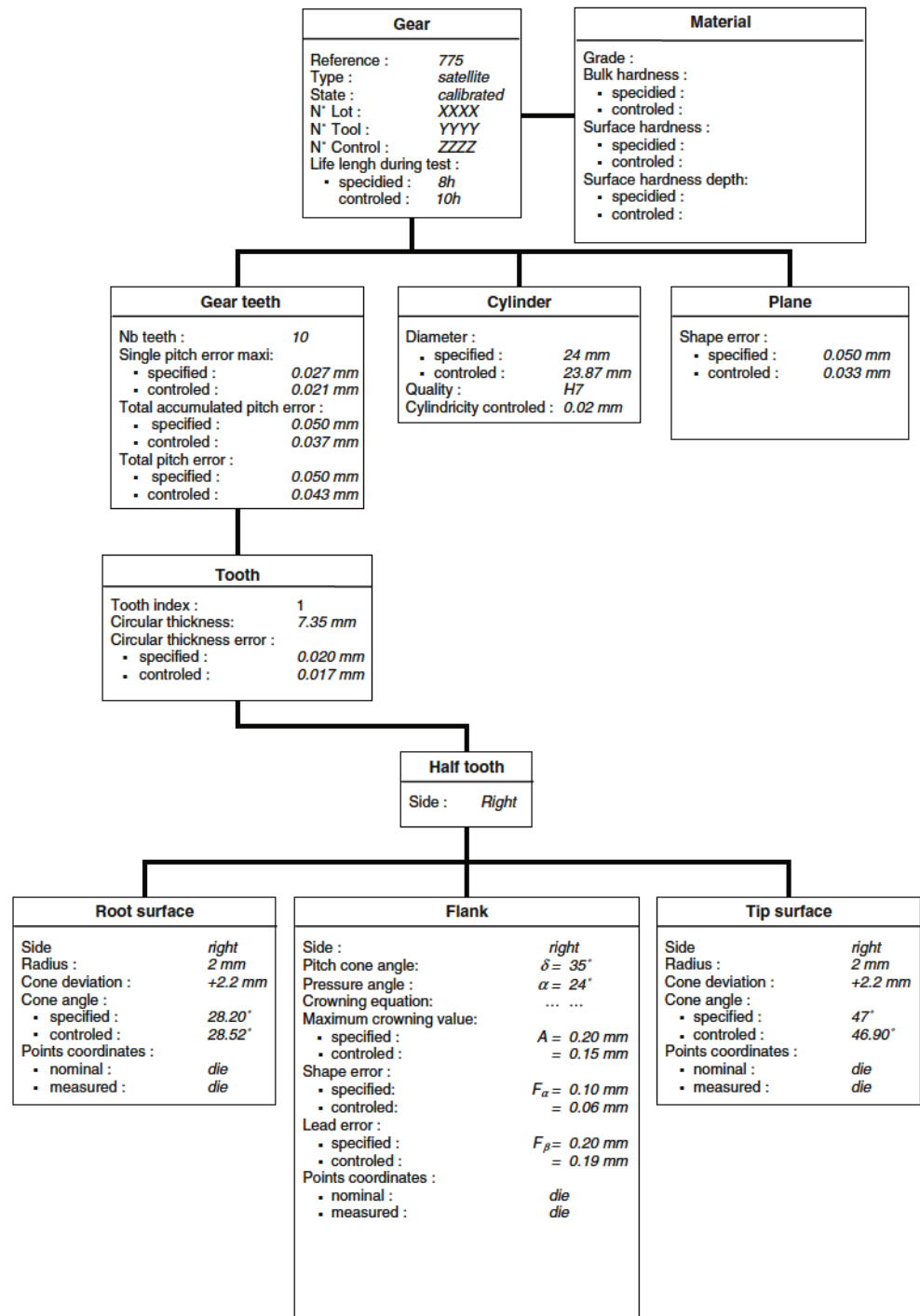

Fig. 3 Influence of a shape defect on pitch inspection

Fig. 4 Partial model of a gear using entities



Then for each non-ideal discretized element, we *Associate* an ideal geometrical surface of the same type according to the criterion of least squares. In addition to the excellent stability and the low sensitivity of this criterion with the aberrant points, it is possible to approach an image of the real functional surface under deformations.

By *Collecting* geometric elements, we can define the system of references for result examinations in accordance with

the indicated specifications. Thus, after the calibrated "State", the system of references will be aligned on the *Collection* of active surfaces of teeth, only finished functional surfaces. However, in the delivery "State", the systems of reference will be aligned on the back plan first and then on the cylinder that better transcript the functionality of assembly and meshing.

After replacing the gear in the space of the machine, geometric errors on the gear are to be determined. The

**Table 1** Initial values needed by the metrologist

Required characteristics	Source	Protagonist	Value of the characteristic 'State'
State of the gear to control (State)	Production	Manufacturer Scheduler	Roughed, calibrated or heat treated
Data of traceability (production run number, die number, type,...)	Production	Manufacturer Scheduler	Initial geometry then.....then roughed then calibrated then...
Nominal geometry ( $m_0, z, \alpha_0, x$ , pitch cone angle, coordinates of nominal points,...)	Knowledge management Computer-Aided Design Simulations of meshing	Designer	Initial geometry
Admissible deviations for geometry (tolerances: $f_p, f_u, f_a, F_p, F_a, F_\beta$ )	Simulations of meshing Process capabilities	Designer Manufacturer	Toleranced geometry
Nominal mechanics characteristics (bulk hardness, surface hardness,...)	General mechanics Metallurgy	Designer Metallurgist	Initial mechanical resistance
Admissible deviations for mechanics characteristics (tolerances: bulk hardness, surface hardness,...)	Metallurgy Process capabilities	Metallurgist	Toleranced mechanical resistance

comparison between measured and theoretical points for each entity enables us to calculate two types of errors:

- position and orientation errors between two elements: the angular position between two associated active flanks gives us the real circular thickness.
- intrinsic form errors to an element: the analysis of the variations between real surface and the associated surface gives the intrinsic defaults such as profile or lead error.

In comparison with the nominal values, we determine the circular thickness, profile or lead errors. This approach, which can work with all the defaults of gears, is coherent

with the one of Pfeifer [12] (Fig. 5). Then, we can identify global error in addition of standard deviation with functional point of view and not only with mathematic point of view.

### 3.3 Application

To illustrate the influence of a local default on the surface of a flank, a bevel gear manufactured has been modified by applying a sticky label. One has been applied on the center of the right flank of the ninth tooth, and the other on the front of the right flank of the eleventh tooth (Fig. 6a).

When using a measurement method according to the ISO standards, the unique point is affected or not, it's binary and

**Fig. 5** Different decompositions of measured surface

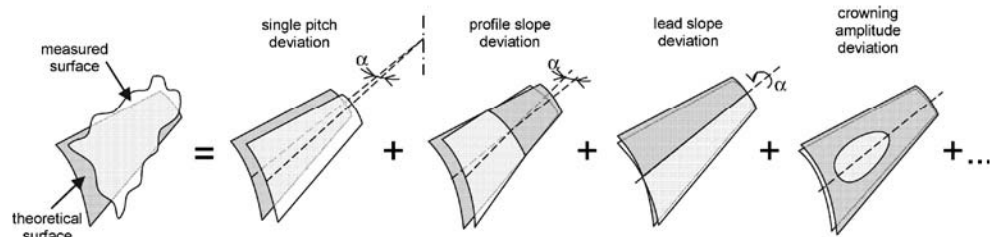

a / functional decomposition

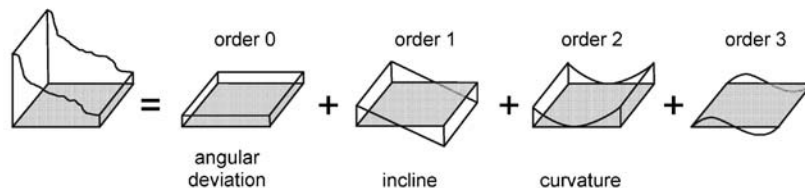

b / mathematical decomposition by T. Pfeifer et al.



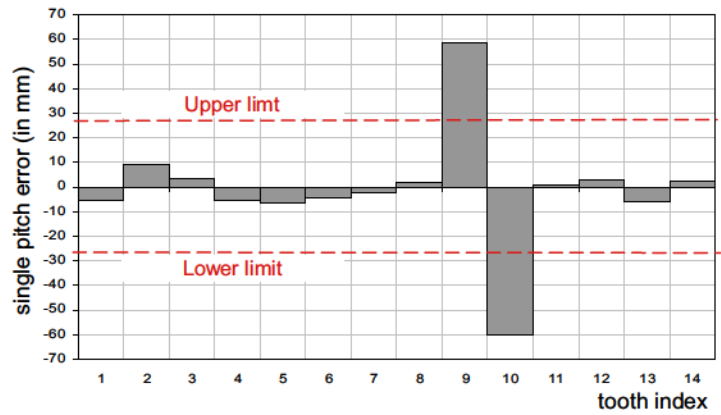
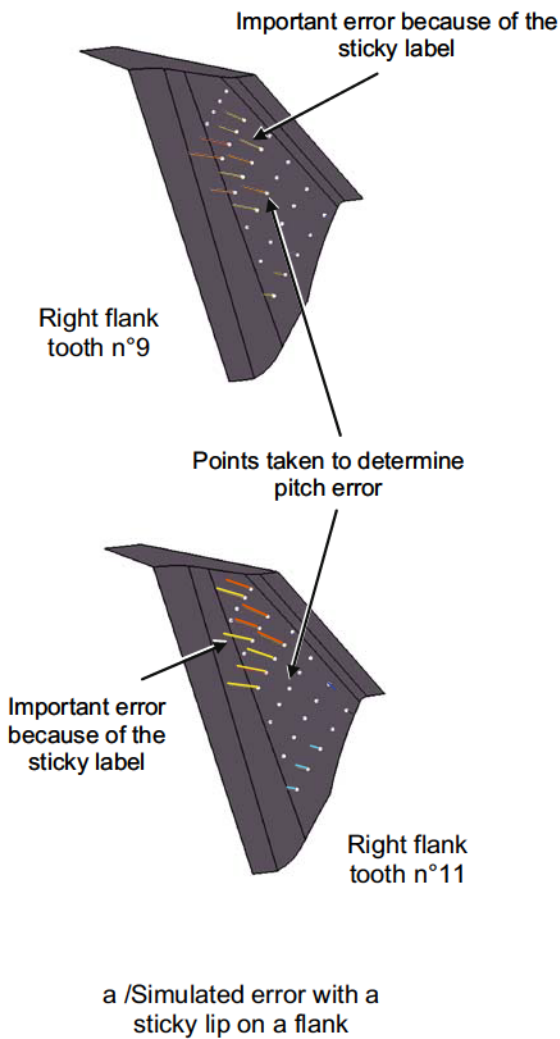

b / Single pitch error on the right determined by a single point on each flank on the pitch circle

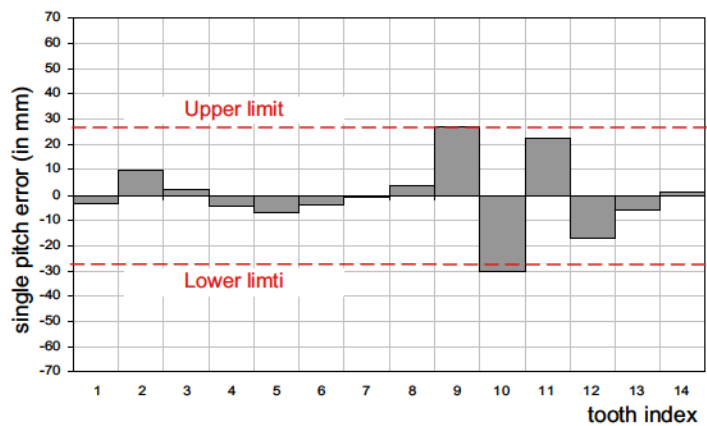

c / Single pitch error on the right determined by a 28 points on each flank brought back on the pitch circle

Fig. 6 Located shape error and single pitch error

the defect amplitude directly equals to the sticky label thickness (60  $\mu\text{m}$ ). For instance, concerning the eleventh tooth, there is no default because the sticky label is not under the measuring point, whereas its influence is important on the meshing (Fig. 6b). When using our approach, the local default is highlighted. Then the amplitude of the pitch error is now proportional to the number of measuring points affected by the sticky label (Fig. 6c). In our case, ten points out of 28 are affected on the flank, so the pitch error value is  $60 \times \frac{10}{28} = 21,5$  micrometers.

Now that we can detect such errors, it is important to go deeper in order to determine whether the gear conforms to the specifications. Indeed, the small proportion of points affected by the sticky label gives small amplitude of pitch error. This could lead to consider the part as conform, whereas the sticky label could affect seriously the meshing. Then, it's important to define correctly the tolerance

interval in order it answers to a functional cinematic requirement [13, 14].

Yet, in this case, gear rolling process is still a complementary control but almost essential to estimate the influence of a local default on gear meshing.

#### 4 Development of a software model for industrial application

A model has been designed with object oriented programming. This reveals to be a good choice knowing that each entity of a gear can be treated as an object, numerically speaking. We used this model at during experiment period on gear measurement in order to improve the manufacturing process, and now, after many improvements of the interface, it is largely used in the industry.

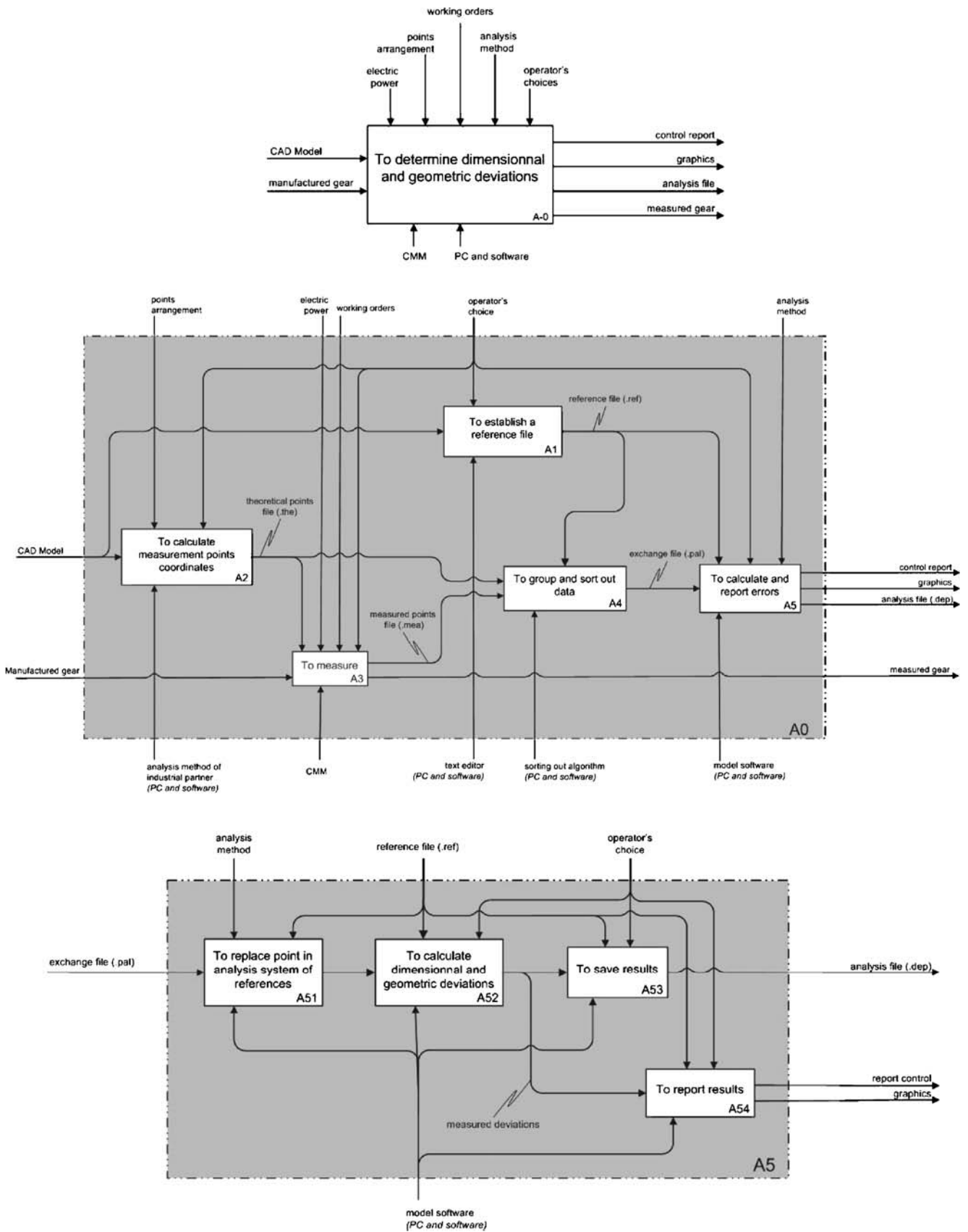
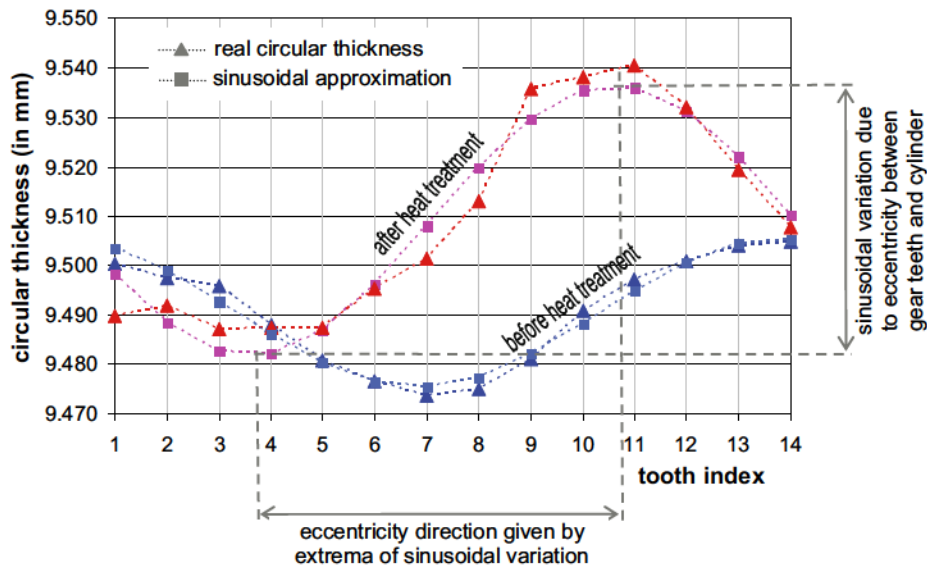
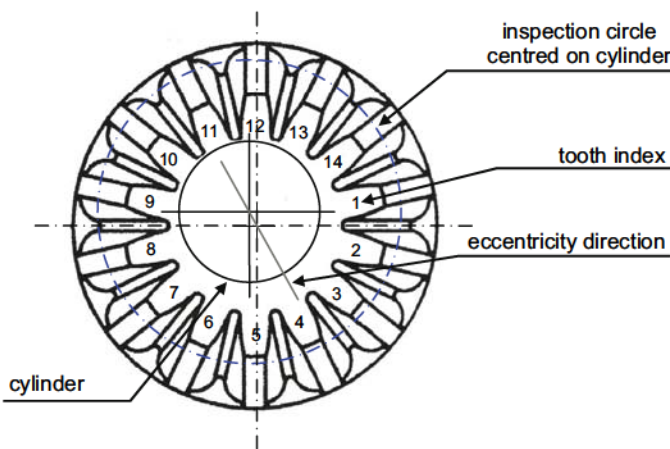

Fig. 7 IDEF0 diagrams of software model





a / circular thickness depending on tooth index



b / eccentricity and circular thickness variation

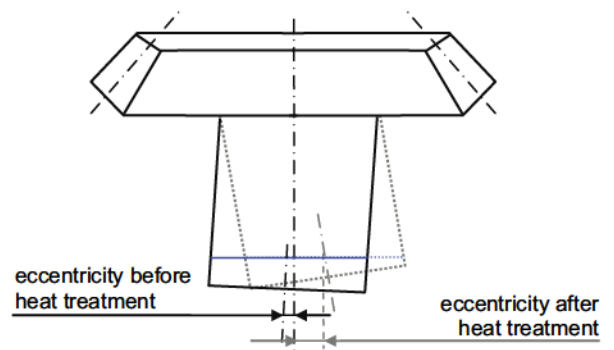

c / eccentricity variation due to heat treatment

Fig. 8 Circular thickness before and after heat treatment

IDEF0 diagrams (Fig. 7) show the numeric model integrated in the gear measurement environment. A-0 block sums up the requirements: a manufactured gear (or a gear being manufactured) has to be compared to his nominal geometry with more than one analysis method (different references systems for instance) and with different density of measuring points. In addition to control report, the operator must be able to read curves for each type of error and to go deeper on one aspect, so the whole set of results has to be saved.

Every time a new geometry comes to the operator, he must enter a set of parameters (teeth number, pitch diameter, points coordinates). Then, once the measurement is done, theoretical points are associated to measured points in a single file called "exchange file". After that, the model

is able to work automatically in order to give the final results the operator has chosen. It is important to notice that the exchange file can be treated with any references system at any time, but during a manufacturing process, this strategy is defined.

## 5 Use of this software model in integrated design

### 5.1 Industrial context

Our approach, implemented in software, is used in industrial context in order to increase quality in manufacturing process. Our plan process, defined by industrial partner, is not only

Fig. 9 Circular thickness and system of references

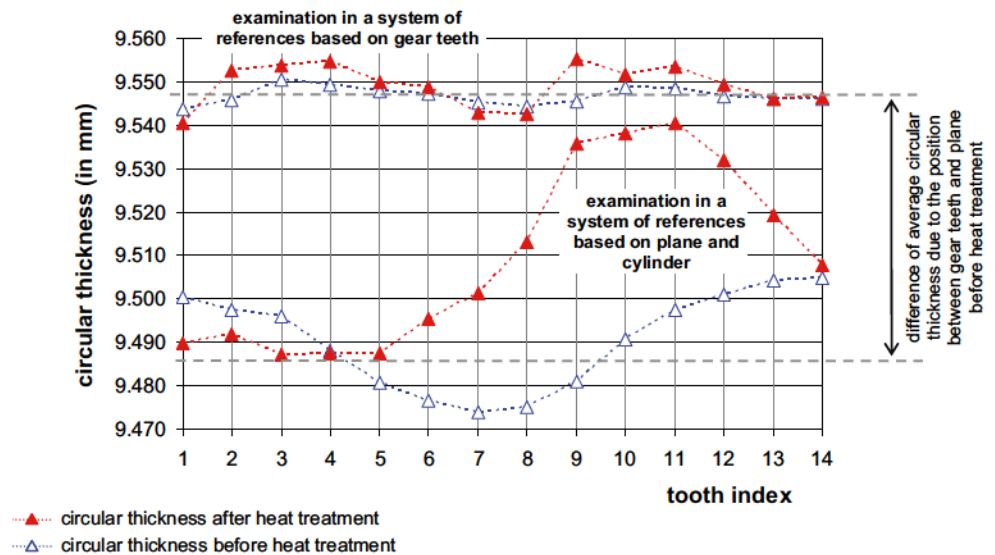

dealing with forging, but also with shearing, hot forging, cold forging and heat treatment [15–17]. Our work is used in industrial context, and concerns each step of the manufacturing process, including die machining. In this paper, we focus on the final heat treatment of net shape forged bevel gear. The next steps concern final quality control before packaging (no machining is done after heat treatment in the studied process). Obviously, heat treatment associated with surface treatment makes metallurgical changes. This microstructure change has consequences on the volume of the part. This deviation is significant on the circular thickness, but not on single pitch.

### 5.2 Whole part inspection

Figure 8a shows the variation of circular thickness on each tooth. References are defined with assembly surfaces: plane and cylinder. Two states of the same part are investigated: before and after heat treatment. We notice that the variation in both of the two states is sinusoidal. This mean there is an eccentricity between external cylinder (assembly surface) and gear teeth (Fig. 8b). Eccentricity direction is defined by the extrema of the curve. Before heat treatment, eccentricity direction is from the 7th and 14th tooth, after heat treatment, the direction has changed to 4th and 11th tooth. So the process has major impact on this phenomenon. Figure 8c illustrates impact of the part’s height on the amplitude and direction of the eccentricity.

### 5.3 Gear teeth inspection

It is necessary to extract information concerning gear teeth regardless of the whole part. It is possible to analyse only the gear teeth with the same set of points and with entity approach. This is a new analysis, but the part is the same.

We only get rid of position defaults between assembly surfaces and gear teeth just by changing system of references.

Figure 9 shows circular thickness in a system of references based on gear teeth. Difference between the mean of each curve gives indication on the linear dimension between plan and gear teeth. Curve amplitude, determined in the system of references based on gear teeth, gives indication on shape error (oval-shaped) of gear teeth. Analysis of gear teeth in the previous reference can not be realized because of the eccentricity amplitude.

## 6 Conclusions

In this paper, we develop a new kind of quality inspection based on entities. They are defined by geometrical analysis of the bevel gear. Our mathematical method enables us to lead an overall analysis and to get results independent of shape default. With the software application, we illustrate our work in industrial context, especially in heat treatment of net shape bevel gears. Deviations are identified entity by entity, but also one in relation with each other.

Further work can be realised in order to optimize design part to limit angular deviation of external cylinder. Another solution to increase final geometric quality is to modify plan process planning. For instance, a final hard turning process can be added after heat treatment. This work can be made in relation between quality inspection and gear rolling process.

**Acknowledgements** The authors would like to express their special thanks to Mr. Muller and Mr. Secordel of ASCOFORGE SAFE for industrial application of this work; Mr. David of L2MA for his scientific discussions and exchanges; and MM. Bastien, Boehm and Morhain for their technical support of this work.

---

## References

1. Goch G (2003) Gear metrology. *Ann CIRP* 52(2):659–695
2. NF\_E\_23-001 (1972) Vocabulaire des engrenages, définitions géométriques. Association Française de normalisation
3. ISO/TR\_10064-1 (1996) Engrenages cylindriques-Code pratique de réception. Partie 1 : Contrôle relatif aux flancs homologues de la denture. Association Française de normalisation
4. ISO\_1122-1 (1997) Vocabulary of gear terms-Part 1: Definitions related to geometry
5. ISO\_1328-1 (1995) Engrenages cylindriques, système ISO de précision. Association Française de normalisation
6. DIN\_3965 (1986) Toleranzen für Kegelradverzahnungen: Grundlagen, Toleranzen für Abweichungen einzelner Bestimmungsgrößen. Deutsches Institut für Normung
7. JIS\_B\_1704 (1984) Accuracy for bevel gears. Japanese Standards Assoc
8. ANSI-AGMA\_2009-B01 (2001) Bevel gear classification, tolerances and measuring methods. Am Gear Manuf Assoc
9. B Slone (2007) New technologies in analytical CNC gear inspection. *Gear Solutions* 2
10. A Ballu Identification de modèles géométriques composés pour la spécification et la mesure par coordonnées des caractéristiques fonctionnelles des pièces mécaniques, Thesis, Université Nancy 1, 1993
11. ISO/TS\_17450-1 (1996) Geometrical product specification (GPS) General concepts-Part 1: Model for geometric specification. Association Française de normalisation
12. Pfeifer T, Kurokawa S, Meyer S (2001) Derivation of parameters of global form deviations for 3-dimensional surfaces in actual manufacturing processes. *Measurement* 29(3):179–200
13. Bruyère J (2006) Contribution à l'optimisation de la conception des engrenages coniques à denture droite. Analyse et synthèse de la géométrie et des tolérances., Thesis, ENSAM, Metz
14. Bruyère J, Dantan JY, Bigot R, Martin P (2007) Statistical tolerance analysis of bevel gear by teeth contact analysis and Monte Carlo simulation. *Mechanism and Mach Theory* (in press)
15. Berviller L, Baudouin C, Bigot R, Leleu S (2003) Technological traceability and circular thickness measurement. Seventh international conference machine building technics and technology, AMTECH 2003, Varna, Bulgaria, 2, pp 1–9, 03–05 October
16. Berviller L, Baudouin C, Bigot R, Leleu S, Martin P (2004) Integrated design and manufacturing of forged parts: illustration of the notion of technological traceability. An example included the activities of design and control of the functionality. Fourth international conference on integrated design and manufacturing in mechanical engineering, Bath, England, April 5–7, 2004
17. Baudouin C (2006) Contribution à la qualification d'un processus de fabrication par une approche dimensionnelle. Application au pignon conique forgé dit "net shape". Thesis, ENSAM, Metz