



Science Arts & Métiers (SAM)

is an open access repository that collects the work of Arts et Métiers Institute of Technology researchers and makes it freely available over the web where possible.

This is an author-deposited version published in: <https://sam.ensam.eu>
Handle ID: <http://hdl.handle.net/10985/7036>

To cite this version :

Fabien MEINGUET, Paul SANDULESCU, Bassel ASLAN, Eric SEMAIL, Xavier KESTELYN, Ngac Ky NGUYEN - Different Virtual Stator Winding Configurations of Open-End Winding Five-Phase PM Machines for Wide Speed Range without Flux Weakening Operation - In: 15th Conference on Power Electronics and Applications (EPE'13 ECCE), France, 2013-09-03 - EPE's 13 Proceeding - 2013

Any correspondence concerning this service should be sent to the repository

Administrator : scienceouverte@ensam.eu



Different Virtual Stator Winding Configurations of Open-End Winding Five-Phase PM Machines for Wide Speed Range without Flux Weakening Operation

N. K. Nguyen, E. Semail, F. Meinguet, P. Sandulescu, X. Kestelyn, A. Bassel
L2EP Laboratory, Arts et Métiers ParisTech, Lille, France

Email : [ngacky.nguyen ; eric.semail ; fabien.meinguet ; xavier.kestelyn]@ensam.eu

Abstract: This paper presents a specific control strategy of double-ended inverter system for wide-speed range of open-winding five phase PM machines. Different virtual winding configurations (star, pentagon, pentacle and bipolar) can be obtained by choosing the appropriated switching sequences of two inverters. The motor's speed range is thus increased.

I. Introduction

Because of large impact of road transportation on carbon emission, researches on Hybrid Electric Vehicles (HEV) have been achieved since many years. Each car manufacturer is proposing hybrid solution. Now, it is necessary to find new solutions which allow a low cost for mass production. For mild-hybrid car solution, a power between 10 to 20 kW has been considered to be an optimal value for recovering most of the available energy during braking and for providing torque assistance in order to downsize the thermal engine. Besides, in order to insure electrical security and to reduce constraints on the Battery Management Systems (BMS), a DC bus value around 48V is attractive. The problem is that for 15 kW the DC bus current is then around to 312 A. For a three-phase drive, the maximum current in Voltage Source Inverter (VSI) MOSFET component has the same value. Such high value is not available with one single MOSFET: Parallel connection is necessary with associated problem of component simultaneity during commutation. In this case, multiphase drives with five or seven phases can provide a solution to the constraint of low-voltage DC bus. Another way to reduce the required current in MOSFET component is to use two 48V-VSIs and a motor in open-end winding configuration. The maximum phase voltage across one phase is then 55V instead of 27.6V in case of wye-coupled three phase drive supplied by only one 48V-VSI. The paper is considering simultaneously the two solutions since it is studying a five-phase open-winding drive.

Beyond the use of a 48V DC-bus voltage, another way to reduce the cost of the drive is to consider an electrical machine whose size is just adapted to torque-speed characteristic of pay-load hybrid application. In this case, it is necessary to design electrical machine with ability to work in constant power mode operation. Typical constant power speed range for a family-car is from 30-40km/h up to 120-150km/h. Electrical machines whose magnetization is insured by current in electrical winding allow to work easily in such constant power operation by flux-weakening operation. Nevertheless, it is also required in hybrid application to choose machine with very high torque and power density because of constraints of volume and mass. It is the reason why Permanent Magnet (PM) Machines whose excitation is insured by PM Magnet are even so used in spite of difficult flux-weakening operation

The challenge is then to design such PM machine adapted to the whole range of constant power range by an adequate design and control in flux-weakening [1] [2]. With a classical wye-coupled machine, the constraint is very strong when the flux weakening range is large. One way to alleviate this constraint on the constant power range is to extend the range of the phase voltage by changing the couplings of the machine. The use of double-end winding machine supplied with two VSIs is a solution. Moreover, with the recent increase of rare-earth Permanent Magnet, the use of a supplementary VSI could be an acceptable solution even more that supplementary degrees of freedom offered by the second VSI can be used for various optimizations [3] [4] [5] [6] [7] [8] [9].

Low voltage DC bus and large flux-weakening range justify the interest for five-phase double-end winding PM drive. The studies on different connections of stator windings for a multi-phase machine are presented in [10] with $(n+1)/2$ possibilities for stator configuration in a n -phase machine. The system looks like a mechanical gear-box with $(n+1)/2$ ratios. In [11] the authors exploited these specificities to increase the rotor speed range using one five-leg VSI and by modifying connection with magnetic contactors. The weak constant power range of the motor alone is thus compensated by a modification of the phase connection. However, because of low time life of magnetic contactors and discontinuous effect during the modification of connection, this solution is not obvious for industrial implementation for automotive application.

The paper proposes an extension of this principle using electronic switching for an open-winding five-phase machine. The two 48V-VSIs are controlled in order to provide similar winding connections as those obtained with magnetic contactor but with an extra-connection called bipolar one. It can be notice that the proposed control strategy is very simple for implementation. An equivalent gear-box with 4 gear ratios is thus obtained. Moreover because of the supply without magnetic contactors, it is rather a Continuous Variable Transmission (CVT) type that can be expected with such a configuration instead of gear-box.

Star, pentagon, pentacle and bipolar connections will be used to overcome a large speed range. By changing virtually the stator connections of an open-end winding five-phase machine supplied by two five-leg Voltage Source Inverters (VSI), torque-speed characteristic is similar to constant power region obtained by flux-weakening operation.

This paper is organized as follow: model of open-winding five-phase PM machine is presented in section II. Section III presents a specific control of dual DC-link for wide speed range without flux weakening operation. Simulation results are given in section IV to confirm the validity of the proposed method. Finally, section V will end the paper by a conclusion. In final paper, experimental results will be provided.

II. Five-phase PM machine and different stator configurations

As mentioned above, there are $\frac{n+1}{2}$ possibilities for stator configuration in an n -phase machine. For a five-phase machine, 3 configurations are thus reported in Figure 1.

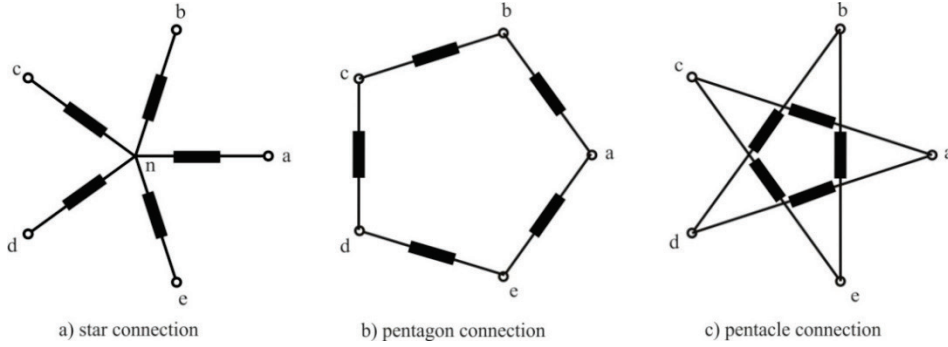

Figure 1. Different possibilities of winding connection in a five-phase machine [10]

Let us define the phase a machine voltage in star connection by:

$$v_{an} = V_m \cos(\theta) \quad (1)$$

For the pentagon connection, the phase a voltage is expressed by:

$$v_{ab} = v_{an} - v_{bn} = V_m \cos(\theta) - V_m \cos\left(\theta - \frac{2\pi}{5}\right) = 2 \cdot V_m \cdot \sin\left(\frac{\pi}{5}\right) \cos\left(\theta + \frac{3\pi}{10}\right) = 1.1756 \cdot V_m \cos\left(\theta + \frac{3\pi}{10}\right) \quad (2)$$

and in pentacle connection, we have:

$$v_{ac} = v_{an} - v_{cn} = V_m \cos(\theta) - V_m \cos\left(\theta - \frac{4\pi}{5}\right) = 2 \cdot V_m \cdot \sin\left(\frac{2\pi}{5}\right) \cos\left(\theta + \frac{\pi}{10}\right) = 1.9 \cdot V_m \cos\left(\theta + \frac{\pi}{10}\right) \quad (3)$$

By changing these stator configurations, speed wide range of machine can be extended as shown in Figure 2 [11]. It can be noticed that in [11] the change of connection is obtained by the magnetic contactors which presents time delay. When machine is running, it is not recommended to change on-line between these stator configurations by the magnetic contactors.

In next section, a structure of an open-winding five phase machine connected to two isolated inverters (Figure 3) is used. Thanks to specific control of these two VSI, different virtually stator winding configurations are obtained to increase the speed range of the PM machine.

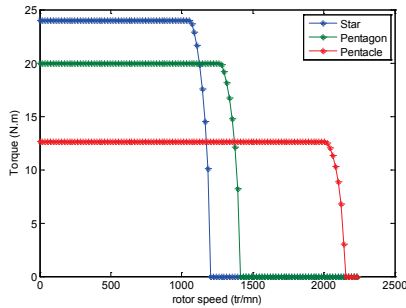

Figure 2. Torque-speed characteristics with different stator configurations given in Figure 1

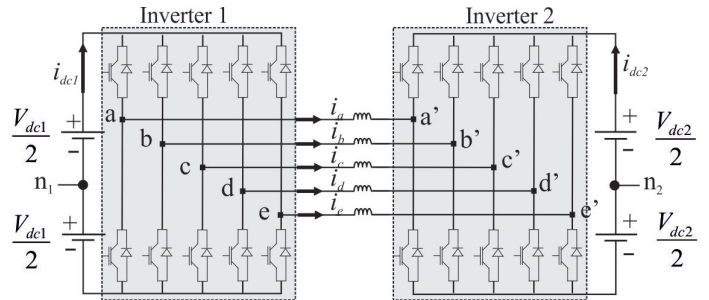

Figure 3. Double-ended inverters open-winding five-phase PM machine structure

III. Specific control of dual DC-link for wide speed range

1. Modeling of Open-winding Five-phase PM Machine

The stator machine voltages are determined by:

$$\mathbf{v}_{abcde} = \mathbf{v}_{abcde-INV1} - \mathbf{v}_{abcde-INV2} + \mathbf{v}_{abcde-n_1n_2} \quad (4)$$

with :

$$\begin{aligned} \mathbf{v}_{abcde} &= [v_{aa'} \quad v_{bb'} \quad v_{cc'} \quad v_{dd'} \quad v_{ee'}]^T \\ \mathbf{v}_{abcde-INV1} &= [v_{an_1} \quad v_{bn_1} \quad v_{cn_1} \quad v_{dn_1} \quad v_{en_1}]^T \\ \mathbf{v}_{abcde-INV2} &= [v_{a'n_2} \quad v_{b'n_2} \quad v_{c'n_2} \quad v_{d'n_2} \quad v_{e'n_2}]^T \\ \mathbf{v}_{abcde-n_1n_2} &= [v_{n_1n_2} \quad v_{n_1n_2} \quad v_{n_1n_2} \quad v_{n_1n_2} \quad v_{n_1n_2}]^T \end{aligned} \quad (5)$$

We can notice that the two vectors $\mathbf{v}_{abcde-INV1}$ and $\mathbf{v}_{abcde-INV2}$ are constituted by the voltage components having three levels: +E, -E where $2E=V_{dc}=V_{dc1}=V_{dc2}$ (V_{dc1} is considered equal to V_{dc2}). If the machine voltages are balanced, we have: $\mathbf{v}_{abcde}^T \cdot \mathbf{u} = 0$ with $\mathbf{u} = [1 \quad 1 \quad 1 \quad 1 \quad 1]^T$. The stator voltage vector can be thus expressed as:

$$\mathbf{v}_{abcde} = \mathbf{A} \cdot (\mathbf{v}_{abcde-INV1} - \mathbf{v}_{abcde-INV2}) \quad (6)$$

$$\text{with } \mathbf{A} = \frac{1}{5} \begin{bmatrix} 4 & -1 & -1 & -1 & -1 \\ -1 & 4 & -1 & -1 & -1 \\ -1 & -1 & 4 & -1 & -1 \\ -1 & -1 & -1 & 4 & -1 \\ -1 & -1 & -1 & -1 & 4 \end{bmatrix}$$

Seeing that two VSI are isolated, the first one can be separately controlled with the second one and vice-versa. Different machine voltage levels can be archived by applying appropriated switching sequences to control the two inverters. This means that different virtual stator winding configurations can be obtained.

2. Specific control strategies

a. Virtual star connection (Figure 1.a)

Indeed, machine neutral point is created when all points a', b', c', d', and e' are connected together. In this type of connection, all down-switch of the second VSI are ON, it means, $\mathbf{v}_{abcde-INV2} = [0 \quad 0 \quad 0 \quad 0 \quad 0]^T$. The machine voltage vector is thus given as follow:

$$\mathbf{v}_{abcde-star} = \mathbf{A} \cdot \mathbf{v}_{abcde-INV1} \quad (7)$$

b. Virtual pentagon connection (Figure 1.b)

In pentagon connection, the phase voltage is given by expression (2). For this, we have to define, for the second VSI, the output voltages satisfying following condition:

$$v_{a'n_2} = v_{bn_1}; v_{b'n_2} = v_{cn_1}; v_{c'n_2} = v_{dn_1}; v_{d'n_2} = v_{en_1}; v_{e'n_2} = v_{an_1} \quad (8)$$

The voltage vector is rewritten as:

$$\mathbf{v}_{abcde-pentagon} = \mathbf{A} \cdot [v_{an_1} - v_{bn_1} \quad v_{bn_1} - v_{cn_1} \quad v_{cn_1} - v_{dn_1} \quad v_{dn_1} - v_{en_1} \quad v_{en_1} - v_{an_1}]^T = \mathbf{A} \cdot [v_{ab} \quad v_{bc} \quad v_{cd} \quad v_{de} \quad v_{ea}]^T \quad (9)$$

It can be remarked that with the obtained voltage in expression (9), we can considerer that the PM machine is virtually connected in pentagon.

c. Virtual pentacle connection (Figure 1.c)

In the same manner, a virtual pentacle connection of open-winding five-phase machine can be archived when the expression (10) is satisfied.

$$v_{a'n_2} = v_{cn_1}; v_{b'n_2} = v_{dn_1}; v_{c'n_2} = v_{en_1}; v_{d'n_2} = v_{an_1}; v_{e'n_2} = v_{bn_1} \quad (10)$$

$$\mathbf{v}_{abcde-pentagon} = \mathbf{A} \cdot \begin{bmatrix} v_{an_1} - v_{cn_1} & v_{bn_1} - v_{dn_1} & v_{cn_1} - v_{en_2} & v_{dn_1} - v_{an_1} & v_{en_1} - v_{bn_1} \end{bmatrix} = \mathbf{A} \cdot \begin{bmatrix} v_{ac} & v_{bd} & v_{ce} & v_{da} & v_{eb} \end{bmatrix} \quad (11)$$

d. Virtual « bi-polar » connection (Figure 4)

For one phase, the machine voltage can be maximized if two legs that feed this phase are controlled by bi-polar mode control as H-Bridge converter. It means that the upper-switch of the first leg is turned on in the same time with the lower-switch of the second leg and vice-versa. Consequently, we have:

$$v_{a'n_2} = -v_{an_1}; v_{b'n_2} = -v_{bn_1}; v_{c'n_2} = -v_{cn_1}; v_{d'n_2} = -v_{dn_1}; v_{e'n_2} = -v_{en_1} \quad (12)$$

and the machine voltage is thus expressed:

$$\mathbf{v}_{abcde-bipolar} = 2 \cdot \mathbf{A} \cdot \mathbf{v}_{abcde-INV1} \quad (13)$$

It can be noticed that with this control strategy, the voltage machine magnitude is two times greater than the one obtained by star configuration.

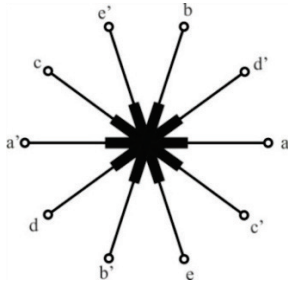

Figure 4. Machine voltages obtained by bipolar control strategy

3. Flow-chart for control

The control algorithm is reported in Figure 5. Without flux-weakening operation, a wide speed range can be increased when the stator winding of machine is reconfigured. The VSI control is very simple. Based on this algorithm, the next section is dedicated to present simulation results.

IV. Simulation results

In this section, several simulations on Matlab/Simulink are presented. The parameters of machine and mechanical load are given as follow:

Phase resistance:	$R=2.24 \Omega$	$k_{emf-1} = E_1 / \Omega = 0.32 \text{ (V.s.rad}^{-1}\text{)}$
Inductance :	$L_{1d}=3.2 \text{ mH}$	Maximum torque $T_{em-max}=20 \text{ N.m}$
Inductance	$L_{1q}=3.2 \text{ mH}$	Maximum speed $\Omega_{max} = 2500 \text{ rpm}$
Inductance	$L_{3d}=0.9 \text{ mH}$	Bus voltage $V_{bus}=70 \text{ V}$
Inductance	$L_{3q}=0.9 \text{ mH}$	Maximum phase current $I_{max}=15 \text{ A}$

Table 1. Parameters of the open-five phase machine used in numerical simulations

With different configurations of machine, the maximum voltages are obtained by:

$$\begin{bmatrix} V_{dq \max-pentagon} & V_{dq \max-pentacle} & V_{dq \max-bipolar} \end{bmatrix} = V_{dq \max-star} \begin{bmatrix} 1.1756 & 1.9 & 2 \end{bmatrix} \quad (14)$$

So simplify the study, only main machine in $d-q$ synchronous reference frame is used; the auxiliary machine is thus not excited. With the machine's parameters in Table 1, we have the different base speeds according to different stator configurations [1] [4]. The control algorithm is based on Figure 5. A mechanical load is 1.5 N.m.

The desired and rotor speeds (in p.u) are shown in Figure 6.a). The machine is operated according to the control algorithm presented in Figure 5. Indeed, there is no the flux-weakening operation in the proposed approach. The rotor speed is increased by a reconfiguration of stator winding which is obtained by the control of two VSI. The rotor speed is increased progressively. Maximum rotor speed is increased approximately 2 times according to the one obtained by the wye-connection. Figure 6.b) shows the load torque required and the electromagnetic torque developed by the PMSM. The speed and current controllers are based on the PI controllers. We can remark that PI controllers have a good

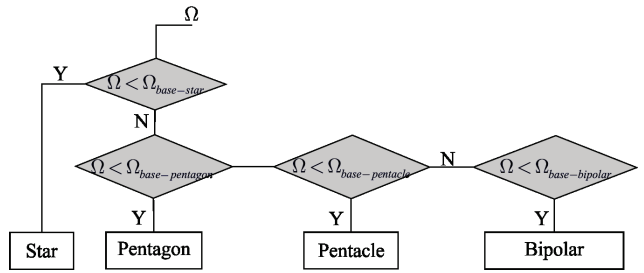

Figure 5. Flow-chart control strategy

performance because the machine and load parameters are well-known. The voltages are shown in Figure 6.c) (only phase a) and Figure 6.d) in natural and synchronous $d-q$ reference frames respectively. The difference of voltage magnitude is clearer when the voltages are shown in $d-q$ reference frame. Indeed, the magnitude of $V_{dqmax-pentagon}$ is 1.1756 greater than $V_{dqmax-star}$ and when machine is virtually connected in pentacle or bipolar, the voltage magnitude is 1.9 and 2 times greater. This result is accorded to the theory.

Figure 6.e) gives the phase currents of the machine. The dynamic response of current is good. It can be noticed that only the principle machine is used. The reference voltages of the auxiliary machine are set up at zero. Figure 6.f) gives the $d-q$ current of the principle machine.

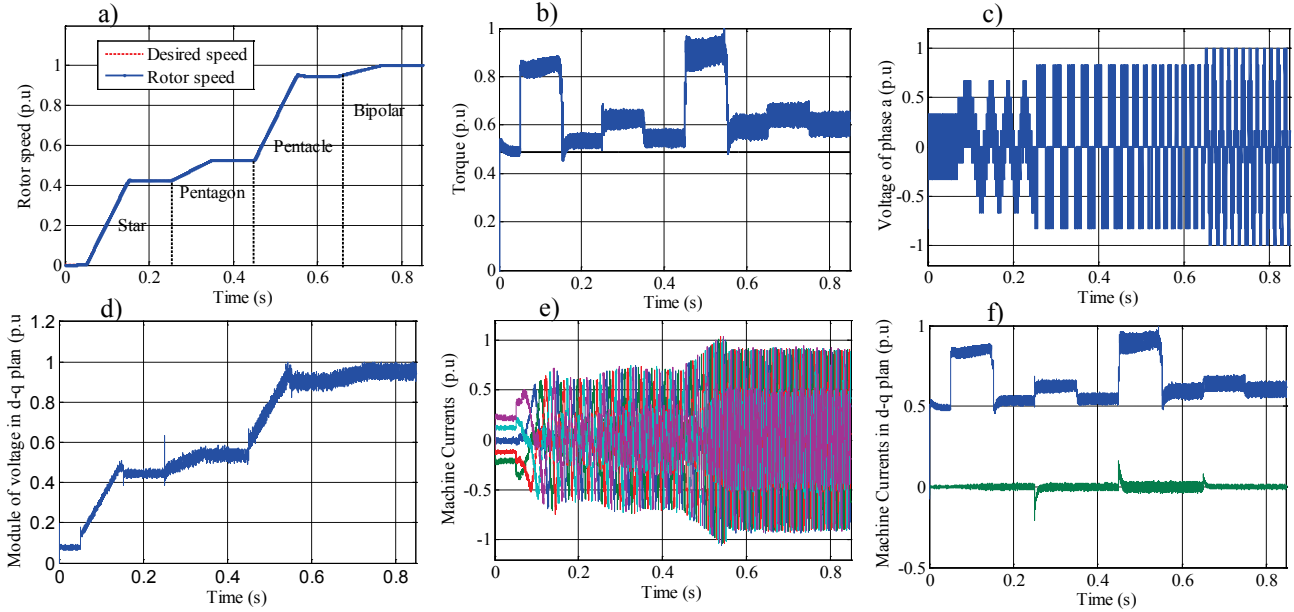

Figure 6 : Simulation results: a) Speed response; b) Electrometric torque; c) Phase a voltage; d) Module of voltage $|V_{d-q}|$; e) Currents of the machine; f) Currents of the machine in $d-q$ reference frame.

V. Experimental results

In order to validate the proposed control strategy, a practical test-bench has been carried out and shown in Figure 7.

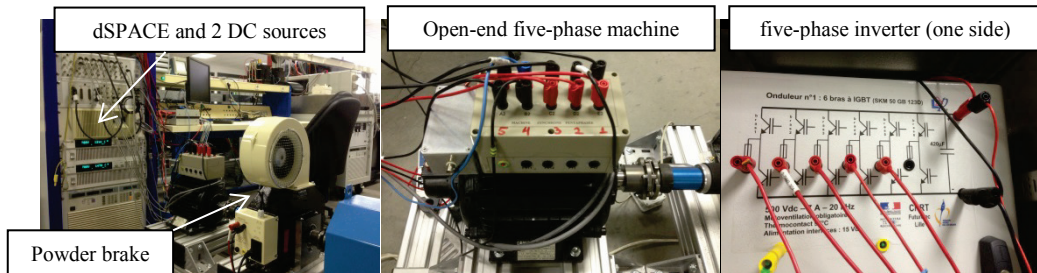

Figure 7 : Laboratory experimental platform setup

Two DC-sources are set to 70V. With this value of DC-voltage, the maximum speed of different connections are calculated as: 80rad/s for star, 100rad/s for pentagon, 180 rad/s for pentacle and 190 rad/s for bipolar. So, a PI speed controller was employed. A magnetic powder brake is used as mechanical load. The PWM frequency is fixed at 10 KHz and the sampling time is chosen 100 μs .

Experimental results are shown in Figure 8. The speed response is obtained in Figure 8.a). Due to limit of bandwidth of a PLL used to track the rotor position, there is a small error during acceleration but it is acceptable. The machine voltages are shown in Figure 8.c) and d) in Concordia and Park reference frames respectively. It has been shown that the amplitude of voltage is verified by equation (14). All the simulation results are verified by experimentation. It can be noticed that in pentagon connection, the current is more distorted because of presence of high amplitude in auxiliary machine. For this reason, a pentacle connection can be used directly without pentagon connection.

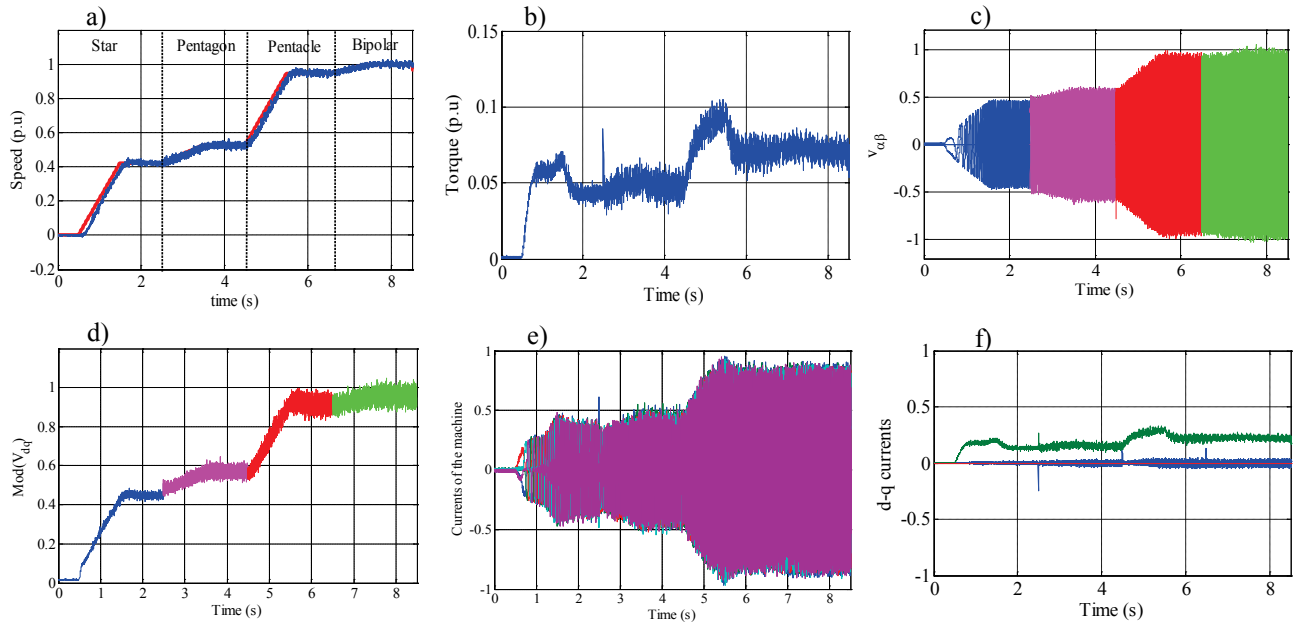

Figure 8 : Experimental results: a) Speed response; b) Electrometric torque; c) Voltages in Concordia reference frame; d) Module of voltage $|V_{d-q}|$; e) Currents of the machine; f) Currents of the machine in $d-q$ reference frame

VI. Conclusion

A specific control strategy of five-phase open winding machine is presented in this paper. In order to increase the rotor speed without exceed of voltage limit and without flux weakening operation, different virtual stator configurations are obtained by the control of two VSIs of an open-end winding machine torque-speed characteristic is thus similar to constant power region obtained by flux-weakening operation. Simulation and experimentation results have been presented to confirm the validity of the proposed approach. It can be noticed that the control algorithm is very simple to implement in real-time. Concerning the strategy of control, the chosen approach in the paper is similar to this one used with a mechanical gear-box with 4 gear ratios. In fact, using double end windings configuration instead of magnetic contactors, a strategy of control similar to this one of a Continuous Variable Transmission (CVT) could also be implemented in a mixed control using flux-weakening abilities of the machine in association with virtual connections.

Reference

- [1] M. Tursini, E. Chiricozzi, and R. Petrella, "Feedforward Flux-Weakening Control of Surface-Mounted Permanent-Magnet Synchronous Motors Accounting for Resistive Voltage Drop," *IEEE Trans. on Industrial Electronics*, vol. 57, no. 1, pp. 440-448, 2010.
- [2] L. Lu, E. Semail, L. Kobylanski, and X. Kestelyn, "Flux-Weakening Strategies for a Five-Phase PM Synchronous Machine," *Proceedings of the 2011 - 14th European Conference on Power Electronics and Applications (EPE 2011)*, 2011, pp. 1-7.
- [3] B Welchko et al, "Double ended inverter system with an impedance source inverter subsystem" Patent US 2011/7956569B2
- [4] A.-P. Sandulescu, F. Meinguet, X. Kestelyn, E. Semail, and A. Bruyère, "Flux-weakening operation of open-end winding drive integrating a cost effective high-power charger," *IET Electrical Systems in Transportation*, 2013 (Accepted for publication).
- [5] M. M. Swamy, T. Kume, A. Maemura, and S. Morimoto, "Extended high-speed operation via electronic winding-change method for AC motors," *IEEE Trans. on Industry Applications*, vol. 42, no. 3, pp. 742-752, 2006.
- [6] B. A. Welchko, "A double-ended inverter system for the combined propulsion and energy management functions in hybrid vehicles with energy storage," in *31st Annual Conference of IEEE Industrial Electronics Society, IECON 2005*, 2005.
- [7] K. Mu-Shin and S. Seung-Ki, "Flux Weakening Control of an Open Winding Machine with Isolated Dual Inverters," in *IAS 2007- 42nd Annual Meeting on Industry Applications Conference, Conference Record of the 2007 IEEE*, 2007, pp. 251-255.
- [8] Y. Wang, T. A. Lipo, and D. Pan, "Robust operation of double-output AC machine drive," in *Power Electronics and ECCE Asia (ICPE & ECCE), 2011 IEEE 8th International Conference on*, 2011, pp. 140-144.
- [9] N. Bodo, E. Levi, M. Jones, "Enhanced decoupling PWM methods for five-phase open-end winding drives," *Electrical Machines (ICEM), 2012 XXth International Conference on*, pp.939-945, 2-5 Sept. 2012
- [10] D. Dujic, M. Jones, and E. Levi, "Analysis of Output Current-Ripple RMS in Multiphase Drives Using Polygon Approach," *IEEE Trans. on Power Electronics*, vol. 25, no. 7, pp. 1838-1849, 2010.
- [11] S. Sadeghi, G. Lusu, H. A. Toliyat, and L. Parsa, "Wide Operational Speed Range of Five-Phase Permanent Magnet Machines by Using Different Stator Winding Configurations," *IEEE Trans. on Industrial Electronics*, vol. 59, no. 6, pp. 2621-2631, 2012.