

PANTOGRAPH CATENARY DYNAMIC OPTIMISATION BASED ON ADVANCED MULTIBODY AND FINITE ELEMENT CO-SIMULATION TOOLS

C. Laurent*, J.-P. Massat^π, T.M.L. Nguyen-Tajan^π, J.-P. Bianchi[†], E. Balmes[†]
[†]: SDTools, Paris, France

*: Vibrateam (Vibratec group), Lyon, France

^π: SNCF Innovation & Research Department, Paris, France

40 Avenue des Terroirs de France
75 611 PARIS CEDEX 12, FRANCE

jean-pierre.massat@sncf.fr

Abstract

This paper presents recent developments undertaken by the SNCF Innovation & Research Department on numerical modelling of pantograph catenary interaction. It aims at describing an efficient co-simulation process between Finite Element (FE) and Multibody (MB) modelling methods. The FE catenary models from the SNCF's software, OSCAR[®], are coupled with a full flexible MB representation with pneumatic actuation of pantograph. These advanced functionalities allow new kind of numerical analyses such as dynamical improvements based on a passive pneumatic suspension or crash risks assessment in railway switches that demonstrate the powerful capabilities of this computing approach.

1. INTRODUCTION

The railway system performance was historically improved by inline tests. Considering the constant traffic increase and the need to cut costs, new assessment methods have to be found to propose higher expertise level at lower prices. Numerical solutions are the most promising way to achieve this goal particularly with tools getting closer from track conditions while cutting down the computation time. In railways, the development of efficient simulation approaches becomes mandatory to design new components or to optimize maintenance. Therefore, various modelling strategies can be employed according to the need in order to find the best compromise as it can be illustrated on pantograph catenary dynamic interaction researches^[1].

OSCAR^{®[2, 3, 4]} (Outil de Simulation du CAptage pour la Reconnaissance des défauts) has been developed by SNCF company for nearly ten years and certified against the EN50318 European Standard^[5] in 2007. It proposes efficient pantograph catenary dynamical analysis tools based on SDTools libraries. It allows to model FE catenaries with a three-dimensional geometry interacting with lumped mass as well as multibody pantograph models^[6]. Several studies showed a really good agreement between OSCAR[®] results and inline measurements for different catenary designs in Europe^[7]. This paper presents a new powerful functionality of OSCAR[®] which allows to extend the use of this software to other fields of study through a co-simulation process with an external solver for a higher pantograph modelling detail level. A full flexible MB methodology with control system based on MSC Software computing solutions has been developed in order to take into account realistic pantograph geometry, large kinematic displacements, pneumatic actuation and joints, non linearities in suspensions and dampers.

The multi-disciplinary model of a French high speed pantograph is firstly presented to describe in details structural and pneumatic control components. The overall pantograph system is coupled with a FE catenary for time dynamic simulations. It combines the advantages of a FE representation of the catenary and the efficiency of MB methods for pantograph modelling. The co-simulation process is then detailed. Results of a numerical validation are given through a comparison between a full co-simulation (FE catenary / MB pantograph) and a full OSCAR[®] simulation using an equivalent three lumped mass model. Two distinct applications are proposed in this paper. First, an optimisation process is presented to demonstrate the large improvements that could be foreseen on current collection quality using an enhanced passive pantograph head suspension with innovative pneumatic functionalities. Second, a strategy is developed to use MB modelling for risky catenary sections such as railway switch characterisation and assessment. This last study is focused on consequences of critical positioning of the Contact Wire (CW) leading to lateral horns of pantograph straddling.

2. FINITE ELEMENT CATENARY MODELLING

The three dimensional catenary is modeled using OSCAR[®] software. It takes into account all non-linearities present in the system: bumpstops, friction elements in the pantograph; non linear droppers in the catenary; contact losses at the interface. It also manages the wave propagation and the coupling of flexible structures through a load moving on a FE mesh^[3, 4, 8, 9, 10]. Our simulation cases will be focused on simplified pre-tensioned wires for railway crossing area analysis and on the French high speed line LN2 (Paris-Tour) for pneumatic suspension optimisation. The LN2 FE catenary model is shown on Figure 1 with the description of the main compounds.

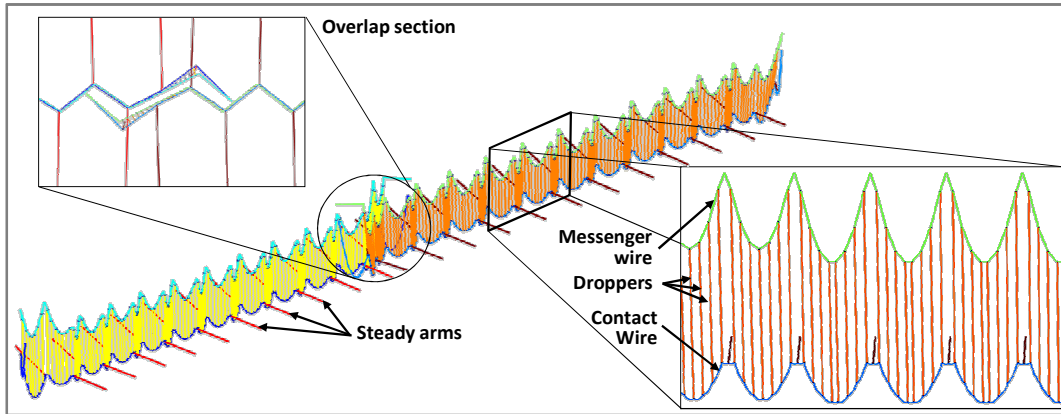

Figure 1 - Finite element model for two sections of the French High Speed catenary

3. MULTIBODY PANTOGRAPH MODELLING

Recent developments undertaken by SNCF Innovation & Research department were led to achieve a multi-disciplinary model of a French high speed pantograph including realistic mechanical features such as joint bushing, realistic actuation system with pneumatic control or even advanced tools to apply external excitations such as aerodynamic loads or car body displacements.

3.1 A highly detailed description of the geometry

The Figure 2 illustrates the particularly high detailed pantograph geometry. The main frame of the pantograph, composed of arms and rods, reproduces large displacements. It is actuated by a pneumatic piston that translates and applies a torque to the lower arm through a cam-cable link. The description of the cam shape is significant in model results because it is designed to ensure a nearly constant mean contact load whatever the deployment. In the same way, non-linear dampers on the main frame can be introduced in the model. The upper part, named bow, is a centrepiece of the pantograph because its shape defines the interoperability capability and the aerodynamic sensitivity of the pantograph and its weight establishes the dynamic interaction quality with the overhead line. As shown on the Figure 2, the MB bow is made of friction bands (contact strips) and lateral horns. The MB model with a highly detailed description of the geometry brings a real benefit compared to a three lumped mass model, particularly to assess the compatibility with infrastructure.

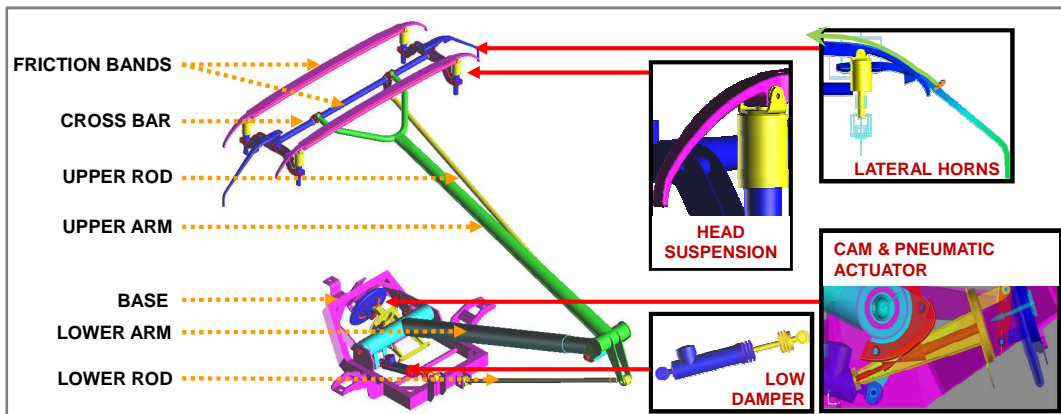

Figure 2 - Pantograph key components for multibody modelling

3.2 Structural flexibility and properties adjustment

Mechanical and structural parameters for dynamic representation and flexible bodies modelling are fitted from laboratory measurements and a full experimental modal analysis. It enables to reproduce pantograph dynamic behaviour in three dimensions up to 200Hz^[11]. Flexible elements are introduced in the MB model based on the Craig-Bampton condensation method that uses static modes and modal basis at node's interface. In the usual frequency band of interest defined between 0 and 20Hz for general pantograph catenary analysis, the structural flexibility of the upper frame combined with flexible bow elements appears to be essential to reproduce the proper dynamical behaviour of the mechanical system. The three first vertical modes calculated in this frequency bandwidth are illustrated on the Figure 3.

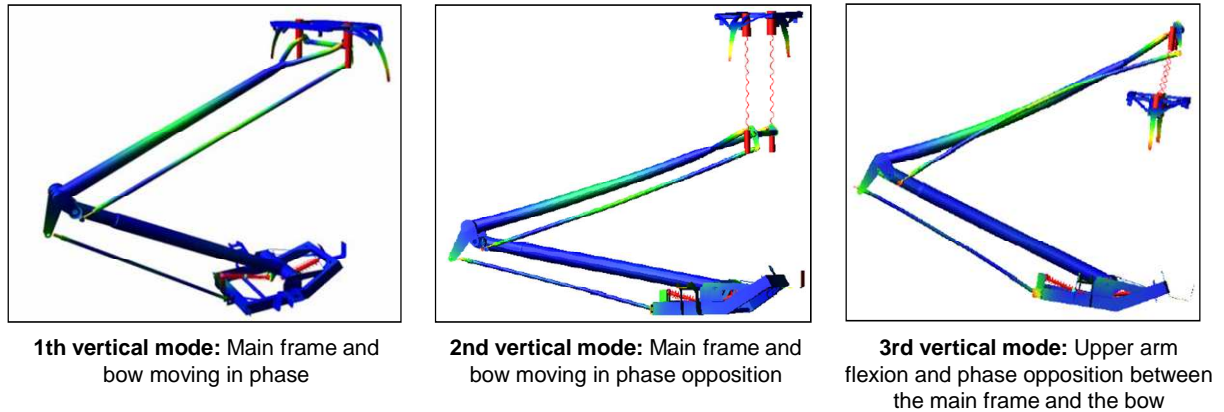

Figure 3 - Three first vertical modes of the pantograph in the [0,20Hz]

The Figure 4 shows the impact of flexibilities in terms of dynamic impedance. The comparison is given between a fully rigid, a partially flexible and a full flexible pantograph. Comparing the full rigid model with the partially flexible one, we can observe the necessity to add flexibility into the upper arm and rod as well as the bow to reproduce the third vertical mode and to adjust the second vertical mode amplitude. Moreover, taking into account bushing between friction bands and head suspension seems to reduce pantograph second and third resonances response for a same load as underlined by the two green curves. To finish, one can see the need to take the wholes pantograph component flexibilities into account to clearly draw the third vertical mode.

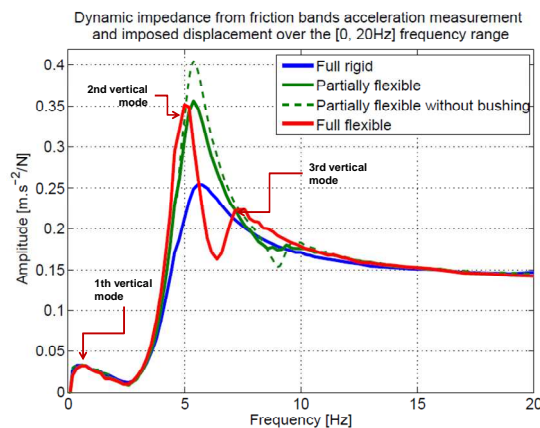

Figure 4 - Dynamic impedance comparison as a function of pantograph flexible elements in the [0,20Hz] range.

3.3 Control system for pneumatic actuation

The pantograph is equipped by a pneumatic actuator which delivers a tabulated pressure established on an electronic card and usually related to train speed. Besides, the device is connected to the train's global air network and delivers compressed air using a pneumatic regulation system. Therefore, the pressure applied on the actuator's piston results from an open loop for the pressure instruction and a closed loop system to adjust the output pressure. The numerical model is achieved to reproduce the pneumatic functionalities and convert pressure signals into mechanical load properties. The mechanical piston displacements is sent by the MB model to the control system

that returns the pneumatic load applied on piston surface. The electronic card is reproduced and uses train speed information given in real time during numerical calculation to adjust the pressure instruction. Moreover, the closed loop for pressure regulation is modeled by a PID to control pressure fluctuations as illustrated on Figure 5.

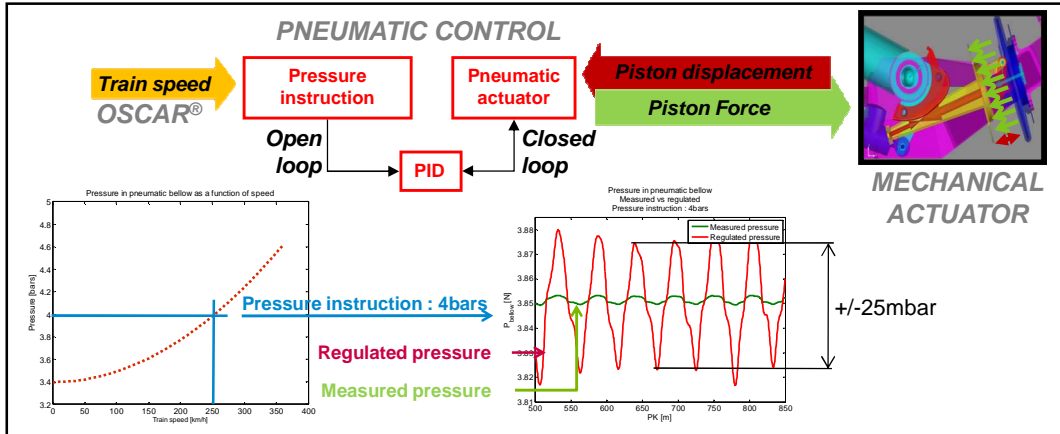

Figure 5 - Pneumatic control system block diagram and communication process with multibody pantograph and OSCAR®

4. CO-SIMULATION PROCESS AND NUMERICAL VALIDATION

4.1 Co-simulation process

The key concept of pantograph catenary co-simulation process is to connect two software using computer Random Access Memory to perform a real time simulation at a fixed time step. Communication entities are modelled within the MB software and correspond to short pieces of CW. Contact properties are defined between friction bands and communication entities to allow contact load calculation. After communication entities creation, the catenary static state is obtained to send the initial position of the CW pieces. An optional pantograph static adjustment is then implemented and the iterative co-simulation process is launched for a given time step defined by OSCAR®. The contact load computed by the MB software is applied on the FE catenary; OSCAR® performs the FE catenary calculation and returns CW displacements to the MB solver at the updated pantograph position along the catenary. This position depends on train speed. The full co-simulation process is shown on Figure 6.

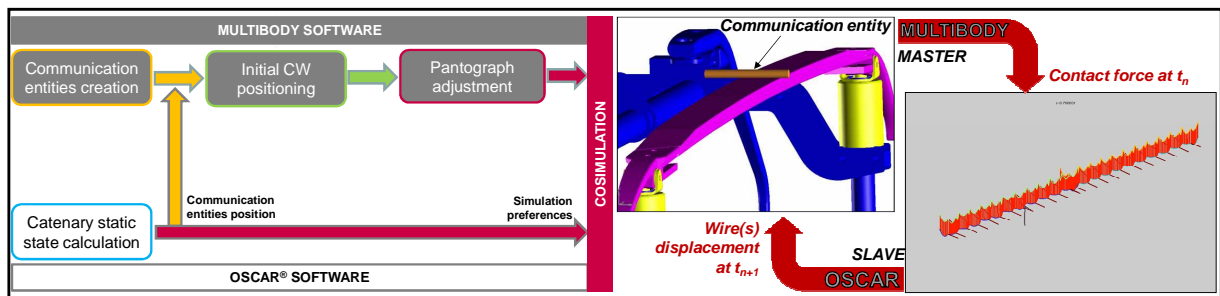

Figure 6 - Co-simulation process between OSCAR® (EF catenary modelling) and the MB software (MB pantographe modelling)

The contact load is calculated by the MB software. It is defined as a Hertz contact with Coulomb friction with the following properties.

$$\begin{cases} F_N = k_c \cdot g^{Ex} + C_m \cdot \frac{dg}{dt} \\ F_N \cdot \frac{dg}{dt} = 0 \end{cases} \quad \text{With} \quad \begin{cases} g & \text{Bodies' interpenetration} \\ k_c & \text{Contact stiffness} \\ Ex & \text{Normal force exponent applied on interpenetration value} \end{cases}$$

Further constraints are moreover applied to ensure impenetrability, gap between bodies, contact load positivity and energy conservation.

4.2 Numerical validation

The co-simulation process needs to be numerically validated to evaluate deviations. The procedure composed by three main steps described on Figure 7 is applied. Dynamic impedance is obtained on three positions (friction bands, upper arm, and knee) by imposed displacement on the full flexible MB pantograph (1st step). The simplified three lumped mass model is identified with a Non Gradient Optimisation (NGO) method by fitting the computed Frequency Response Functions (2nd step). Finally, the co-simulation over 400m of the French LN2 catenary is performed and compared with a pure OSCAR[®] simulation (3rd step).

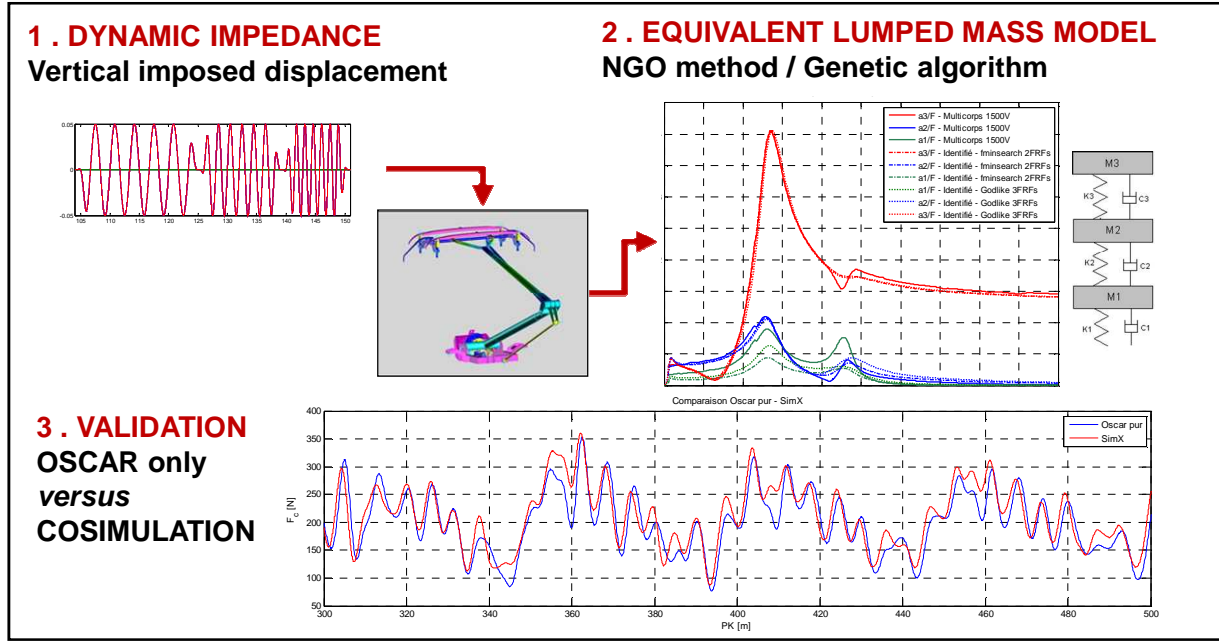

Figure 7 - Co-simulation numerical validation procedure in three steps. First, dynamic impedance calculation. Second, equivalent three lumped mass model identification. Third, temporal contact load comparison between a full OSCAR[®]/MB software co-simulation (in red) and a pure OSCAR[®] simulation using an equivalent three lumped mass model (in blue)

Statistical results confirm these observations since less than 5% matching error is found on the contact load standard deviation. As a conclusion, the co-simulation process does not introduce any significant deviations.

5. HEAD SUSPENSION OPTIMISATION BASED ON PNEUMATIC SYSTEMS

Head suspensions usually mounted on pantographs are fully mechanical systems. They ensure the dynamic uncoupling between the contact strips and the pantograph main frame, particularly above 10 Hz. They are composed of a spring box, an empty rod and ball-bearings. The schematic view is given on the left side of Figure 8.

5.1 Limits of usual mechanical head suspension

These head suspensions are designed to provide a non linear stiffness profil, but in operating conditions the working spring position is associated with a linear behaviour as illustrated on the right side of Figure 8 (the k_0 stiffness value). However, it has been shown in [10] that decreasing working suspension stiffness could lead to substantial improvements of pantograph catenary dynamical interaction. But limits arise from mechanical suspensions since decreasing the stiffness value requires an increased spring length because of preload adjustments. Thus, it has been proposed to take benefit from air supply network available on pantograph.

5.2 Passive pneumatic head suspension

The proposed innovative solution developed by SNCF^[12], is assessed using the multidisciplinary software. The design constraints are to keep the same size as the current system and use only pneumatic energy. The system is made of a passive double effect pneumatic actuator (with two chambers supplied by the same source) and two compression springs without pre-stress, as shown on the left side of Figure 9. The mean contact load is therefore

driven by the section ratio between the empty piston rod and piston head. Pneumatic damping can be controlled both by an excess flow valve and the designed piston/box clearance. The resulting stiffness behaviour is illustrated on the right side of Figure 9. One can see an ideal system with a nearly 0N/m stiffness in working position.

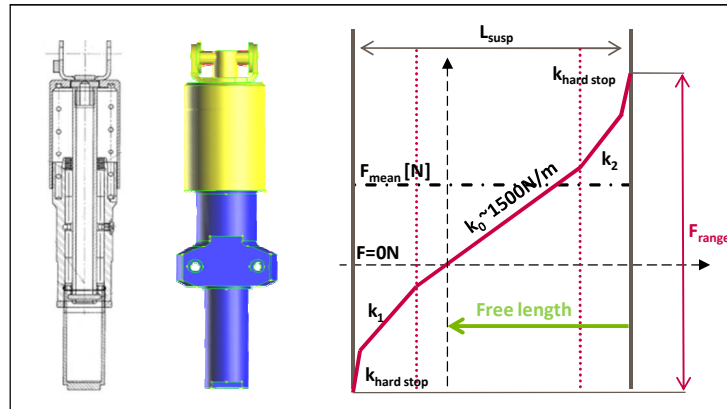

Figure 8 – Current mechanical suspension scheme (left) and its non linear stiffness (right)

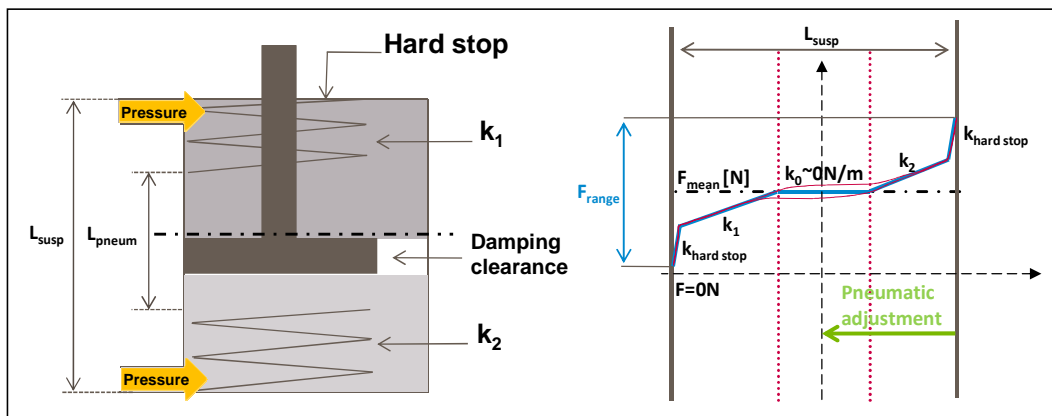

Figure 9 - Theory of the pneumatic device concept (left) and its associated non linear stiffness (right)

The pneumatic solution gives the opportunity to design a non linear stiffness with a maximum decoupling in operating conditions. The length L_{pneum} may lead to instabilities and thus is reduced to minimum. Four distinct slopes can be defined by designers: the first corresponds to the lower spring stiffness, the middle one to the operating area, the third one to the upper stiffness and the last one to the upper pneumatic actuator hard stop. The pneumatic control developed with multi-disciplinary software reproduces the expected behaviour as described on Figure 10. This detailed model highlights a hysteresis phenomenon described by red continued line on Figure 10.

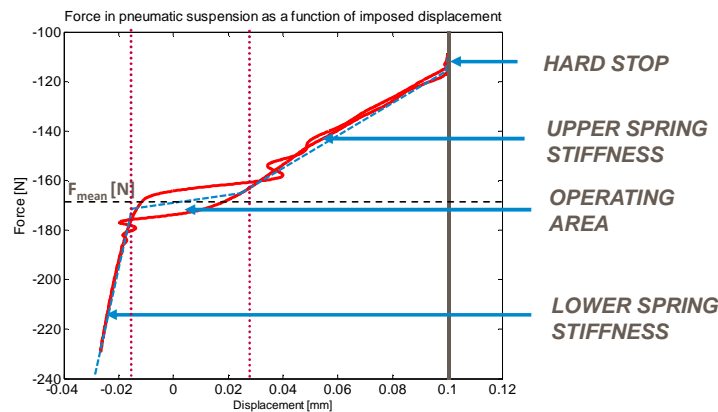

Figure 10 - Pneumatic head suspension non linear stiffness obtained by applied load simulation

5.3 Parametric analysis based on multi-disciplinary models

A parametric analysis is achieved with this co-simulation process using firstly a simplified MB three lumped mass model with two friction bands and mechanical or pneumatic head suspensions. Several simulation cases are performed then with the full MB pantograph. The catenary is the French LN2 section presented on part 2 of this paper. The post-processing simulation distance is 400m. Comparisons presented hereafter are based on a statistical contact load analysis. The mean contact load is imposed at 169N for the three lumped mass and 157N for the full pantograph model. It is carefully checked that pneumatic piston displacements remain in the operational area avoiding hard stop contact. Stiffness of springs added to pneumatic device are 10 times lower than nominal ones. The Table 1 describes the parametric comparison of pneumatic systems to the reference mechanical system (Case 1). The pneumatic system with nominal stiffness (Case 2) has a very slight impact on the head suspension dynamical behaviour (<1%). However, dividing spring stiffness by 10 (Case 3) leads to 18% decrease for standard deviation values and 21% for maximum contact load. Adding 2cm clearance (L_{pneum} , see Figure 9) doesn't improve standard deviation and increases maximum values. This parameter seems to lead to unstable behaviour. Therefore, the stiffness is the main driving parameter regarding contact load criteria.

INPUTS					OUTPUTS					
	Suspension	Stiffness $k_1=k_2$	Clearance	Bow mass	F_{mean} [N]		σ [N]		F_{max} [N]	
1	Mechanical	Nominal	-	Nominal	168.7	Ref	62.8	Ref	426.9	Ref
2	Pneumatic	Nominal	0cm	Nominal	168.7	<1%	62.1	-1%	415.9	-3%
3					168.9	<1%	51.2	-18%	336.4	-21%
4		0.1 ×Nom	2cm	Nominal	169.5	<1%	52.9	-16%	383.1	-10%
5					168.7	<1%	52.7	-16%	340.7	-20%
6					168.6	<1%	58.6	-7%	363.0	-15%

Table 1 - Contact load statistical results of a parametric analysis on pneumatic head suspension device using a three lumped mass model

Further calculations (Case 5 & 6) show the robustness of this system to additive mass of the bow. Increasing the bow mass by 50% reduces the standard deviation improvement to 7%.

This study is also done using a full flexible multibody pantograph. Results show that a large improvement of 14% is reached for standard deviation of the contact load and 17% for the maximum contact load value (see Table 2). The deviation between this full 3D MB model and the simplified three lumped mass model can be explained by accuracy differences between models, particularly above 20 Hz frequency. However, in both cases, this preliminary study is therefore very promising for future advanced design optimisation analysis.

Suspension	Stiffness $k_1=k_2$	F_{mean} [N]	σ [N]	F_{max} [N]
Mechanical	Nominal	155	63.2	413
Pneumatic	0.1 ×Nom	150	54.7	341
Relative difference [%]		-3%	-14%	-17%

Table 2 - Statistical results for a comparison between mechanical and pneumatic actuator mounted on full flexible MB pantograph

6. REPRODUCING RAILWAY SWITCH

6.1 Pantograph and railway switch definition

Risky area modelling aims at identifying pantograph catenary adjustment that could lead to system breakage, especially when a CW coming from pantograph side impacts the lateral horn with a critical inclination. This study is based on a French High Speed pantograph composed of two independent contact strips (see Figure 11) in the case of a railway switch passing.

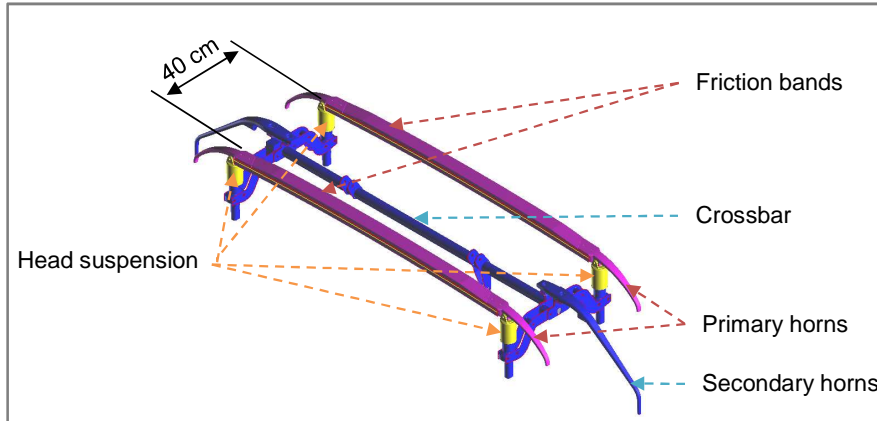

Figure 11 - Full multibody pantograph bow description with two independent contact strips

The railway switch is characterised by a “main track” that encounters a “secondary track” at a “crossing point”. The “main track” is the current train running line. The secondary track comes from pantograph side and impacts the bow at the “landing point” as detailed on the Figure 12. The height and the lateral position of the landing point on the pantograph horns is particularly critical because it can occur below the horn according to the horizontal and vertical CW incident angle. Those parameters are defined by national maintenance rules. Usually, no crash happens because lateral horns are designed to guide CW on friction bands. However, some particular configurations allow crash situations illustrated by the Figure 12.

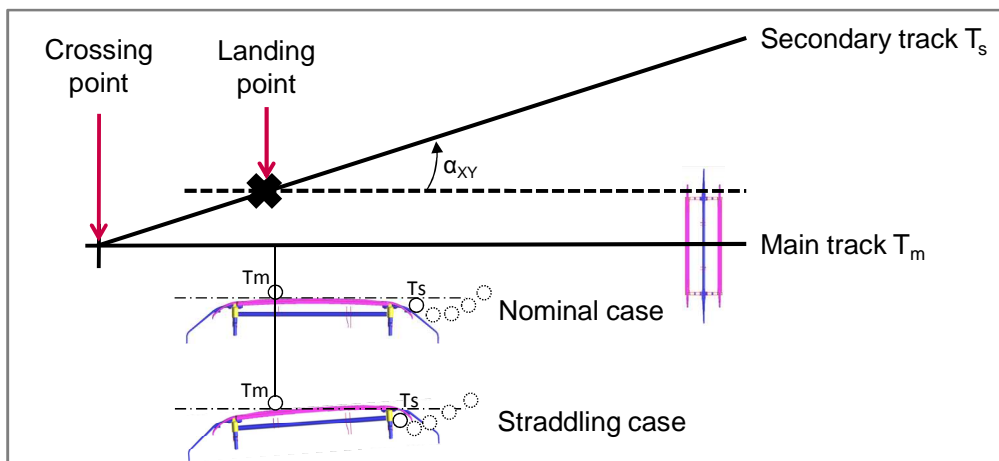

Figure 12 - Description of the railway switch and the pantograph bow straddling phenomenon

6.2 Multibody modelling and co-simulation process

The methodology described hereafter aims at studying the critical railway switch configurations whatever considered train line. The CW of the main track applies a vertical load on the bow leading to a slight inclination of the friction bands and, as a result, a slight displacement of the primary horn extremity. Moreover, the bow suspension preload is considered to vertically position the two friction bands. According to the studied catenary, limit inclination angles for the CW of the secondary track in XY and XZ plans can be defined.

The railway switch is modelled using both MB and OSCAR[®] software. A rigid CW is positioned over the friction bands to model the main track within the MB software. It applies a static load on friction bands according to pressure value defined in pneumatic actuator. For this analysis, the static load is adjusted to 80N and the train is running at 30km/h. The CW of the secondary track is modelled within OSCAR[®] and composed by a simple FE pre-tensioned wire. The incident angles of this CW are parameterized as well as the landing point position. Three communication entities are modelled in the MB software for co-simulation process and the displacements are controlled by OSCAR[®]. The contact with friction bands and lateral horn is managed by the MB software. The modelling result is graphically shown on Figure 13.

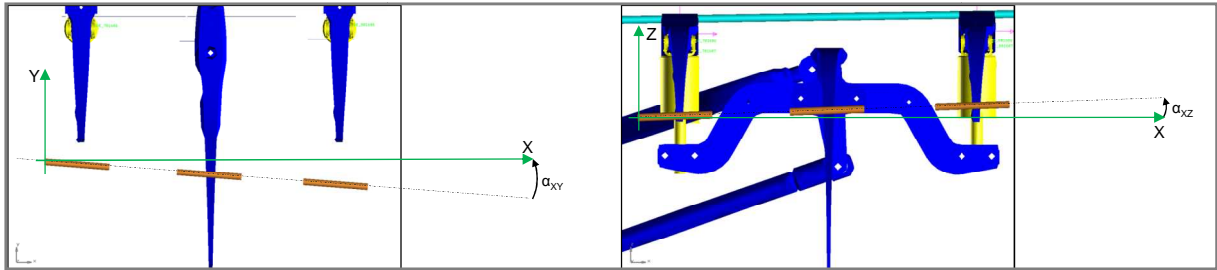

Figure 13 - Railway switch modelling through a co-simulation process based on full MB pantograph and OSCAR[®] FE catenary. Left: Incident angle on XY plan - Right: Incident angle on the XZ plan

6.3 Simulation results and discussion

The first modelling case corresponds to a vertical 2° and horizontal 7.5° inclinations of the secondary CW. These values are considered to be representative of railway switch incident angles. The main CW is static, rigid and positioned at a distance of -0.31m from the friction band center. For a completely rigid pantograph as well as for a partially flexible one, the secondary CW is guided by the lateral horns until the top of the friction bands.

In a second time, the inclination angles are adjusted until limit values corresponding to the minimum incident angles that could allow horn straddling considering this specific pantograph catenary configuration. The results of those two cases are shown on the Figure 14. On the left is displayed the case of a partially flexible model where the secondary CW is normally guided. One can see the deformation of the upper arm and rod as well as the lateral horn. On the right, the same model is used with critical incident angles. The impact pushes down the crossing bar and, as a consequence, increases the clearance between the bottom point of primary horn and the contact point on the secondary horn reaching a maximum value closely to the straddling time. The lateral wire is slightly sliding below the primary horn and then comes below the friction band. It would have lead to system breakage in a real case on track. Several other parameters could be considered to complete this analysis. Head suspension preloads, car body inclination and vertical movements, pantograph catenary dynamics induced by the main CW and its lateral positioning etc. These additional parameters could be taken into account to perform a parametric analysis and lead to a precise definition of potentially critical situations linked with pantograph catenary defects and find failure causes.

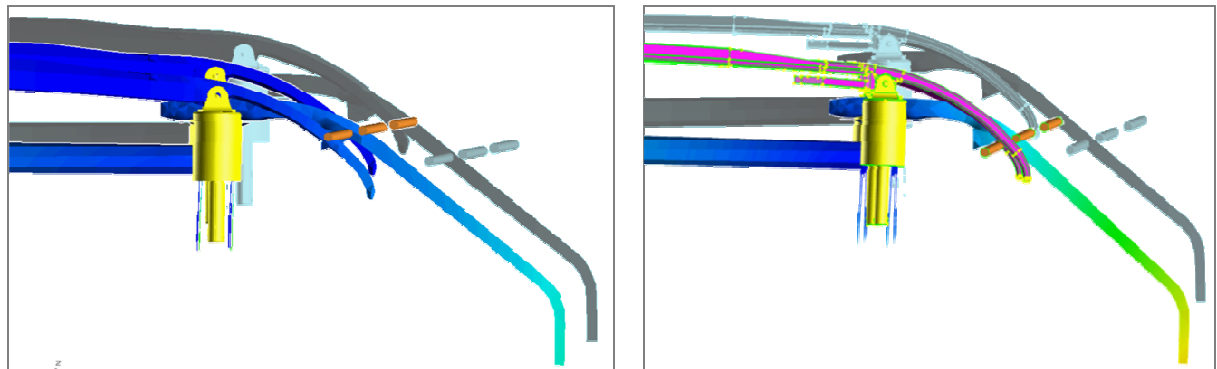

Figure 14 - Left: Secondary CW is guided by the lateral horns over the friction bands - Right: Secondary CW is going to impact the bottom part of the primary front horn leading to straddling effect

7. CONCLUSION

This paper presents recent developments undertaken in the framework of SNCF Innovation & Research Department projects on pantograph catenary interaction modelling based on advanced multibody and finite element simulation tools. This powerful approach that combines multi-physic computing strategies is an answer to growing needs for detailed pantograph catenary analyses reproducing realistic physical behaviour and giving access to a large range of parameters hardly measurable on track or test bench.

The numerical tools are firstly described and are composed by a finite element catenary modelling using the SNCF OSCAR[®] software and a multi-disciplinary pantograph modelling based on an advanced multibody software including finite element and control system methodologies. Thus, a complete flexible multibody model of a French high speed line pantograph from a three dimensional CAD geometry is presented. The main physical properties of

the mechanical system are reproduced such as bodies flexibility for structural modal deformation using Craig-Bampton reduction method, pneumatic control for pantograph base actuation system and kinematic definition for large displacements and mechanical non-linearities.

The two software are coupled through a co-simulation procedure giving the opportunity to perform various kinds of pantograph catenary operational cases since the technology developed includes specific pantograph adjustment capabilities and data exchange options to ease parametric studies achievement and post-processing. The global co-simulation process is described from the creation of communication entities to the time dynamic calculation. A focus is made on the iterative fixed time step procedure with a computer memory based data exchange. The method is assessed and demonstrates a high agreement with a pure OSCAR[®] simulation using an equivalent three lumped mass model.

The application fields allowed by this numerical approach are extended to new and more complex kinds of engineering studies involving the pantograph system at a very detailed level. A design optimisation process firstly illustrates the possible improvements that can be foreseen using an innovative pneumatic head suspension. The parametric study describes gains obtained from mechanical and pneumatic aspects separately and defines limits in terms of acceptable mass on board. Secondly, railway switches are studied to define critical catenary design and pantograph adjustment parameters that could lead to system breakage according to body flexibility and suspension preload of the pantograph. Results show that three dimensional structural consideration is crucial for this kind of expertise.

Those first results demonstrate the power of these enhanced finite element and multibody co-simulation tool that could be used to produce large scale optimisations based on experimental design that will represent a precious support for future pantograph catenary developments.

Acknowledgements

This paper describes work undertaken by SNCF Research and Innovation Department with the precious support of SNCF Infrastructure and Rolling Stock Engineering Departments as well as MSC Software, SDTools and Vibratéc companies. The Authors would like to particularly thank Thierry BERNARD from MSC Software for his contribution on pantograph multi-disciplinary modelling and co-simulation process development.

References

- [1] DUPUIS H., MASSAT J. -P., LAURENT C., *Pantograph modelling for the optimization of its dynamical behaviour*, In Proceedings of the World Congress on Railway Research, 2011.
- [2] CLEON L. -M., BOBILLOT A., MENDEL J. -P., AZIZ E.: *OSCAR: La caténaire en 3D*, In Revue Générale des Chemins de Fer, Volume n° 155, 2006.
- [3] MASSAT J. -P., LAINE J. -P., BOBILLOT A.: *Pantograph-catenary dynamic simulation*, In Proceedings of the International Association for Vehicle System Dynamics, 2004.
- [4] MASSAT J. -P.: *Modélisation du comportement dynamique du couple pantographe-caténaire, Application à la détection de défauts dans la caténaire*, In doctoral thesis, 2007.
- [5] EN50318:2002: *Railway applications. Current collection systems. Validation of simulation of the dynamic interaction between pantograph and overhead contact line*, European standard, 2002.
- [6] GRASES RAUTER F.: *Pantograph-catenary interaction using flexible multibody dynamics methodology*, In doctoral thesis, 2011
- [7] MASSAT J.-P., LAURENT C.: *Simulation Tools for Virtual Homologation of Pantographs*, In proceedings of the First International Conference on Railway Technology (Railways 2012), 2012.
- [8] BALMES E., BIANCHI J. -P., MASSAT J. -P.: *OSCAR 1.0 user's guide*, Internal report, 2011.
- [9] BOBILLOT A., CLEON L. -M., COLLINA A., MOHAMED O., GHIDORZI R.: *Pantograph-Catenary: a High-Speed European couple*, In Proceedings of the World Congress on Railway Research, 2008.
- [10] BOBILLOT A., MASSAT J. -P., MENDEL J. -P.: *Design of pantograph-catenary by simulations*, In proceedings of the World Congress on Railway Research, 2011.
- [11] TEPPE S., CLERC C., BOBILLOT A., GRASES RAUTER F.: *Modélisation du comportement dynamique d'un pantographe*, In Proceedings of the MSC Software Adams Users Group Congress, 2010.
- [12] MASSAT J. -P.: *Pantograph for a railway vehicle*, Patent PCT/EP2012/057017, 2012.