



### **Science Arts & Métiers (SAM)**

is an open access repository that collects the work of Arts et Métiers Institute of Technology researchers and makes it freely available over the web where possible.

This is an author-deposited version published in: <https://sam.ensam.eu>  
Handle ID: <http://hdl.handle.net/10985/9178>

#### **To cite this version :**

Benjamin LAMOUREUX, Jean-Rémi MASSÉ, Nazih MECBAL - Selection and Validation of Health Indicators in Prognostics and Health Management System Design - In: Conference on Control and Fault-Tolerant Systems (SysTol), 2013, France, 2013-10 - SysTol 2013 - 2013

Any correspondence concerning this service should be sent to the repository

Administrator : [scienceouverte@ensam.eu](mailto:scienceouverte@ensam.eu)



# Selection and Validation of Health Indicators in Prognostics and Health Management System Design

Benjamin Lamoureux, Nazih Mechbal, and Jean-Rémi Massé

**Abstract**— Health Monitoring is the science of system health status evaluation. In the modern industrial world, it is getting more and more importance because it is a powerful tool to increase systems dependability. It is based on the observation of some variables extracted in operation reflecting the condition of a system. The quality of health monitoring strongly depends on the selection of these variables named health indicators. However, the issue in their selection is often underestimated and their validation is, of what is known, an untreated subject. In this paper, the authors introduce a complete methodology for the selection and validation of health indicators in health monitoring systems design. Although it can be applied either downstream on real measured data or upstream on simulated data, the true interest of the method is in the latter application. Indeed, a model-based validation can be integrated in the design phases of the system development process, thereby reducing potential controller retrofit costs and useless data storage. In order to simulate the distribution of health indicators, a well known surrogate model called Kriging is utilized. Eventually, the method is tested on a benchmark system: the high pressure pump of aircraft engines fuel systems. Thanks to the method, the set of health indicators was validated in system design phases and the monitoring is now ready to be implemented for in-service operation.

## I. INTRODUCTION

The end of the last century witnessed a turning point in the history of science: the appearance of computational science. Over the last decades, the computational capabilities increased such that it became possible to simulate the most complex problems like flow around a wing or gas diffusion in the atmosphere. Nowadays, we are in the era of what some call e-science of data-centric science, combining experience-based, theoretical and computational sciences to maximize the amount of knowledge available.

This easy access to knowledge has allowed the rapid development of new disciplines based on systems behavioral knowledge. Thus, dependability was introduced in the early 1980s by Laprie [1] in order to encompass reliability, safety, security, maintainability and integrity and has continually gained importance to be elevated to the rank of strategic challenge for many industries, particularly in the fields of transportation and energy. Dependability can be divided into three components, namely attributes, threats and means. In

Benjamin Lamoureux is a PhD student with both the PIMM laboratory of Arts & Métiers ParisTech and the R&D department of SAFRAN Snecma (phone: +33688187030; e-mail: benjamin.lamoureux@sneema.fr).

Nazih Mechbal is with the PIMM laboratory of Arts & Métiers ParisTech, 75013 Paris, France (e-mail: nazih.mechbal@ensam.eu).

Jean-Rémi Massé is a SAFRAN Snecma senior expert in systems reliability, prognostics and health monitoring, 77550 Réau, France (e-mail: jean-remi.masse@sneema.fr).

this paper, the focus is on the means, and more precisely the use of Prognostics and Health Management (PHM) to increase dependability.

PHM was originally developed for structural applications under the name Structural Health Monitoring (SHM) [2]. It was defined as a way to perform fault detection and fault identification of a given system. Afterwards, it has expanded to other fields and has been supplemented by a prognostic function, aimed at predicting the evolution of a system health condition. Eventually, a supervision aspect was added to complete the PHM scheme [3]. The purpose of supervision is to link monitoring to maintenance in order to act effectively on dependability. The global scheme of interactions between system, PHM and Maintenance is presented in Fig. 1 where MRO means Maintenance, Repair and Overhaul. Nowadays, PHM is of paramount importance with the widespread use of contracts based on the operating time. It is even becoming a selling point for dependability dependent industries such as aircraft engine manufacturers.

As most of the processes, the quality of PHM is strongly dependent on its input data. In this case, input data are some variables extracted in operation reflecting the condition of the system and named Health Indicators (HI). They are the keystone of PHM: a good selection of HIs in the upstream stages ensures good PHM performances downstream. The most important feature for a good set of HI is to be defined before the system enters into service in order to reduce the retrofit costs, which can be prohibitive for example in cases where the controller is subject to stringent certifications. This implies that the HIs must be validated within the design phases of the system. However, this early validation is not possible in the actual PHM development process because the amount of knowledge at this point is generally not sufficient to overcome the stochastic nature of the HIs behavior.

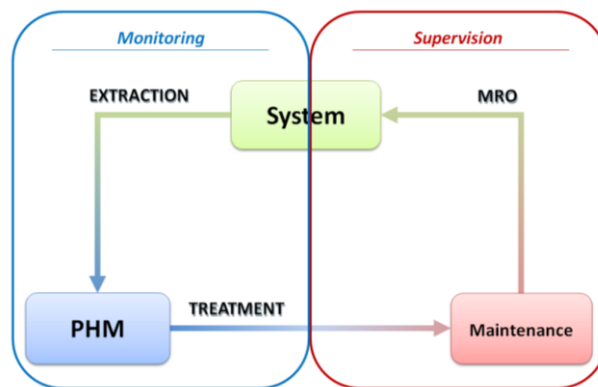

Figure 1: Interactions between system, PHM and Maintenance

Thus, the issue of the selection and validation of HIs encounters two types of problems: on the one hand a methodological one as the validation of HIs before their implementation is not integrated in the PHM system design process and on the other hand a technological one as not enough measured data is available in the design phases for the validation itself. Despite the prominence of HIs, these two issues are rarely addressed in the scientific community. Concerning the selection aspect, we can cite the method of parity space [4] to create residuals with good properties but although performing well for academic examples, it faces the following issues as soon as real life complex systems are considered: sensors quality, environmental uncertainties, manufacturing variability and low computational capabilities, to give a short list. Concerning the validation aspect, it is, of what is known, an untreated subject. Since the problem is twofold, it is the same for the contribution of this paper:

Firstly, the authors introduce a new PHM development process aiming at integrating the construction of HIs in the design phases of the system. This new methodology is called IPHM for Integrated PHM. The selection and validation of the HIs is based on the computation of Numerical Key Performance Indicators, presented in section III.

Secondly, the authors introduce a numerical method for the validation of HIs. It is based on the combination of physical modeling and uncertainties propagation in order to create a database of healthy and faulty distributions of HIs. Moreover, as the models are time-demanding, a well-know surrogate modeling technics called Kriging inherited from geostatistics is introduced. Its purpose is to build a low cost estimator of the model outputs. Finally, the whole scheme is applied to select and validate a set of HI for the PHM of an aircraft engine high pressure gear pump.

## II. SELECTION AND VALIDATION OF HEALTH INDICATORS

In this section, the authors introduce a new development process aiming at integrating the selection and validation of HIs. This new development process is called Integrated Prognostics and Health Management (**IPHM**).

### A. Integrated Prognostics and Health Management

The most common software development scheme is the V-model. The principle of IPHM is to divide the V-model of the PHM system into two Vs for respectively the monitoring and the supervision parts. The new scheme, presented in Fig. 2, is called V2-model. The main features of this model are the presence of a virtual implementation, a two-steps Verification and Validation (**V&V**) and a maturation phase [5]. In this paper, the focus is on the virtual implementation and the monitoring process validation as the rest of the method will be treated separately in other works.

### B. Health Indicators Selection

The selection of HIs consists in defining what are the variables of interest, how they are constructed and how often then are recorded. It is based on a complete system analysis performed from different levels of knowledge available in design phases. The purpose of this analysis is to determine the following elements:

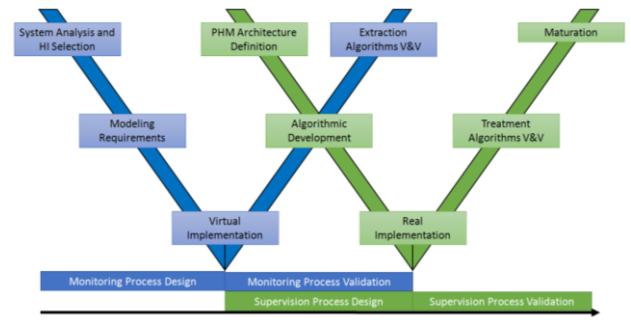

Figure 2: V2-model scheme

- **Failure modes:** a failure is characterized by a non-functional state of the system
- **Degradation modes:** a degradation is characterized by a functional but non-healthy state of the system. The Maximal Admissible Magnitude (**MAM**) of a degradation mode is the magnitude for which the failure state is reached with a probability of 0.5.
- **Uncertainties:** parameters subject to uncertainties and the form of their uncertainty

Generally, the failure modes can be deduced from the equipment specifications. The degradation modes are often more difficult to determine as their observation is rare. They principally rely on expert judgments or experience feedback from similar systems. Finally, the most complex step of the system analysis is to manage uncertainties because there are generally a large number of sources of uncertainties for a small amount of knowledge. It is common to use sensitivity analysis technics to reduce the number of uncertain parameters and focus the uncertainties quantification efforts on the most influent ones. At the end, the ideal is to have a Probability Density Function (**PDF**) for all the sources of uncertainties.

### C. Health Indicators Validation

The validation of HIs consists in quantifying the quality of the set of HIs for detection, identification and prognostics. In this document, focus is on detection and identification, since our studies on prognostics are still in their infancy. A good set of HI should have the following characteristics:

- Each HI should detect at least one degradation mode within the specified performances
- The set of HI should detect all the degradation modes
- The set of HI should identify and localize all the degradation modes
- On-line HI extraction should have a low time of computation
- On-line HI recording should have a low storage cost
- The set of HI should be defined before the system entry into service

In order to evaluate the performances following these axes, the authors have defined some indices called Key Performance Indicators (KPI), an acronym quite common in the industry. In our application, as these KPI are computed before the commissioning of the system, based on numerical simulations, we call them NKPI for Numerical KPI. These NKPI are introduced in the next section.

### III. NUMERICAL KEY PERFORMANCE INDICATORS

In signal detection theory [6], a classical indicator of the performance of a binary classifier system is the Receiver Operating Characteristic curve or ROC curve. It is a graphical tool representing the True Positive Rate (TPR) or number of good detections versus the False Positive Rate (FPR) or number of false alarm for a large range of thresholds. The authors have defined some NKPI from this ROC curves. In this section, it is supposed that the following data are available (from measures or simulations):

- The PDF of each HI  $i$  in healthy state:  $\eta_i^0$
- The PDF of each HI  $i$  for each degradation mode  $j$  in MAM state  $\eta_i^j$

#### A. Detection NKPI

Two different NKPI are defined from the ROC curve [7] between  $\eta_i^0$  and  $\eta_i^j$ :

Global Detectability (GD) quantifies the potential of HI  $i$  to detect degradation mode  $j$ . Its values range from 0 to 1. It is defined as the Gini coefficient [8] of the ROC curve:

$$GD(\eta_i^0, \eta_i^j) = 2 \times AUC(ROC(\eta_i^0, \eta_i^j)) - 1 \quad (1)$$

where AUC means Area Under The Curve.

Compliant Detectability (CD) is a Boolean indicating if the HI  $i$  is able to detect degradation mode  $j$  in compliance with detection specifications. In the industry, these specifications are commonly expressed in terms of maximal FPR and minimal TPR. The CD is defined as following:

$$CD(\eta_i^0, \eta_i^j) = \begin{cases} 1 & \text{if } ROC(\eta_i^0, \eta_i^j) \text{ above CP} \\ 0 & \text{if } ROC(\eta_i^0, \eta_i^j) \text{ under CP} \end{cases} \quad (2)$$

where CP is the compliance point defined as the point with coordinates  $(FPR_{spec}, TPR_{spec})$ , with  $FPR_{spec}$  the specified maximal FPR and  $TPR_{spec}$  the specified minimal TPR. Fig. 3 presents the ROC curve and the CP for  $FPR_{spec} = 5\%$  and  $TPR_{spec} = 80\%$  between two Gaussian distributions of respective parameters  $\theta_1 = (0,1)$  and  $\theta_2 = (3,2)$ .

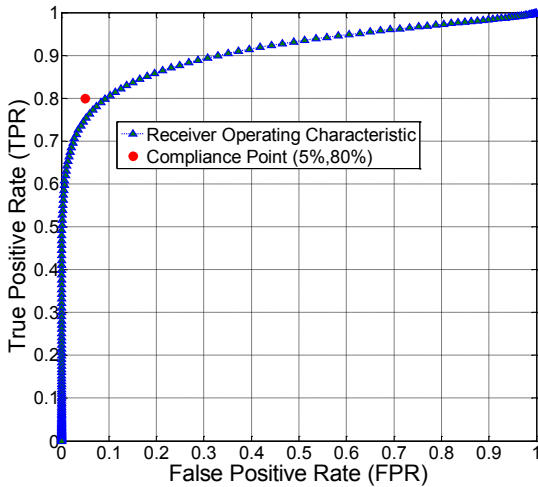

Figure 3: Example of ROC curve with Compliance Point (5%,80%)

#### B. Identification NKPI

To introduce the identification NKPI, it is necessary to define the signatures: a signature  $Sgn^j$  of a degradation mode  $j$  is defined as the vector of the GD values multiplied by the direction of the average variation for the whole set of HIs. The signature vectors values range from -1 to 1:

$$\begin{cases} Sgn^j = (A_1^j, \dots, A_h^j)^T \\ A_i^j = sign[\mu(\eta_i^j) - \mu(\eta_i^0)]GD(\eta_i^0, \eta_i^j) \end{cases} \quad (3)$$

where  $h$  is the number of HIs and  $\mu(\cdot)$  is the operator calculating the mean of a distribution.

Assuming that the set of HIs is a Euclidian vector space, the identification NKPI called Distinguishability ( $Dis$ ) can be defined as the angle between two signature vectors:

$$Dis(Sgn^j, Sgn^k) = \text{acos}\left(\frac{Sgn^{jT} Sgn^k}{\|Sgn^j\| \|Sgn^k\|}\right) \quad (4)$$

where  $\text{acos}(\cdot)$  is the arccosine function and  $\|\cdot\|$  is the norm.

#### C. Extraction Costs NKPI

The authors have chosen to define two extraction costs NKPI; one to traduce the on-line computation cost (CC) and one to traduce the on-line storage cost (SC) of HIs. The CC is defined as the number of CPU operations dedicated to the extraction of HIs during one sampling period and the SC is defined as the number of octets utilized for the storage of HIs between two downloads of the data to the supervision station.

### IV. SURROGATE MODELING FOR NUMERICAL VALIDATION

#### A. Surrogate Modeling Principle

When physics based models are time-demanding, performing a propagation of uncertainties is too expensive. For example, let's consider a model whose simulation time is about one hour on an average desktop computer. Let's also suppose that there is only one degradation mode and only one HI. If we use a Monte-Carlo simulation (MCS) of 2000 runs for uncertainties propagations, it will take about 3 months to compute only the healthy and one faulty distribution. So when real life systems are considered, with tens or hundreds of degradation modes and HIs, it becomes a Herculean task.

In order to overcome this problem, it is necessary to use surrogate modeling, also called metamodel or emulator, which is a kind of "low cost" model of model. For example, surrogate modeling is used to optimize aerospace design [9] because the simulation of the airflow around the wing profiles is highly time-demanding. A surrogate model is defined as a mathematic function of negligible computation cost approximating the physics based model responses. Building a surrogate model is done by following these steps:

- Determination of the variation range of influential parameters and their PDF. This step derives directly from uncertainties quantification.
- Choice of the surrogate model type
- Initial design of experiment (DoE) for learning sites.
- Scatter plot of the learning sample (Visual Checking)
- Surrogate model construction as presented in Fig. 4.

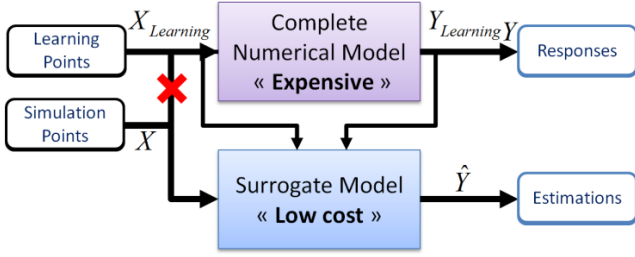

Figure 4: Principle of surrogate modeling

There are many types of surrogate models described in literature. We can cite for example linear regression, chaos polynomials, neural networks or more recently support vector regression. In this document, the focus is on Kriging.

### B. Basics of Kriging

Originally, Kriging, also called Gaussian process, was developed by the mining engineer Daniel Krige for interpolation in geostatistics before being applied to numerical modeling. See [10] for a recent survey. A Kriging model can be written as following:

$$Y(\mathbf{x}) = \mathbf{f}^T(\mathbf{x})\mathbf{b} + Z(\mathbf{x}) \quad (5)$$

where  $\mathbf{x}$  is a point in a  $d$ -dimensional input space,  $\mathbf{f}^T(\mathbf{x})\mathbf{b}$  is a regression model and  $Z$  is a Gaussian process of mean zero and covariance  $\sigma^2\mathcal{R}(\theta, \mathbf{x}_i, \mathbf{x}_j)$  with  $\mathcal{R}$  an assumed correlation function between outputs and inputs. As it is not the main purpose of this paper, we will not enter in the details of Kriging modeling. We highlight the fact that the Kriging model depends on hyperparameters  $\theta, \mathbf{b}$  and  $\sigma^2$  which are generally estimated by maximum likelihood. The choice of Kriging as a surrogate model has been motivated by its following characteristics:

- It is a Best Linear Unbiased Predictor (**BLUP**)
- It is an exact interpolator on learning sites
- It is capable of estimating its own prediction variance

A Kriging toolbox available for the software Matlab© is introduced in [11]. This toolbox proposes an algorithm for the estimation of the Kriging hyperparameters which will be used in the following application.

### C. Kriging Validation

Despite its good characteristics mentioned above, the main drawback of Kriging is the uncertainty derived from the estimation of its hyperparameters which can lead to aberrant results. Consequently, it is necessary to use some validation criteria. For example, a criterion based on cross validation can be used. The cross validation is based on the computation of the surrogate model prediction error  $e_{-i}$ :

$$e_{-i} = f_i - \tilde{f}_{-i} \quad (6)$$

where  $f_i$  is the exact output value of design point  $i$  and  $\tilde{f}_{-i}$  is the prediction given by the Kriging metamodel learnt without design point  $i$ .

Then, the cross validation curve is defined as the curve of  $\tilde{f}_{-i}$  versus  $f_i$ . The closer to the curve  $\tilde{f}_{-i} = f_i$  the scatterplot, the more efficient the Kriging model. In this paper, we use the cross-validation curve to validate the Kriging model.

## V. APPLICATION: SELECTION OF HEALTH INDICATORS AND SYSTEM MODELING

### A. System Analysis

The studied system is the main fuel pump (**MFP**) of an aircraft engine fuel system. It is a gear pump whose function is to supply the fuel flow to the fuel metering unit. As the whole fuel injection depends on the MFP, it is a critical equipment. Thanks to experience feedback and expertise, it has been possible to determine both the failure mode and the degradation mode of this system:

- **Failure mode:** the specification of the system gives a minimum HPP outlet fuel flow  $Q_{min}$  at ten percent of its nominal rotation speed  $\omega_{10\%}$ .
- **Degradation mode:** for this application, only one degradation mode was retained: the internal leakage.

We limit the study to the starting sequence, when the aircraft is still on ground and the environmental variability is reduced. Thus, there are four sources of uncertainties whose quantification is performed via experience feedback from others similar types of engines:

- **Fuel temperature:**  $T_{fuel}$  modeled by a generalized extreme values (**GEV**) PDF  $\mathcal{G}\mathcal{E}\mathcal{V}(2, 0.1)$
- **Low pressure fuel pump (LPP) supply pressure:**  $P_{LP}$  modeled by a Gaussian PDF  $\mathcal{N}(2, 0.01)$
- **Injection pressure:**  $P_{inj}$  modeled by a Gaussian PDF  $\mathcal{N}(1, 1e^{-4})$
- **Pump displacement:**  $Dis$  modeled by a Uniform PDF  $\mathcal{U}(2.34e^{-5}, 1e^{-7})$

### B. System Modeling

Some related works on the subject have addressed the issue of modeling a gear pump and its degradation modes, for example [13]. In this paper, the model is built with the software AMESim®, based on the Bond Graph theory. The pump outlet flow is expressed as:

$$Q = \alpha \cdot \eta_v \cdot Dis \cdot \omega \quad (7)$$

where  $Dis$  is the pump displacement,  $\eta_v$  the volumetric efficiency and  $\alpha$  an empirical constant. The equation used to compute the volumetric efficiency is:

$$\eta_v = 1 - \left\{ \left[ 1 - \left( \beta - \frac{\gamma \cdot \Delta P}{\omega} \right) \right] \cdot \left[ 1 + \delta \cdot \frac{T_{fuel}}{\omega} \right] \right\} \quad (8)$$

where  $\Delta P$  is the pressure drop between pump inlet and pump outlet and  $\beta, \gamma, \delta$  are empirical constant values. We simulate the internal leakage by adding a diaphragm between pump outlet and pump inlet of section  $S_{leak}$ .

Finally,  $Q$  can be expressed as a function  $\mathcal{f}$  of  $\omega, Dis, \Delta P, T_{fuel}$  and the section of the MFP internal leakage  $S_{leak}$ . If  $Dis, \Delta P$  and  $T_{fuel}$  are random variables, we define the MAM of the internal leakage as the value of  $S_{leak}$  for which  $\mathcal{f}(\omega_{10\%}, Dis, \Delta P, T_{fuel}, S_{leak})$  is lower than  $Q_{min}$  with a probability of 0.5. In our application, the MAM is  $1.76 \text{ mm}^2$ .

### C. Health Indicators

Because the system has no flow sensor, it is not possible to perform a direct monitoring of the failure level. Therefore, an indirect observation via health indicators is needed. The idea is to build HIs which are images of the hydraulic power gradient over the starting sequence. To do this, we expand the studied system to the following ancillary valves, schematized in Fig.5.

- **BSV**: Burning Stage Valve to switch between 1 and 2 injector lines.
- **TBV**: Transient Bleed Valve to produce a discharge in the high-pressure compressor when needed.
- **HPSOV**: High Pressure Shut Off Valve to maintain the pressurization of the system and turn on or shut off the fuel injection.

Then we construct three HIs corresponding to the pump rotation speed at the opening the BSV, the TBV and the HPSOV named respectively  $w_{BSV}$ ,  $w_{TBV}$  and  $w_{HPSOV}$ .

### D. Kriging Model

Even if the physics-based model built with AMESim is not so time-demanding; one simulation is about 1 minute long, we still use a Kriging model for this application as an example to validate general case. The model is defined by a vector of five inputs  $x$ :

$$x = [Dis \quad P_{LP} \quad P_{inj} \quad T_{fuel} \quad S_{leak}]^T \quad (9)$$

For the learning DoE, we use a uniform Latin hypercube sample of 200 points where the variation boundaries of all the inputs are the 1% quantile and the 99% quantile except for  $S_{leak}$  for which the variation range is  $[0; 1.76]$ . We then choose a zero order regression model and an exponential-Gaussian correlation model and use the DACE algorithm to estimate the Kriging hyperparameters.

In order to validate the Kriging model, we draw the cross-correlation curve. Fig.6 shows that cross-correlation curve for HI  $w_{BSV}$ . We can see that the different points are well grouped around the linear regression curve so for this HI, we consider that the Kriging model is accurate enough. Same validation is made for the other HIs.

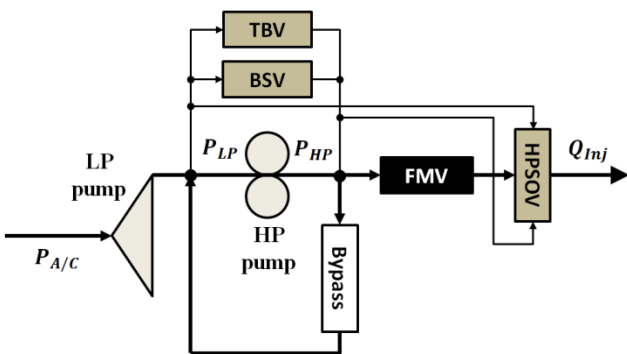

Figure 5: Complete system with ancillary valves where FMV means Fuel Metering Valve

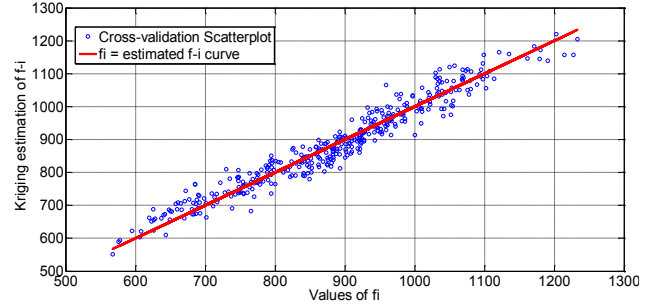

Figure 6: Cross-correlation curve for  $w_{BSV}$

## VI. APPLICATION: VALIDATION OF HEALTH INDICATORS

### A. Uncertainties Propagation

We use Monte-Carlo simulations (MCS) to propagate uncertainties into the Kriging model. Our objective is to compute  $\eta_i^0$  and  $\eta_i^j$ . In our application, as we have three HIs and one degradation mode,  $i \in \llbracket 1; 3 \rrbracket$  and  $j = 1$ . Thus, we compute six distributions. We recall that  $\eta_i^1$  is computed for the MAM of the degradation mode, i.e. for a leakage section of  $1.76 \text{ mm}^2$ . For each distribution, the MCS is performed on 2000 runs.

### B. Health Indicators Distributions

The distributions of  $\eta_i^0$  and  $\eta_i^1$  for the three HIs computed from MCS are shown in Fig.7. It can be noticed that if the distributions seem to be well separated for  $w_{TBV}$  and  $w_{HPSOV}$ , the overlapping is rather important for  $w_{BSV}$ . This suggests that the choice of this latter HI is inappropriate whereas the others are efficient. To verify these assumptions, we compute the NKPIs.

### C. NKPI Computation

Since there is only one degradation mode in this example, identification NKPIs has no sense so we compute only detection NKPI. We compute both global detectability and compliant detectability for compliance point (0.05,0.8), the common values used in the field of aeronautics. The results are given in Table I. From this table, we can extract four major characteristics of the selected set of HIs:

- $w_{BSV}$  is not a good HI since its CD is equal to zero. Thus, we can remove this HI from the set.
- $w_{TBV}$  and  $w_{HPSOV}$  are both efficient to detect the degradation mode within required performances so the HI set will be robust to the loss of one of them.
- $w_{TBV}$  and  $w_{HPSOV}$  have a high GD: their detection capability will be robust to changes in specifications.
- All the HIs have good Computation Cost NKPI.

TABLE I. DETECTION NKPIs

HI	Global Detectability	Compliant Detectability	on-line computation cost	on-line storage cost
$w_{BSV}$	0.83	0	~3 flops	~1 ko
$w_{TBV}$	0.99	1	~3 flops	~1 ko
$w_{HPSOV}$	1	1	~3 flops	~1 ko

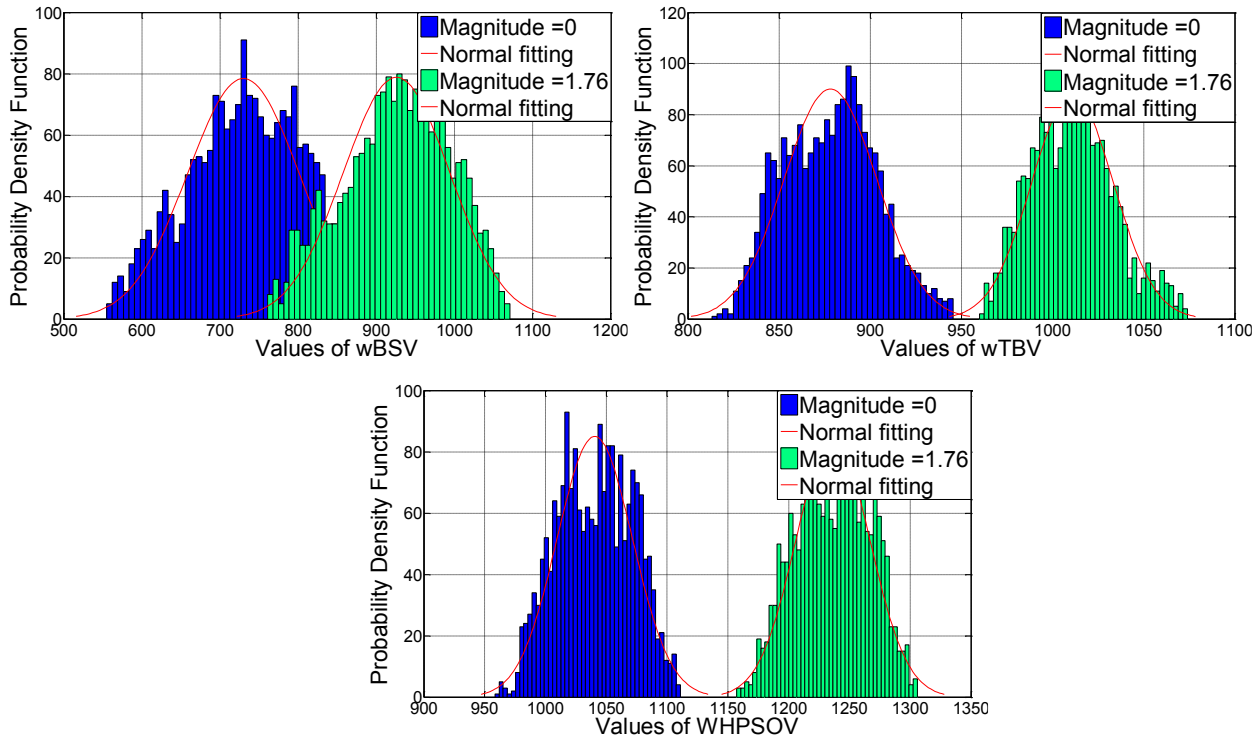

Figure 7: Distributions computed from Monte-Carlo Simulations for  $w_{BSV}$  (top-left),  $w_{TBV}$  (top-right) and  $w_{HPSOV}$  (bottom)

## VII. CONCLUSION

In this paper, the authors have introduced a new method to develop prognostics and health management system. This new method, called integrated prognostics and health management is based on the use of numerical modeling and uncertainties propagation to generate data in sufficient amount to validate health indicators. As the uncertainties propagation is highly time-demanding, we propose to use a Kriging model as an emulator to reduce its computation costs. The advantage of the method is that it is applicable in the upstream system design phases, which avoids useless on-line storage and limits retrofit costs. The authors have also defined some numerical key performance indicators as criterion to perform the validation of health indicators.

The method has eventually been applied to the validation of health indicators aimed at monitoring the high pressure pump of aircraft engines fuel systems. It shows encouraging results to select efficient health indicators and determine their robustness. For future prospects, the objective is to apply this method to the whole aircraft engine fuel system, composed of many subsystems and modeled by a large number of inputs and parameters. For the time being, our mastery of the Kriging modeling is not sufficient to have an accurate enough emulator for such dimensions. Thus, our research efforts will be dedicated to the improvement of Kriging accuracy. Three axes are considered: the use of sensitivity analysis technics to simplify inputs, intelligent adjustment of hyperparameters and sequential learning.

## REFERENCES

- [1] J. C. Laprie, "Dependable computing and fault-tolerance," in *Digest of Papers FTCS-15*, 1985, pp. 2-11.
- [2] K. Diamanti and C. Soutis, "Structural health monitoring techniques for aircraft composite structures," *Progress in Aerospace Sciences*, vol. 46, no. 8, pp. 342-352, Nov. 2010.
- [3] J. W. Sheppard, M. A. Kaufman, and T. J. Wilmer, "IEEE Standards for Prognostics and Health Management," *Aerospace and Electronic Systems Magazine*, vol. 24, no. 9, p. 34-41, 2009.
- [4] J. Chen and R. J. Patton, "Review of parity space approaches to fault diagnosis for aerospace systems," *Journal of Guidance, Control, and Dynamics*, vol. 17, no. 2, 2012.
- [5] J. R. Massé, B. Lamoureux, and X. Boulet, "Prognosis and Health Management in system design," in *IEEE International Conference on Prognostics and Health Management*, Denver, 2011.
- [6] T. D. Wickens, *Elementary Signal Detection Theory*, N. Y. O. U. Press, Ed. 2002. (ISBN 0-19-509250-3).
- [7] T. Fawcett, *An introduction to ROC analysis*. 2164 Staunton Court, Palo Alto, USA: Institute for the Study of Learning and Expertise, 2005.
- [8] C. Gini, "Concentration and dependency ratios," *Rivista di Politica Economica*, no. 87, pp. 769-792, 1997.
- [9] A. I. J. Forrester and A. J. Keane, "Recent advances in surrogate-based optimization," *Progress in Aerospace Sciences*, vol. 45, no. 1-3, pp. 50-79, 2009.
- [10] J. P. C. Kleijnen, "Kriging metamodeling in simulation: a review," *European Journal of Operational Research*, vol. 192, no. 3, pp. 707-716, 2009.
- [11] S. N. Lophaven, H. B. Nielsen, and J. Søndergaard, DACE-A Matlab Kriging toolbox, version 2.0., 2002.
- [12] P. Casoli, V. Andrea, and G. Franzoni, "A Numerical Model for the Simulation of External Gear Pumps," in *Proceedings of the 6th JFPS International Symposium on Fluid Power*, Tsukuba, 2005.