



### Science Arts & Métiers (SAM)

is an open access repository that collects the work of Arts et Métiers Institute of Technology researchers and makes it freely available over the web where possible.

This is an author-deposited version published in: <https://sam.ensam.eu>  
Handle ID: <http://hdl.handle.net/10985/17847>

#### To cite this version :

Mohanad ALDHAIHAWI, Radu CHIRIAC, Viorel BDESCU, Georges DESCOMBES, Pierre PODEVIN - Investigation on the mixture formation, combustion characteristics and performance of a Diesel engine fueled with Diesel, Biodiesel B20 and hydrogen addition - International Journal of Hydrogen Energy - Vol. 42, n°26, p.16793-16807 - 2017

Any correspondence concerning this service should be sent to the repository

Administrator : [scienceouverte@ensam.eu](mailto:scienceouverte@ensam.eu)



# Investigation on the mixture formation, combustion characteristics and performance of a Diesel engine fueled with Diesel, Biodiesel B20 and hydrogen addition

Mohanad Aldhaidhawi <sup>a,b</sup>, Radu Chiriac <sup>a,d,\*</sup>, Viorel Bădescu <sup>a,e</sup>,  
Georges Descombes <sup>c</sup>, Pierre Podevin <sup>c</sup>

<sup>a</sup> University Politehnica of Bucharest, Faculty of Mechanical Engineering, Spl. Independentei 313, Sector 6, 060042, Bucharest, Romania

<sup>b</sup> Al-Furat Al-Awsat Technical University, Technical Institute of Kufa, Iraq

<sup>c</sup> CNAM – Laboratoire Chimie Moléculaire Génie des Procédés Chimiques et Energétiques, (CMGPCE-EA7341), 292 rue St-Martin, 75003, Paris, France

<sup>d</sup> Associated Member of CMGPCE-EA7341, CNAM, 292 rue St-Martin, 75003, Paris, France

<sup>e</sup> Romanian Academy, Calea Victoriei 125, Bucharest, Romania

---

## A B S T R A C T

An experimental and numerical study was performed to investigate the impact of Biodiesel B20 (blends 20% Rapeseed methyl ester with 80 % Diesel volumetric fraction) and different energetic fractions of hydrogen content (between 0 and 5%) on the mixture formation, combustion characteristics, engine performance and pollutant emissions formation. Experiments were carried out on a tractor Diesel engine, four-cylinders, four-stroke, 50 kW/2400 rpm, and direct injection. Simulations were conducted using the AVL codes (HYDSIM and BOOST 2013). Simulation results were validated against experimental data, by comparing the inline pressure, needle lift, in-cylinder pressure curves for Biodiesel B20 and pure Diesel fuels at 1400 rpm and 2400 rpm, respectively, under full load operating conditions. Good agreement with a maximum of 2.5% relative deviation on the peak results revealed that overall operation conditions Biodiesel B20 provides lower engine performance, efficiency, and emissions except the NO<sub>x</sub> which are slightly increased. The Biodiesel B20 has shorter ignition delay. By hydrogen addition to B20 with aspiration of the intake air flow the CO emissions, smoke, and total unburned hydrocarbon emissions THC decreased, while the NO<sub>x</sub> kept the same increasing trend for 1400 rpm and has not quite apparent trend for 2400 rpm. The enrichment by hydrogen of Diesel and B20 fuels has not a significant effect on ignition delay.

---

\* Corresponding author. University Politehnica of Bucharest, Faculty of Mechanical Engineering, Spl. Independentei 313, Sector 6, 060042, Bucharest, Romania. Fax: +40 21 318 1019.

E-mail addresses: [raduchiriac2001@yahoo.com](mailto:raduchiriac2001@yahoo.com), [radu.chiriac@upb.ro](mailto:radu.chiriac@upb.ro) (R. Chiriac).

---

## Introduction

Presently, increasing attention is being directed towards Biodiesel as an alternative fuel used either pure or in blends in compression ignition engines, due to the fact that Biodiesel is an oxygenated and renewable fuel, sulfur-free, contains no aromatics, is non-toxic and biodegradable. Biodiesel consists of fatty acid methyl or ethyl ester-based fuels that are produced from animal fats or vegetable oils via a chemical process called transesterification. Many researchers have argued the advance in start of fuel injection, shorter ignition delay and an advance in the combustion phase when using Biodiesel and its blends [1–7]. They reported as the main reason of these effects Biodiesel physical and chemical properties such as higher surface tension, higher cetane number (46.6–62 for Biodiesel vs. 44–46 for petroleum Diesel), 10–12% higher oxygen content, higher viscosity and lower volatility.

Previous studies [8–10] have focused primarily on the effect of Biodiesel on engine performance. The majority of these studies informed drops in effective power, effective torque, while brake specific fuel consumption increases, when the Biodiesel fraction in blend increases. The explanation of these behaviors may be due to the fact that Biodiesel has a lower heating value and higher density than pure Diesel fuel [11,12].

Several studies in the literature concluded that the carbon monoxide, smoke and particulate matter size were decreased when using Biodiesel and its blends in respect to Diesel fuel [13,14]. The 10–12% oxygen content of Biodiesel, present during the combustion process, and the higher cetane number of Biodiesel and its blends improved the combustion and resulting on the exhaust gas emissions. How et al. [15] investigated the effect of Biodiesel obtained from coconut as blends (B10, B20, B30 and B50) in a Diesel engine with five different load operating conditions (0.17, 0.34, 0.52, 0.69 and 0.86 MPa as brake mean effective pressure BMEP) on the emissions, performance and combustion characteristics. The results showed that Biodiesel blends fuels have significant influences on the brake specific fuel consumption (BSFC), a slightly shorter ignition delay and longer combustion duration, a large reduction up to 52.4% in smoke opacity compared to Diesel fuel.

Can [16] experimentally investigated the effect of using Biodiesel obtained from waste cooking oil and its blends (B5 and B10) as fuels in a single cylinder, naturally aspirated direct injection Diesel engine under four different engine loads (BMEP 0.4, 0.36, 0.24, 0.12 MPa) at constant engine speed 2200 rpm. The results showed a slight decreased in break thermal efficiency (BTE) up to 2.8%, the maximum heat release rate and the in-cylinder pressure rise rate which were slightly decreased, the brake specific fuel consumption increased up to 4%, the smoke and total hydrocarbon emissions were decreased, whereas, the NO<sub>x</sub> emissions were increased up to 8.7% for all engine loads. Sanli et al. [17] investigated a 136 kW rated power direct injection CI engine fueled with waste frying oil-based methyl and ethyl ester (pure Biodiesel and B20) running at 600 Nm and different engine speeds (1100, 1400 and 1700 rpm). The results showed that the brake specific fuel consumptions (BSFC) and the thermal efficiency were higher of Biodiesel base ester fuels than those of Diesel fuel. In general, they concluded that the ethyl ester Biodiesel released

relatively fewer emissions than methyl ester Biodiesel and Diesel fuels.

Harch et al. [18] developed an engine combustion model using the CFD software, AVL fire that can predict the performance, emissions and component wear of the CI engine fueled with second generation Biodiesel and its blends. The effect of the Biodiesel blends (B5 and B10) on the fuel atomization, burning velocity, combustion duration, cylinder temperature and pressure development in the combustion chamber have been analyzed. The simulation results revealed that, B10 Biodiesel provides better performance and efficiency, and significantly reduction in engine emissions than Diesel fuel. The effect of Rapeseed oil and its blends (B25, B50, and B75) on Diesel engine performance was experimentally and numerically investigated using AVL BOOST by Ref. [19]. The study results showed that the advance in start of fuel injection and start of combustion was apparent when used Biodiesel and its blends.

Today, there are few studies investigating the association of Biodiesel with hydrogen as a complementary fuel. Chiriac and Apostolescu [20] studied the effects of hydrogen addition to 20% of Biodiesel on emissions of a tractor Diesel engine four-cylinders, four-stroke, direct injection system, of 50 kW at 2400 rpm which was fueled with Biodiesel Rapeseed methyl ester. The investigation was carried out at 1400 rpm and 2400 rpm at 60% load. A supplement of hydrogen to B20 by aspiration in the intake air flow at 60% load lead to an increase of NO<sub>x</sub> emissions up to 7% at high speed; a similar effect had on petroleum Diesel fuel the enrichment with hydrogen. Smoke and CO emissions were lowered by hydrogen addition to B20. With the same objective, a numerical study was conducted on a Diesel engine fueled Biodiesel with supplementary hydrogen (0.5, 1, 2 and 3% by volume) in the air intake manifold at different engine speeds and loads [21]. The simulation results showed that in terms of combustion, a general increase was observed for the peak cylinder pressure and for the heat release rate, while there was no significant effect on ignition delay. In terms of emissions, the hydrogen presence determined CO and soot emissions decreasing up to 23.5% overall tested operating conditions.

Uludamar et al. [22] set up a series of virtual experiments using different types of biodiesel at blends with 20% and 40% volume ratio, enriched with hydrogen by injection into the inlet manifold with 3 L/min and 6 L/min flow rates. The results were obtained on an unmodified four stroke four-cylinder Diesel engine at various engine speeds under no load condition. Their data showed a reduction in CO, HC and NO<sub>x</sub> emissions compared to biodiesel without hydrogen addition.

In another study were investigated the engine performance and exhaust gas emissions of Diesel engine fueled with Diesel and biodiesel enriched by hydrogen. This study was carried out by Karagoz et al. [23]. The results obtained at constant engine speed 1100 rpm and engine load (40%, 60%, 75% and 100%) shown that engine load affects NO<sub>x</sub> emissions significantly, with some increasing in THC emissions, while the CO<sub>2</sub> and CO emissions were decreased. In terms of efficiency, the brake thermal efficiency decreased, whereas, peak in-cylinder pressure values and peak heat release rate values were increased at all engine loads with hydrogen addition compared with neat Diesel and biodiesel fuel.

Baltacioglu et al. [24] reported that effective torque, effective power slightly increased, while brake specific fuel consumption was decreased. Concerning emissions CO and CO<sub>2</sub> decreased, but the NO<sub>x</sub> emissions were increased with biodiesel and biodiesel enriched hydrogen compared to pure Diesel.

As shown in the above literature, a lot of efforts are being made to use Biodiesel and its blends as fuel in compression ignition engines to experimentally and theoretically address issues related to performance, combustion and emission characteristics. However, the experimental analysis requires costly logistic support, while a simulation model can be developed to predict engine performance, combustion and emissions characteristics using Biodiesel and its blends fuels with lower costs and time. Actually, the most common Biodiesel blends presently used on the market is B5 (5 percent Biodiesel mix with Diesel fuel). It can be used in unmodified Diesel engines and is marketed as regular Diesel in most countries, but this blend does not affect the final fuel price. The United States and the European Union are planning to use B20 in the near future. Biodiesel B20 (20 percent by volume Biodiesel in Diesel fuel) offers a good compromise between features as cost, cold-weather start-up, environmental benefits, material compatibility, and temperature stability [25].

The present work is an extension of the work reported earlier by Chiriac and Apostolescu [20] with emphases on the effect of Biodiesel B20 at full load and different engine speeds on mixture formation, combustion and engine performance. A simulation model is proposed by using AVL codes (HYSIM and BOOST 2013) to predict the mixture formation, engine performance, combustion characteristics and emissions. The model was validated against experimental data. The effect of enriched Diesel and B20 with different energetic fractions of hydrogen content between (0–5%) on engine emissions and combustion was also experimentally addressed. The structure of paper consists in five parts, starting with the introduction,

followed by the experimental setup, simulation procedure and modeling, results and discussions and ending by the conclusions.

## Experimental infrastructure

A four-cylinder, four-stroke, naturally-aspirated, water-cooled, direct injection tractor Diesel engine coupled with devices for measuring equipment's in order to determine the performance parameters, exhaust gas emissions and indicating parameters was used in this study as shown in Fig. 1. The experimental setup is extensively described in Ref. [20]. The basic engine specifications used in this study are: bore × stroke 102 × 115 mm, compression ratio 17.5:1, rated output 50 kW at 2400 rpm, and maximum torque of 228 Nm at 1400 rpm. An injection system Delphi comprising a DP210 rotary pump, pressure lines three Delphi fuel injectors having five holes of 0.24 mm diameter with an opening pressure of 330 bars and one Perkins-Lucas injector supplied by WOLFF Controls Corporation (WCC) comprising a Hall effect position sensor for the needle lift recording was fitted on the engine. Two AVL GM 12D pressure transducers with sensitivity 15.76 pC/bar were used to measure the in cylinder pressure, and one AVL QL21D pressure transducer with sensitivity 2.5 pC/bar and maximum measuring range of 3000 bar was used to measure high pressure line values.

The test bed adapted for multiple fuels operation has been modified for the purpose of the present work, allowing the engine to be alternatively fueled with the tested fuels, i.e. Diesel and Biodiesel B20 enriched with hydrogen. The hydrogen gas was stored in special bottles at high pressure and was introduced through a dedicated line at low pressure into the intake manifold together with the air flow. The special instrumentation such as: pressure regulators, thermocouples, pressure gauges, electronic precision gas flow meter type

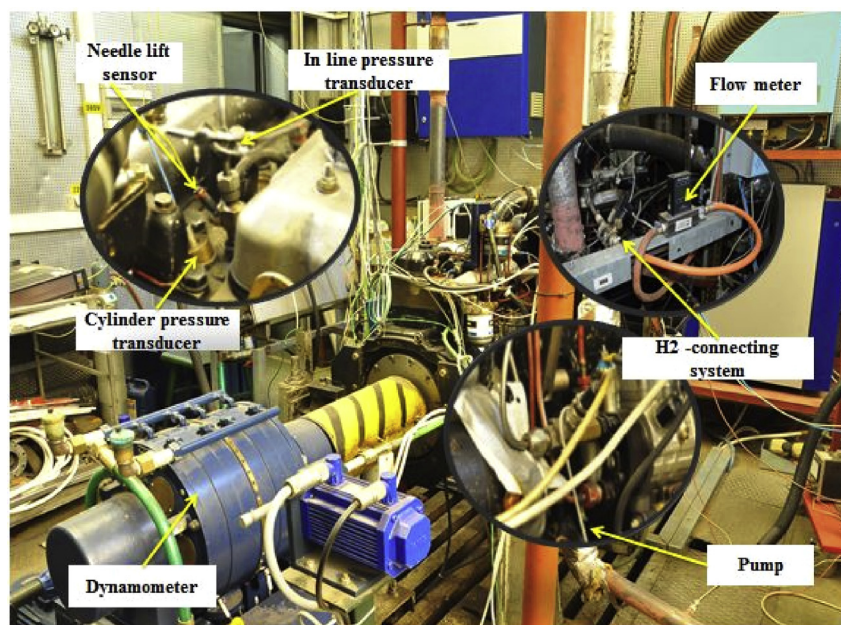

Fig. 1 – Schematic layout of the test bench.

ALICAT Scientific M series, and two flame arrestors equipped with one-way valve and an emergency rapid stop valve was properly selected to ensure safety operation and monitoring of the engine when it was partially fueled by the hydrogen gas. The performance and emissions of the engine were monitored and registered at two engine speeds 1400 rpm (speed for maximum brake torque) and 2400 rpm (speed for maximum brake power), full load.

## Simulation procedures

Due to advances in computational hardware, AVL Workspace has become an option to study the mixture formation, engine performance, and combustion characteristics and emissions generation in a wide variety of engines. Hence, two models were created to understand the mixture formation using AVL-HYDSIM, and AVL-BOOST was utilized to predict the engine performance, combustion and emissions characteristics.

### AVL-HYDSIM model

The numerical analysis of the injection characteristics is presented in this work. The simulation model was created by using the AVL-HYDSIM simulation program. The effect of

Diesel and Biodiesel B20 on the fuel mixture formation at engine speeds of 1400 rpm and 2400 rpm under full load operating conditions were investigated. Hence, the injection components, such as: pump geometry, injection pipe, injector geometry, nozzle bore, nozzle chamber, needle, nozzle orifice were implemented in the AVL-HYDSIM code interface based on the real values of the existing Delphi system. All the components are linked together by pipes as shown in Fig. 2.

There are several parameters which must be implemented for the program before starting the simulation. These parameters have been selected according to the fuel properties and the fuel injection system parts dimensions. The model considering the fuel injector with five 0.24 mm diameter holes with an opening pressure of 330 bars was selected in this study. The injection pipes on the test bench were measured and the correct dimensions were requested as input data for the AVL-HYDSIM model.

### AVL-BOOST simulation model

The numerical model was built using the AVL-BOOST 2013 simulation code to estimate the engine performance, efficiency, combustion characteristics and exhaust gas emissions. The engine calibration parameters of the cylinder processes simulation were selected by using the base documentation (AVL-

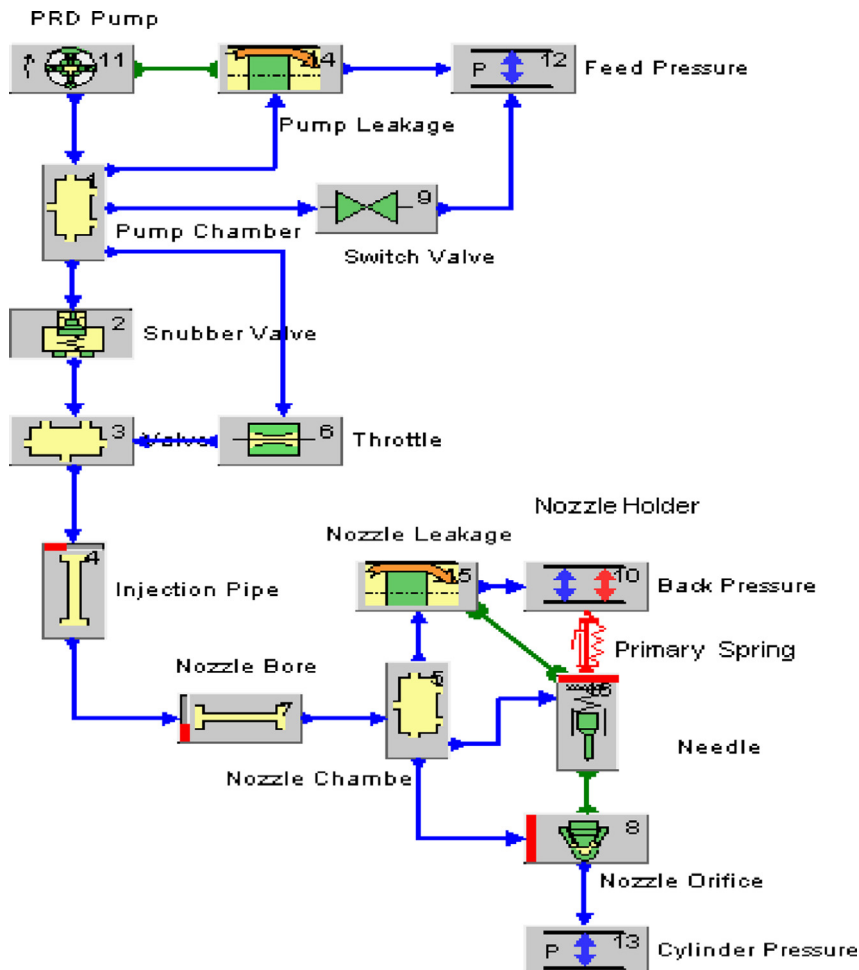

Fig. 2 – AVL-HYDSIM – simulation model.



BOOST Theory and AVL-BOOST Users Guide v2013) [26]. Hence, the engine components, such as: the intake and exhaust manifolds, cylinder geometry, air filter, hydrogen injector, system boundaries and plenums were implemented in the BOOST interface based on the real values which were taken from the engine geometry on the test bed used in this study. All the components are linked together by pipes as shown Fig. 3 [27].

The start and the rate of fuel injection, air and fuel mass flow rate were experimentally measured and implemented in the AVL-BOOST program for Diesel and B20 at engine speed 1400 rpm and 2400 rpm, full load. Many of the parameters were changed in this visual manner, together with their net effect on performance, combustion and emissions output in order to fit the simulation results to the experimental data. Usually a large number of simulation test runs are needed for an accurate determination of the combustion model's parameters. The values of the calibration parameters were chosen considering to the AVL-MCC combustion model and the Woschni 1990 heat transfer model.

## Results and discussions

In this part of the study, the results are collected under the operating conditions and divided into two groups: the first group of results is related to experimental and simulation on the mixture formation, performance and emissions for the two fuels tested, pure Diesel and Biodiesel B20 fuels. The second group of results is related to the experimental data on the pollutant emissions and combustion characteristics for both fuels enriched with hydrogen in small energetic fractions up to 5%.

### Results related to experimental and simulation on mixture formation and performance for pure Diesel and Biodiesel B20 fuels

#### Needle lift

The variations of needle lift versus the crankshaft angle position for Diesel and Biodiesel B20 experimental and numerical are presented in Figs. 4 and 5. It is clear from these pictures

that the needle lift of Biodiesel B20 fuel was slightly advanced and has higher peak value than Diesel fuel overall operating conditions. This may be due to the fact that Biodiesel has higher bulk modulus, higher density and higher viscosity resulting in increasing of the pressure in the injection pipe leading thus to faster needle lift jump. Good agreements with a maximum relative deviation of 3% on the peak needle lift are obtained when compare with experimental data.

#### Sauter mean diameter (SMD)

Sauter mean diameter (SMD) is the average diameter of the droplets that have the same volume to surface area ratio as that of the total spray. The variation of the SMD with respect to the crankshaft angle position at 2400 rpm and 1400 rpm and full load operating condition numerically obtained is shown in Fig. 6. As reveals this figure, the SMD of Biodiesel B20 is similar to Diesel fuel for both speeds excepting the last part of the injection process. Smaller values are registered for 2400 rpm in the central part of the process but the trend is comparable as for 1400 rpm, this being in accordance with higher in-line pressures registered for 2400 rpm. For the main part of injection, the SMD presents not significant differences between Diesel and B20 but at 1400 rpm in the end of injection, for B20 it becomes larger than of Diesel fuel, and this is probably due to the higher bulk modulus, density and viscosity of the Biodiesel. This finding is consistent with the results reported in the study [28] which used Biodiesel and its blends in similar Diesel engines.

#### In-line pressure

Figs. 7 and 8 show the variation of in-line pressure versus the crankshaft angle position for pure Diesel and B20 at the same operating conditions. It can be seen in these figures that the in-line pressure is advanced and increased with higher maximum values for B20 compared to the Diesel fuel. The advance of the start of increase in the line pressure can be explained due to the fact that Biodiesel has higher viscosity relative to Diesel fuel. Overall operating conditions, the simulation results related to in-line pressures for both engine speeds and tested fuels are in an agreement with the experimental data.

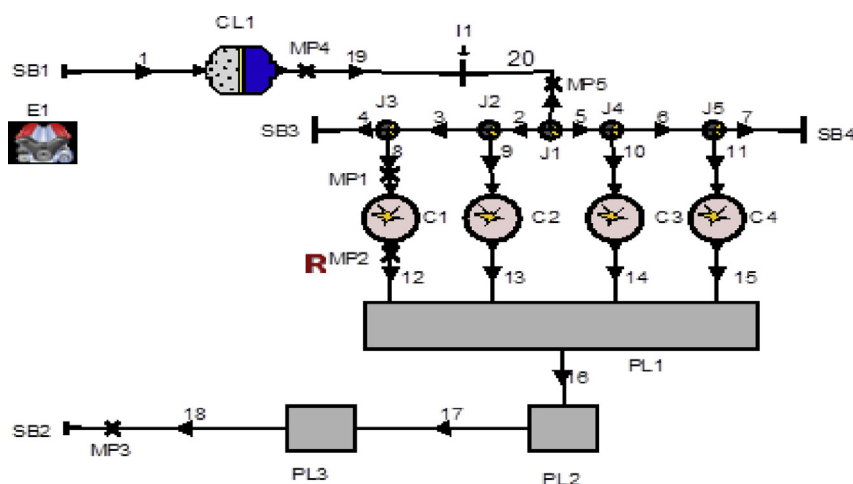

Fig. 3 – AVL-BOOST – simulation model.

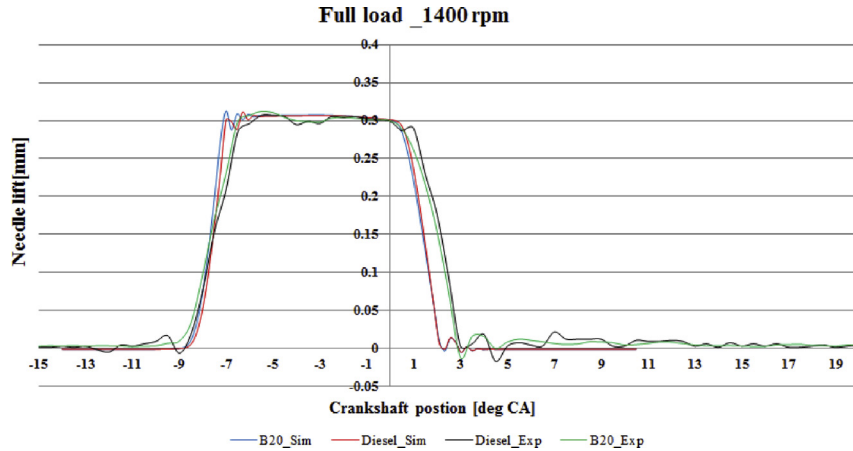

Fig. 4 – Variation of needle lift for Diesel and B20-INDICOM experimental vs. HYDSIM simulation at 1400 rpm.

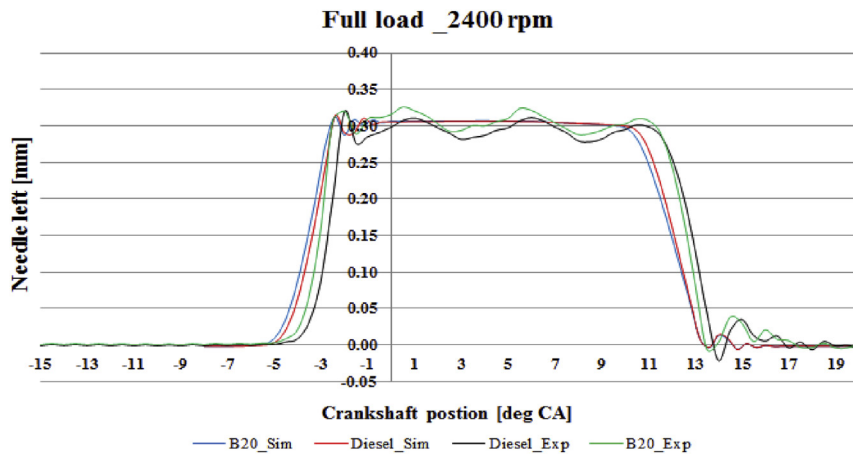

Fig. 5 – Variation of needle lift for Diesel and B20-INDICOM experimental vs. HYDSIM simulation at 2400 rpm.

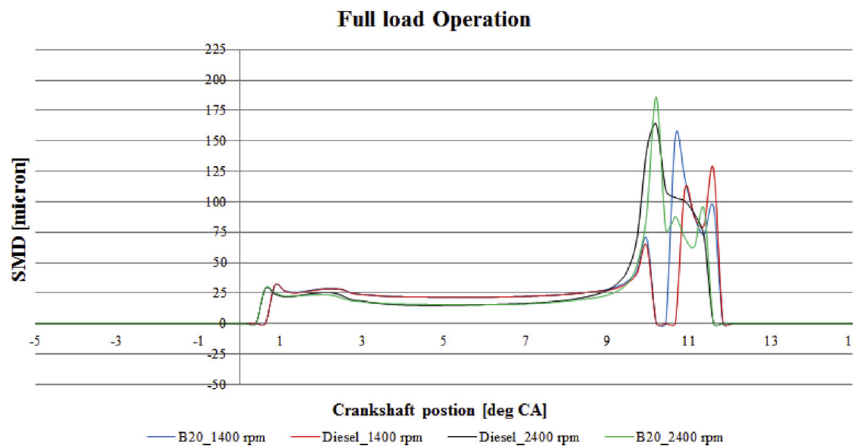

Fig. 6 – Variation of SMD for Diesel and B20-HYDSIM simulation at 1400 rpm and 2400 rpm.

### Spray penetration

The spray penetration can be defined as the distance covered by the spray tip through the combustion chamber as function of time. The penetration distance in the combustion chamber in the Diesel engines has crucial influence on air use and fuel-air mixing rates. Variation of the penetration distance versus

the crankshaft angle position for Diesel and Biodiesel B20 at the same testing conditions is shown in Fig. 9. Thus, the penetration distance increases faster for Biodiesel B20 in comparison with that of Diesel fuel. This increasing in the penetration is probably due to the higher density and viscosity of B20. The penetration distance of the tested fuels increased

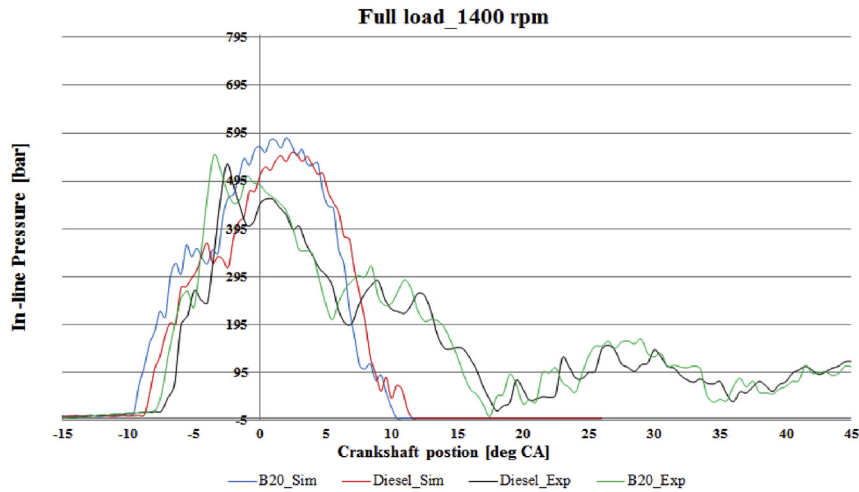

Fig. 7 – Variation of in-line pressure for Diesel and B20-INDICOM experimental vs. HYDSIM simulation at 1400 rpm.

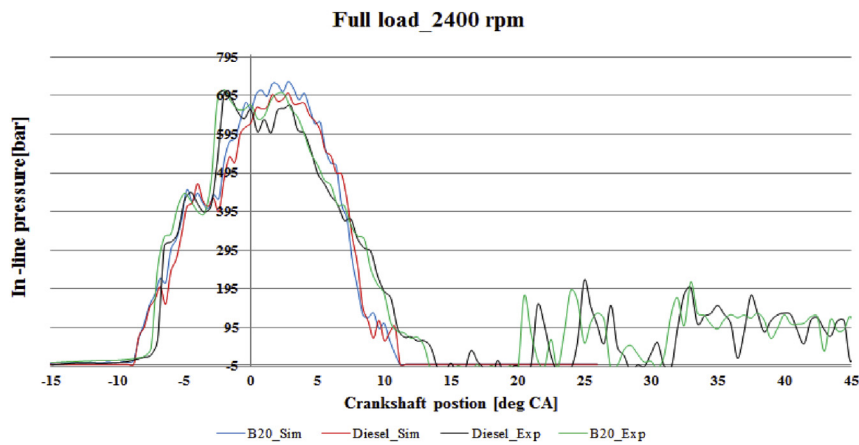

Fig. 8 – Variation of in-line pressure for Diesel and B20-INDICOM experimental vs. HYDSIM simulation at 2400 rpm.

significantly for the rated power speed of the engine. Hence, the peak penetration distance increased from 26.9 mm with base Diesel to 27.1 mm for B20 at 2400 rpm and from 15.2 mm for Diesel to 15.6 mm for B20 at 1400 rpm.

*Spray cone angle*

The spray cone angle is defined as the angle of the cone formed by the tangents to the spray envelope crossing through the nozzle orifice. Fig. 10 shows the spray cone angle produced by

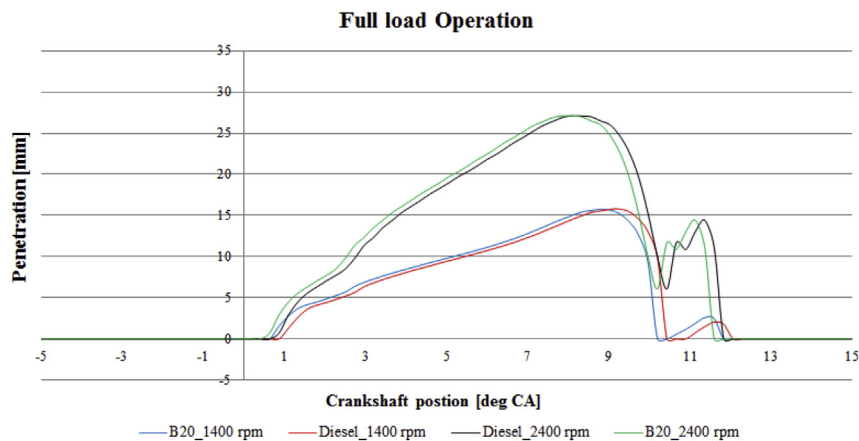

Fig. 9 – Variation of spray penetration for Diesel and B20-HYDSIM simulation at 1400 rpm and 2400 rpm.



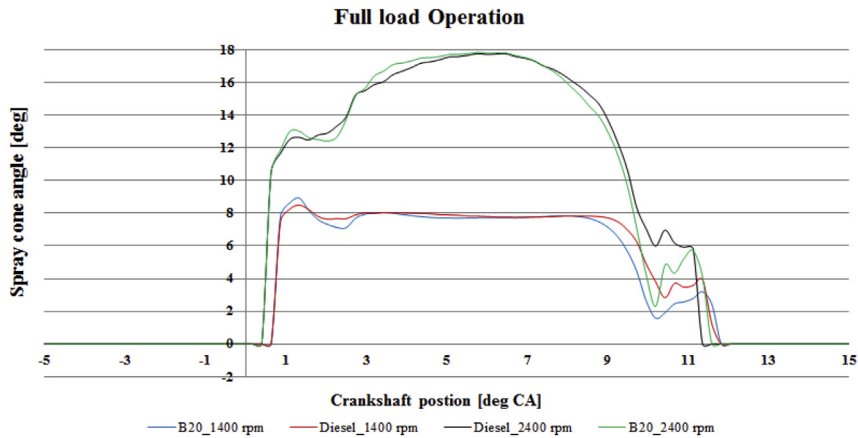

Fig. 10 – Variation of spray cone angle for Diesel and B20-HYDSIM simulation at 1400 rpm and 2400 rpm.

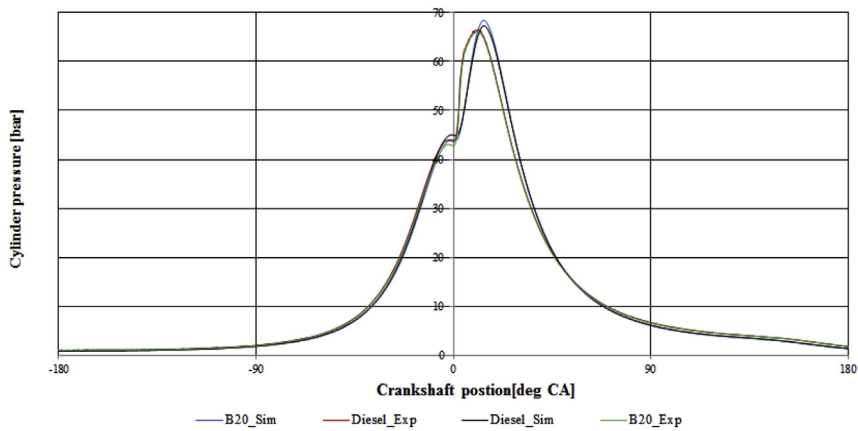

Fig. 11 – Comparison between experimental and simulation pressure traces for full load, 1400 rpm speed.

Diesel and Biodiesel B20 as a function of engine operating conditions to the crankshaft angle position. The curves show that there is a similar trend for spray cone angle variations for the both tested fuels. The spray cone angle for Biodiesel B20 at 2400 rpm and 1400 rpm is lower than for Diesel fuel due to the fact that Biodiesel B20 has a higher viscosity than pure Diesel. More recent studies have confirmed this finding and they

concluded that the spray cone angle decreases when Biodiesel fractions are increased in blends [1,29,30].

#### Cylinder pressure

The variations of cylinder pressure with respect to the crank angle, experimental and simulation for the Diesel and Biodiesel B20 at full load and engine speed 1400 rpm and

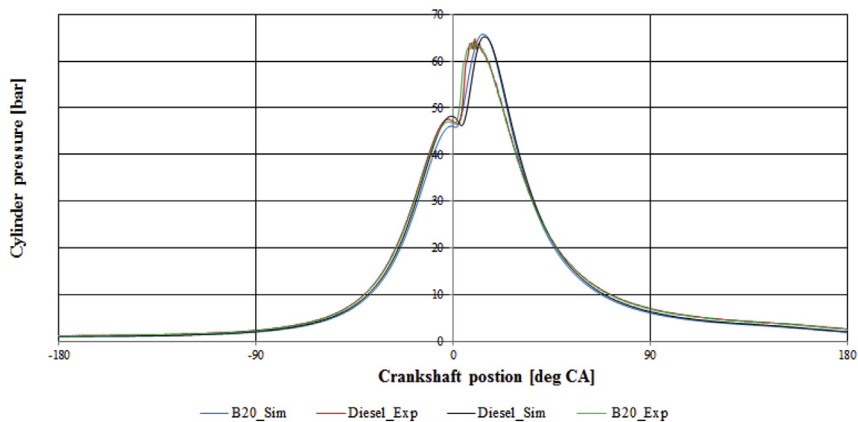

Fig. 12 – Comparison between experimental and simulation pressure traces for full load, 2400 rpm speed.

**Table 1 – Comparison between simulation and experimental results at engine speed (1400 and 2400 rpm) and full load for Diesel and Biodiesel B20.**

Fuel	$T_e$ [N m]		$P_e$ [kW]		BSFC [g/kWh]		BTE [%]		NOx [ppm]		CO [ppm]	
1400 rpm												
	Sim	Exp	Sim	Exp	Sim	Exp	Sim	Exp	Sim	Exp	Sim	Exp
Diesel	221.5	224.21	32.6	32.86	239.3	236.39	35.1	36.4	1048.5	1045	839.5	864
St. dev	1.208%		0.79%		-1.23%		3.57%		-0.33%		2.83%	
B20	218.12	216.2	32.19	31.71	250.95	254.97	33.8	33.3	1050	1027	640	637
St. dev	-0.88%		-1.51%		1.57%		-1.5%		-2.23%		-0.47%	
2400 rpm												
	Sim	Exp	Sim	Exp	Sim	Exp	Sim	Exp	Sim	Exp	Sim	Exp
Diesel	190.4	188.4	47.8	47.4	252.5	255	34.1	33.7	625	640	590	612
St. dev	-1.06%		-0.84%		0.98%		-1.18%		2.34%		-3.59%	
B20	188.7	186.5	47.5	46.80	257.9	261.8	34.6	34.2	714	726	551	538
St. dev	-1.179%		-1.49%		1.51%		-1.169%		1.65%		-2.41%	

2400 rpm are presented in Figs. 11 and 12. It is clear from these figures, that good fitting between the two pressure traces, experimental and simulation overall operation conditions has been acquired. The maximum relative deviation of 2.51% on the peak fire pressure was registered when compared with experimental data for Diesel fuel at 1400 rpm.

#### Engine performance

The engine performance, efficiency indicators and exhaust gas emissions at the mentioned operation conditions, as simulation results with relative deviations in comparison with the experimental data are summarized in Table 1. The oxygen content 10–12% wt/wt and higher cetane number of Biodiesel

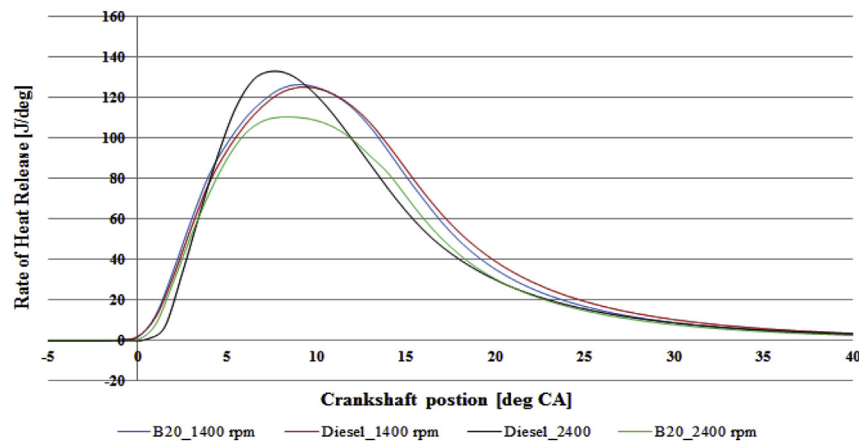

**Fig. 13 – Rate heat release as a function of crankshaft position, at full load for Diesel and B20 at 1400 rpm and 2400 rpm.**

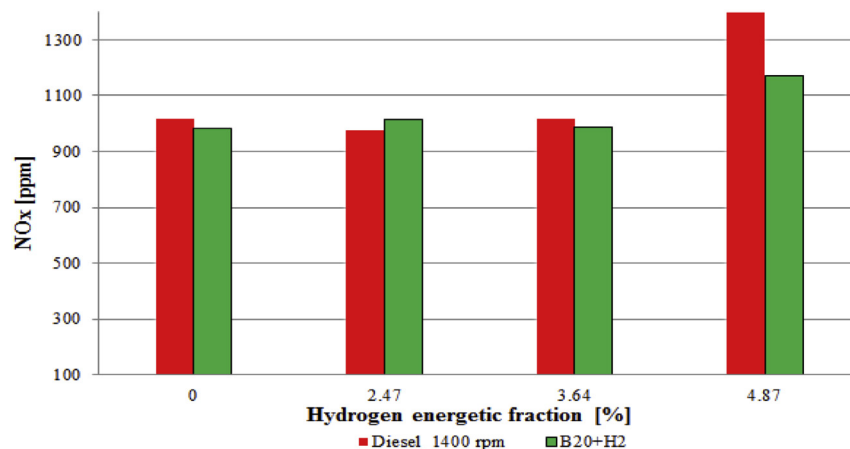

**Fig. 14 – Variation of NOx with hydrogen percentage at full load, 1400 rpm.**

B20 improves combustion resulting in CO reduction but slight increase of NOx emissions. Moreover, Biodiesel B20 having higher density and lower heating value than Diesel fuel leads to the increasing of BSFC with 7.6% coupled with a reduction by 3.5% of the engine output at 1400 rpm.

*Rate of heat release*

The rate of heat release for Diesel and Biodiesel B20 as a function of crankshaft angle position overall operation conditions predicted by the simulation model are shown in Fig. 13. The Biodiesel B20 registers an advance in the apparent rate of heat release; the explanation for this behavior could be the fact that Biodiesel B20 having higher bulk modulus and viscosity leads to the slight advance in the start of injection with the small modification of the premixed stage of combustion process. Moreover, the rate of heat release for Biodiesel B20 is lower during mixing controlled combustion stage. The lower heating value, lower volatility and higher viscosity for Biodiesel fuel compared to the Diesel fuel are the main reasons for altering the combustion characteristics.

*Results related to emissions of Diesel and Biodiesel B20 with hydrogen enrichment*

After experimental tests and simulation results obtained on pure Diesel fuel and Biodiesel B20 another set of tests has been carried out at the same operating conditions for both fuels enriched with different small fractions of hydrogen (0–5% energetic fractions). The analysis of engine operation at full load revealed no major changes in engine performance parameters but important variations on measured emissions.

*Nitrogen oxides*

The variation of nitrogen oxides NOx emissions in respect to the energetic fraction of hydrogen enriched Diesel and Biodiesel at full load and different engine speeds are shown in Figs. 14 and 15. At engine speed 1400 rpm, the NOx emissions decreased up to 17.4% for Biodiesel B20 when enriched by 4.7% hydrogen compared to Diesel fuel. At engine speed 2400 rpm, the NOx emissions were decreased for both fuels compared with the low engine speed. Moreover, it can be observed that

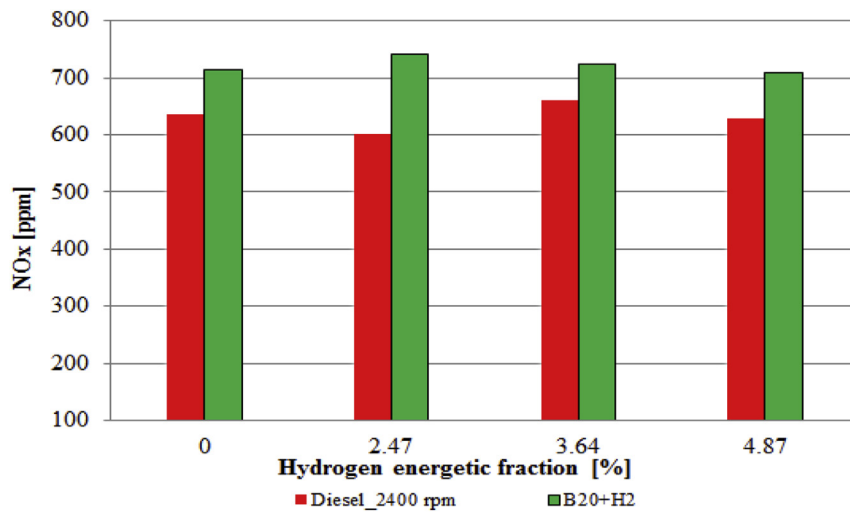

Fig. 15 – Variation of NOx with hydrogen percentage at full load, 2400 rpm.

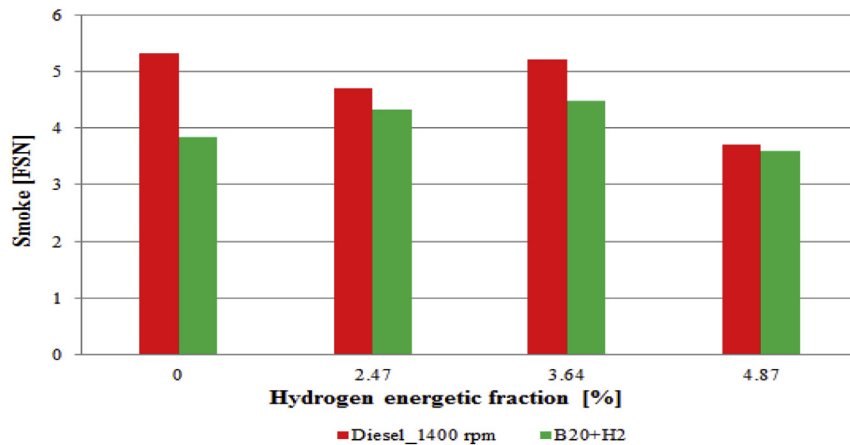

Fig. 16 – Variation of Smoke emission with hydrogen percentage at full load, 1400 rpm.

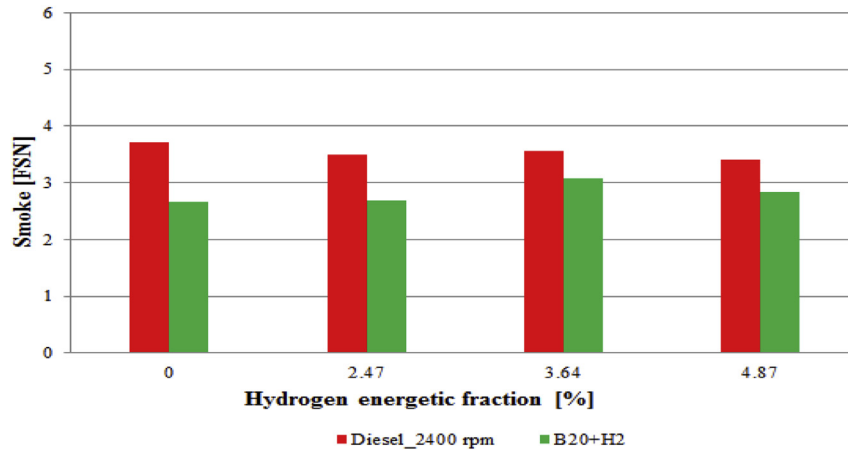

Fig. 17 – Variation of Smoke emission with hydrogen percentage at full load, 2400 rpm.

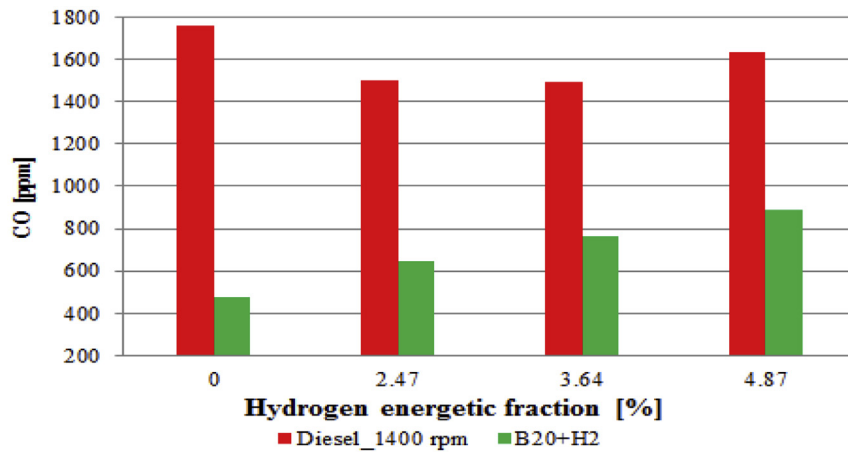

Fig. 18 – Variation of CO with hydrogen percentage at full load, 1400 rpm.

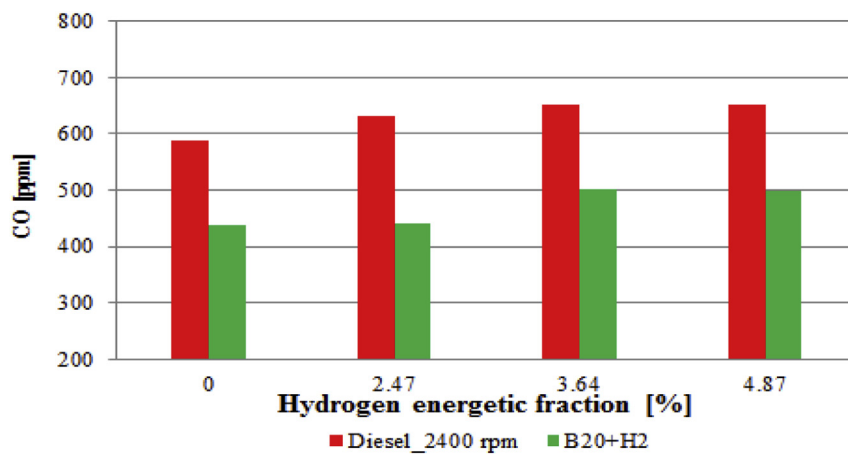

Fig. 19 – Variation of CO with hydrogen percentage at full load, 2400 rpm.

the NO<sub>x</sub> emissions were decreased up to 9.36% for Diesel fuel compare to Biodiesel B20 fuel at high speed. This may be due to decreased radiation heat transfer due to lower soot concentration and to the present higher oxygen content of Biodiesel which can be associated with a higher post flame temperature.

#### Smoke

Smoke emission measured in Filter Smoke Number (FSN) decreased for Biodiesel B20 as compared to base Diesel at 1400 rpm and 2400 rpm as shown in Figs. 16 and 17. For engine speed 1400 rpm, FSN decreased by 29%, when pure Diesel fuel

is substituted by Biodiesel B20. A similar effect is registered for 2400 rpm where the decrease is 27%. This may be due to oxygen content of the Biodiesel molecule, which can be associated with a higher post flame temperature enabling complete combustion. Hydrogen enrichments lead to decrease of smoke with 7.87%, 13.6% and 2.7% by hydrogen fractions of 2.47%, 3.64% and 4.87% at 1400 rpm for Diesel fuel, whereas with B20 this trend is not so clear. A slight reduction by 5% is registered only with 4.87% hydrogen enrichment. At engine speed 2400 rpm the presence of hydrogen in fractions of 2.47%, 3.64% and 4.87% decreases smoke by 5%, 4.8% and 10.5% for pure Diesel fuel, but the influence is not similar for B20. In the case of pure Diesel fuel, the smoke level is generally higher than B20 and the influence of hydrogen addition is not similarly coherent. While for pure Diesel fuel the hydrogen presence at low speed has an important effect for high speed this effect is not notable. For both engine speeds FSN seems to be almost insensitive to hydrogen addition. In this sense, it appears that the active role of hydrogen atoms in soot formation by propagating the aromatic ring formation is in competition with OH radicals formation, acting as soot formation suppressors. The effect of fuel enrichment with hydrogen on the balance between the rate of formation and the rate of oxidation on the filter smoke number is not so apparent.

#### Carbon monoxide emission

The variation of carbon monoxide to the hydrogen enrichment at same operation conditions is presented in Figs. 18 and 19. The CO emission was lowered with B20 compared to pure Diesel, due to the fact that Biodiesel is an oxygenated fuel. When enriched Diesel fuel and B20 with hydrogen, the CO emission was decreased. This decreasing was up to 63.14% by enrichment of B20 with 2.47% hydrogen compared to Diesel fuel. The reduction of the CO emission may be attributed to the oxygen content of Biodiesel, which can be associated with a higher post flame temperature that enables complete combustion. A slight trend of increasing the CO emission by hydrogen enrichment is noticeable for Biodiesel B20 and this behavior can not be explained by simply substitution in fuel oxidation of carbon with hydrogen. It is possible that hydrogen in certain conditions to suppress the kinetics of CO–O<sub>2</sub> reaction in the so-called “wet mechanism” of CO oxidation.

#### Total unburned hydrocarbons

The total unburned hydrocarbons (THC) emissions decrease for Biodiesel B20 as compared to base Diesel fuel as shown in Figs. 20 and 21. The enrichment of Diesel and B20 with hydrogen led to more reduction in THC. The THC emissions decreased up to 25% with B20, due to the active oxidation

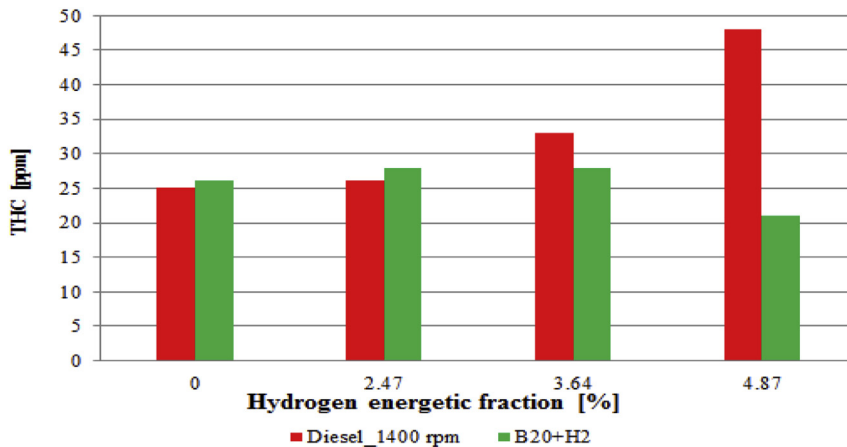

Fig. 20 – Variation of THC with hydrogen percentage at full load, 1400 rpm.

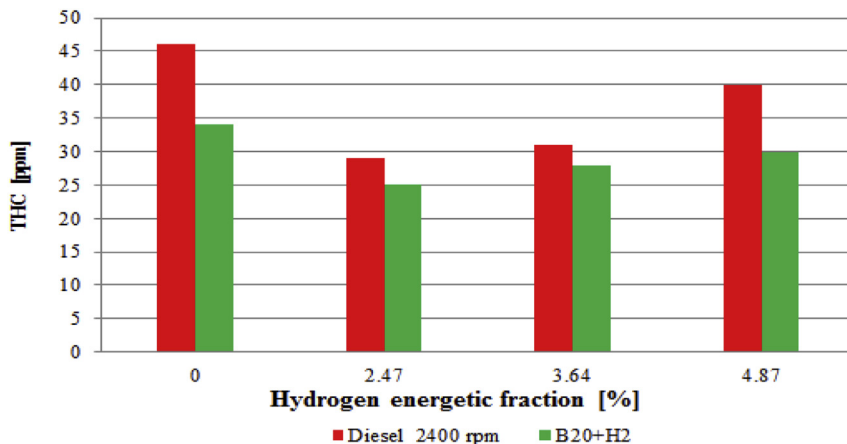

Fig. 21 – Variation of THC with hydrogen percentage at full load, 2400 rpm.



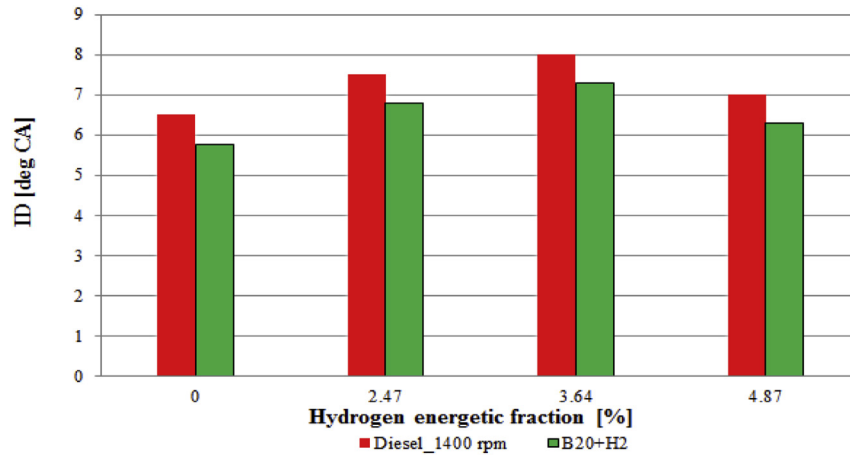

Fig. 22 – Variation of ID with hydrogen percentage at full load, 1400 rpm.

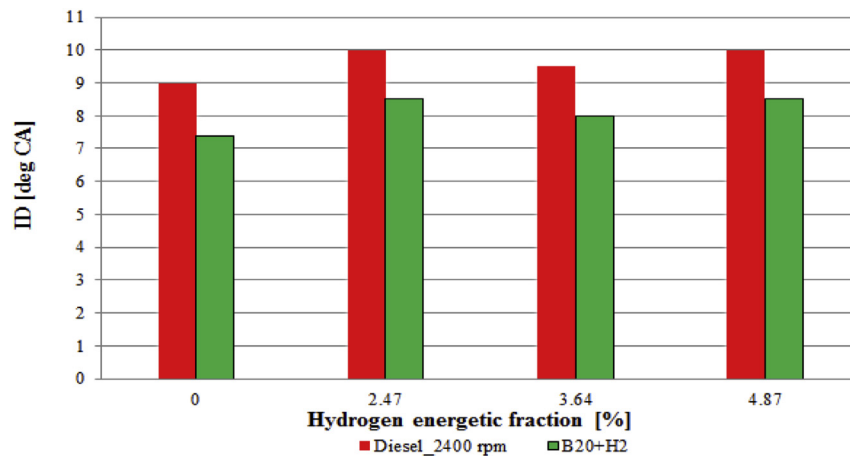

Fig. 23 – Variation of ID with hydrogen percentage at full load, 2400 rpm.

process which is developed in quite similar environmental conditions which enables complete combustion.

#### Ignition delay (ID)

Ignition delay (ID) in a compression ignition engine is defined as the period between the start of fuel injection and the start of combustion. Start of fuel injection is usually taken as the time when the injector needle lifts off its seat. In this study, the start of combustion was predicted from the change in slope of the heat release rate. The variation of ignition delay with respect to the hydrogen fraction at full load for pure Diesel and Biodiesel B20 is shown in Figs. 22 and 23. From these figures it expresses that Biodiesel B20 has shorter ignition delay than Diesel fuel. The reduced values of ignition delay for B20 in respect to Diesel fuel is caused probably by higher cetane number of B20. The Biodiesel has higher cetane number (46.6–62) [1,3,4]. The hydrogen addition seems that does not affect mixture formation either for Diesel and for B20 before the combustion starts and this is due to the fact that hydrogen content is in small fractions and hydrogen has higher autoignition temperature 858 K [31], whereas the

autoignition temperatures of Diesel and B20 are 783.1 K and 799.8 K respectively [32].

#### Conclusions

An experimental and numerical study was performed for analyzing the effect of Biodiesel B20 on engine performance, combustion and emissions characteristics of a tractor Diesel engine operating at full load and different speeds (1400 rpm, the maximum torque speed and 2400 rpm the maximum power speed). The numerical study was developed using the AVL-HYDSIM and AVL-BOOST 2013 codes for predicting mixture formation, combustion characteristics and emissions. Moreover, it was experimentally studied the effects of hydrogen enrichment in different energetic fractions (from 0 to 5%) for Diesel and B20 fuels on engine emissions and combustion. The main conclusions are listed in the following:

- Higher penetration distance was predicted for Biodiesel B20, resulting in an increase in the chances of wall impingement and consequently in increased the NO<sub>x</sub> formation.

- Higher bulk modulus, density and viscosity for Biodiesel B20, resulted in the increase of the SMD and in-line pressure, whereas the spray cone angle was decreased compare to Diesel fuel.
- The higher oxygen content of 10–12% for Biodiesel B20 enhanced the combustion process resulting the reduction in CO, THC and smoke emissions.
- BSFC was higher with Biodiesel B20 overall operation conditions due to the reduced value of the lower heating value for B20 than for Diesel fuel.
- The effective power and effective torque were lower with B20 compared to Diesel fuel.
- The Biodiesel B20 has shorter ignition delay overall operating conditions than Diesel fuel; these reduced values are caused by higher cetane number of B20.
- The simulation results for the two engine speeds and test fuels, compared with experimental data, are in accordance and hence the simulation models developed by using advanced tools have been proven to be reliable and adequate for the proposed objectives.
- Overall operation conditions, the hydrogen added to pure diesel and B20 enhances the combustion resulting in a reduction of THC and smoke emissions.
- Concerning the NOx emissions these were increased at 1400 rpm, whereas, the hydrogen presence had no an apparent effect for engine speed 2400 rpm.
- Hydrogen addition in small amounts changes the engine emissions probably due to the subtle interactions occurring in combustion development after the unchanged auto-ignition of the base fuels (Diesel or Biodiesel B20). The start of combustion event remained the same for Diesel respectively for B20 without significant effect of hydrogen addition.

---

## Acknowledgements

The authors acknowledge the AVL Advanced Simulation Technologies team for the significant support they have offered in performing the simulations.

The authors acknowledge financial support through the research grant code PN-II-PT-PCCA-2011-3.2-0059, Grant no. 75/2012.

Mr. Mohanad Aldhaidhawi thanks the Iraqi government for the financial support.

## REFERENCES

---

- [1] Subhash L, Subramanian K. Effect of different percentages of biodiesel-diesel blends on injection, spray, combustion, performance, and emission characteristics of a diesel engine. *Fuel* 2015;139:537–45.
- [2] Zhang J, Jing W, Roberts W, Fang T. Effects of ambient oxygen concentration on biodiesel and diesel spray combustion under simulated engine conditions. *Energy* 2013;57:722–32.
- [3] Qi D, Chen H, Geng L, Bian Y. Effect of diethyl ether and ethanol additives on the combustion and emission characteristics of biodiesel-diesel blended fuel engine. *Renew Energy* 2011;36:1252–8.
- [4] Atmani A, Yuksel B, Ileri E, Karaoglan A. Response surface methodology based optimization of diesel-n-butanol-cotton oil ternary blend ratios to improve engine performance and exhaust emission characteristics. *Energy Convers Manag* 2015;90:383–94.
- [5] Martinez M, Sanchez N, Encinar J, Gonzalez J. Fuel properties of biodiesel from vegetable oils and oil mixtures. Influence of methyl esters distribution. *Biomass Bioenergy* 2014;63:22–32.
- [6] Labeckas G, Slavinskas S, Mazeika M. The effect of ethanol-diesel-biodiesel blends on combustion, performance and emissions of a direct injection diesel engine. *Energy Convers Manag* 2014;79:698–720.
- [7] Ozturk E. Performance, emissions, combustion and injection characteristics of a diesel engine fuelled with canola oil-hazelnut soap stock biodiesel mixture. *Fuel Process Technol* 2015;129:183–91.
- [8] Broatch A, Ruiz S, Margot X, Gil A. Methodology to estimate the threshold in cylinder temperature for self-ignition of fuel during cold start of diesel engines. *Energy* 2010;35:51–60.
- [9] Bergthorson J, Thomson M. A review of the combustion and emissions properties of advanced transportation biofuels and their impact on existing and future engines. *Renew Sustain Energy Rev* 2015;42:1393–417.
- [10] Ozener O, Yuksek L, Ergenc A, Ozkan M. Effects of soybean biodiesel on a DI diesel engine performance, emission and combustion characteristics. *Fuel* 2014;115:875–83.
- [11] Ileri E, Kocar G. Experimental investigation of the effect of antioxidant additives on NOx emissions of a diesel engine using biodiesel. *Fuel* 2014;125:44–9.
- [12] Yu L, Ge Y, Tan J, He C, Wang X, Liu H, et al. Experimental investigation of the impact of biodiesel on the combustion and emission characteristics of a heavy duty diesel engine at various altitudes. *Fuel* 2014;115:220–6.
- [13] Awad A, Loubar K, Tazerout M. Experimental investigation on the combustion, performance and pollutant emissions of biodiesel from animal fat residues on a direct injection diesel engine. *Energy* 2014;69:826–36.
- [14] Prakash R, Singh R, Murugan S. Experimental studies on combustion, performance and emission characteristics of diesel engine using different biodiesel bio oil emulsions. *J Energy Inst* 2015;88:64–75.
- [15] How H, Masjuki H, Kalam M, Teoh Y. An investigation of the engine performance, emissions and combustion characteristics of coconut biodiesel in a high-pressure common-rail diesel engine. *Energy* 2014;69:749–59.
- [16] Can O. Combustion characteristics, performance and exhaust emissions of a diesel engine fueled with a waste cooking oil biodiesel mixture. *Energy Convers Manag* 2014;87:676–86.
- [17] Sanli H, Canakci M, Alptekin E, Turkcan A, Ozsezen A. Effects of waste frying oil based methyl and ethyl ester biodiesel fuels on the performance, combustion and emission characteristics of a DI diesel engine. *Fuel* 2015;159:179–87.
- [18] Harch C, Rasul M, Hassan N, Bhuiya M. Modelling of engine performance fuelled with second generation biodiesel. *Procedia Eng* 2014;90:459–65.
- [19] Lesnik L, Iljaz J, Hribernik A, Kegl B. Numerical and experimental study of combustion, performance and emission characteristics of a heavy-duty DI diesel engine running on diesel, biodiesel and their blends. *Energy Convers Manag* 2014;81:534–46.
- [20] Chiriac R, Apostolescu N. Emissions of a diesel engine using B20 and effects of hydrogen addition. *Int J Hydrogen Energy* 2013;38:13435–62.
- [21] An H, Yang W, Maghbouli A, Li J, Chou S, Chua K, et al. Numerical investigation on the combustion and emission characteristics of a hydrogen assisted biodiesel combustion in a diesel engine. *Fuel* 2014;120:186–94.

- [22] Uludamar E, Yıldızhan S, Aydın K, Özcanlı M. Vibration, noise and exhaust emissions analyses of an unmodified compression ignition engine fuelled with low sulphur diesel and biodiesel blends with hydrogen addition. *Int J Hydrogen Energy* 2016;41:11481–90.
- [23] Karagoz Y, Sandalci T, Yuksek L, Dalkilic A. Engine performance and emission effects of diesel burns enriched by hydrogen on different engine loads. *Int J Hydrogen Energy* 2015;40:6702–13.
- [24] Baltacıoğlu M, Arat H, Özcanlı M, Aydın K. Experimental comparison of pure hydrogen and HHO (hydroxy) enriched biodiesel (B10) fuel in a commercial diesel engine. *Int J Hydrogen Energy* 2016;41:8347–53.
- [25] Agarwal AK. Biofuels (alcohols and biodiesel) applications as fuels for internal combustion engines. *Progress Energy Combust Sci* 2007;33:233–71.
- [26] AVL-BOOST Theory and AVL-BOOST Users Guide, <https://www.avl.com/ro/boost>.
- [27] Racovitza A, Radu B, Aldhaidhawi M, Chiriac R. On the possibility to reduce diesel engines emissions by operating with Biodiesel B20 in PPC mode. In: *Proceedings of the European Automotive Congress EAEC-ESFA*; 2015. p. 405–18.
- [28] Lahane S, Subramanian K. Impact of nozzle holes configuration on fuel spray, wall impingement and NOx emission of a diesel engine for biodiesel-diesel blend (B20). *Appl Therm Eng* 2014;64:307–14.
- [29] Valery C, Abbe N, Nzengeza R, Danwe R, Ayissi Z, Obonou M. A study on the 0D phenomenological model for diesel engine simulation: application to combustion of Neem methyl ester biodiesel. *Energy Convers Manag* 2015;89:568–76.
- [30] Petranovi Z, Vujanovi M, Duic N. Towards a more sustainable transport sector by numerically simulating fuel spray and pollutant formation in diesel engines. *J Clean Prod* 2015;88:272–9.
- [31] Aleiferis P, Rosati M. Controlled autoignition of hydrogen in a direct-injection optical engine. *Combust Flame* 2012;159:2500–15.
- [32] Autoignition temperatures in vehicle environments detailed results, <http://depts.washington.edu/vehfire/fuels/detailedresults.html>.