



Science Arts & Métiers (SAM)

is an open access repository that collects the work of Arts et Métiers Institute of Technology researchers and makes it freely available over the web where possible.

This is an author-deposited version published in: <https://sam.ensam.eu>
Handle ID: [.http://hdl.handle.net/10985/17722](http://hdl.handle.net/10985/17722)

To cite this version :

J. MORIN, Frédéric COLAS, Jean-Yves DIEULOT, S. GRENARD, Xavier GUILLAUD -
Coordinated control of active distribution networks to help a transmission system in emergency
situation - Energy Systems - Vol. 9, n°3, p.831-851 - 2018

Any correspondence concerning this service should be sent to the repository

Administrator : scienceouverte@ensam.eu



Coordinated control of active distribution networks to help a transmission system in emergency situation

J. Morin · F. Colas · J.Y. Dieulot ·
S. Grenard · X. Guillaud

Received: date / Accepted: date

Abstract This paper addresses the relevance of using reactive power from Medium Voltage (MV) networks to support the voltages of a High Voltage (HV) rural network in real-time. The selection and analysis of different optimal coordination strategies between the HV and several MV grids is investigated. The algorithms will control the reactive powers that can flow between HV/MV networks after a request from the Transmission Network Operator in case of an emergency situation such as a line outage. From a case study, the relevance of the coordination is enlightened and recommendations are given on how to tune and to combine the optimal algorithms with the advanced Volt Var Controllers of the distribution grids.

Keywords Distribution Network · Transmission Network · Optimal Control · Reactive Power Management · Smart Grids · Voltage Control

1 Introduction

When a line outage or an incident appears in a transmission grid, the Transmission System Operator (TSO) can take a number of actions such as redirect power flows by line switching (e.g. [1,2]). Along with the massive insertion of Distributed Generators in distribution grids, an alternative software based method would consist to control new degrees of freedom. Indeed, Distributed

J. Morin, F. Colas and X. Guillaud
Univ. Lille, Centrale Lille, Arts et Metiers Paris Tech, HEI, L2EP, Lille, France
E-mail: juliette.morin@ensam.eu

J.Y. Dieulot
Ecole Polytechnique Universitaire de Lille, CRISTAL, Lille

S. Grenard
Enedis, Paris. E-mail: sebastien.grenard@enedis.fr

Generators are able to supply or absorb reactive power [3,4], generating bidirectional power flows which in turn may mitigate voltages at the HV (High Voltage) side over or undershoots.

Whether and when a support of distribution grids to maintain the voltages at the HV side within their specification range is relevant remains an open question. Additionally, such a support would require to coordinate HV and MV (Medium Voltage) grids levers. HV and MV grid coordination is generally restricted to co-optimization studies for planning and dispatch (e.g. [5]), and does not address faulty events which occur in real-time.

Moreover, such gaps are not clearly pointed out by the new European Grid Code, Demand Connection (DCC) which only tries to decouple the behaviors of the transmission and each distribution grid at low active power consumption. Indeed, reverse reactive power flows from distribution grids may cause violations of specifications for voltages at the HV side [6,7] and the TSO may not be able to ensure a suitable regional power provision [8,9]. Hence, the European Grid Code requires that any new distribution system must prevent reactive power from flowing upwards the HV system at low active power consumption [10]. Notwithstanding, this paper proposes and discusses a variety of alternative and improved specifications and coordination strategies, as allowed by the DCC. An important issue is to provide an explicit cost-sharing method, which is, to our knowledge, not addressed elsewhere.

In the literature, HV/MV reactive power and HV grid voltage control with a contribution of distribution networks use uncoordinated strategies. The TSO can consider operations at the HV grid level where distribution networks are considered as fully controllable power plants or loads [11], and only co-simulation studies are developed to optimize the dynamic exchange of reactive power between a HV and MV grids, however not in real time [5]. This supervisor disregards constraints within the distribution networks (range of voltage at the MV side, the MV lines thermal constraints, the amount of reactive power that can be requested from Distributed Generators, etc.). An alternative consists of letting the DSO (Distribution System Operator) control the reactive power at the HV/MV interface, e.g. by adding a constraint either on the voltage at the HV side of the substation or on the reactive HV power exchange inside an optimal Volt Var Control (VCC) [4,12]. The relevance of this constraint with respect to the TSO needs have not been investigated, but pricing-based coordination schemes to dispatch active and reactive powers can be found in microgrids [13].

To sum up, in most real-time distribution grids VVCs, the transmission voltages are assumed to be stiff, which is questionable under degraded operating conditions [14] and when there exists a tighter interdependence between HV and MV grids [15]. In this case, a coordinated strategy, driven by the TSO, is likely to be more effective. Hence, this paper addresses the previous gaps mentioned above by considering a medium scale system involving a part of a HV network connected to several distribution networks, suffering a line outage. Generic conditions to assess the relevance of a reactive power support in case of voltage overshoot, or when a fault occurs are given in the first part. The

second part introduces the coordination structure, and shows that an optimal strategy, based on Optimal Power Flow (OPF) method, allows to consider explicitly cost-sharing (here, a trade-off between the reactive power required from MV grids and the HV system active power losses). Then, a brief account of the OPF (Optimal Power Flow) resolution is provided. From the case study, recommendations are given to select and tune an appropriate cost function. Not only the results of the case study show that the coordination scheme is effective to support **voltages at the HV side**, but also the behavior of the MV grids is investigated.

2 Relevance of HV grid reactive power support from MV grids

This section investigates the cases for which a reactive power support from the DSO to maintain the **voltages at the HV side** is effective, and shows that the short-circuit power is the key parameter. Hence, coordination between transmission and distribution grids will be of interest for weak grids or in default mode.

2.1 Weak HV grids and voltage to reactive power sensitivity

Traditionally, the voltage control in the Extra High Voltage (EHV) part of the French transmission system consists of a hierarchical three-level scheme [16]. However, the level of **voltages at the HV side** is only maintained by means of EHV/HV On Load Tap Changers(OLTC) in France. The voltage reference of the EHV/HV OLTC can be adjusted among the values $\{1.0, 1.02, 1.05\}$ to ensure that the **voltages at the HV side** remain within the specified contractual range $[0.92, 1.08]$ pu. In emergency situations, the TSO can request either a decrease by 5% of the HV/MV OLTC voltage reference to temporarily reduce the load demand, a deactivation of HV/MV OLTC that can contribute to boost voltage collapse, or load shedding of MV feeders. In the literature, it is expected that distribution networks can provide a reactive power support to help the TSO maintaining the **voltages at the HV side** within the contractual range. But one can wonder whether this support is relevant, and how the reactive power that should be requested from a given distribution network can be derived?

The effectiveness of a support from the MV networks highly depends on the HV grid parameters. Indeed, the influence of the reactive power from MV networks on the **voltages at the HV side** is roughly proportional to the short-circuit power S_{cc} . Actually, the reactive power flowing through a line without losses connecting two nodes is theoretically given by (in per unit):

$$Q_{1 \rightarrow 2} = -\frac{U_1 U_2}{X} \cos(\delta) + \frac{U_2^2}{X} \quad (1)$$

Differentiating equation (1) with respect to U_2 gives:

$$\frac{\delta Q_{1 \rightarrow 2}}{\delta U_2} = -\frac{U_1}{X} \cos(\delta) + 2\frac{U_2}{X} \quad (2)$$

Then assuming that $U_1 \simeq U_2, \delta \simeq 0$ and considering that $U_1 = 1$ pu is stiff leads to:

$$\frac{\delta U_2}{\delta Q_{1 \rightarrow 2}} \simeq \frac{X}{U_1} = \frac{1}{S_{cc}} \quad (3)$$

This equation gives the sensitivity of voltage to reactive power support depending on the short-circuit power. This influence is rather low for HV/MV substations with medium to high S_{cc} . Taking a realistic example, if $S_{cc} \geq 500$ MVA then $\frac{\delta V}{\delta Q} \leq 0.002$ pu/ **Mvar**. As a result, a reactive power support to maintain the corresponding voltage would turn out to be inefficient. However, considering weak distribution networks ($S_{cc} \leq 500$ MVA), typically rural ones, such a support could be worth considering. Moreover, HV/MV substation short-circuit powers can be highly impacted by disturbances such as line outage, for which a reactive support could be helpful.

2.2 A case study: a rural medium scale system

The system presented in **this section** verifies the low Short Circuit Power (S_{cc}) assumptions. It will be used throughout the paper to illustrate the coordination methodology. The topology of the grids are presented and the VVC of distribution grids briefly recalled. The reader is referred to [15] where these controls are detailed.

2.2.1 Distribution and transmission grids topology

Table 1: Short-Circuit Power S_{cc} of HV/MV substations

Substations	S_{cc} (MVA)
S1	407
S2	368
S3	2695
S4	206

The medium scale system considered in this work consists of several 20 kV distribution grids connected to a 63 kV grid as shown in Figure 1, which meets the conditions described in section 2.1. Indeed, the real distribution networks connected to this grid exhibit long feeders, and except from substation 3 which is very close to the EHV network (225 kV), their short-circuit powers are rather low (see Tables 1 and 5, more details in Appendix A). With such a

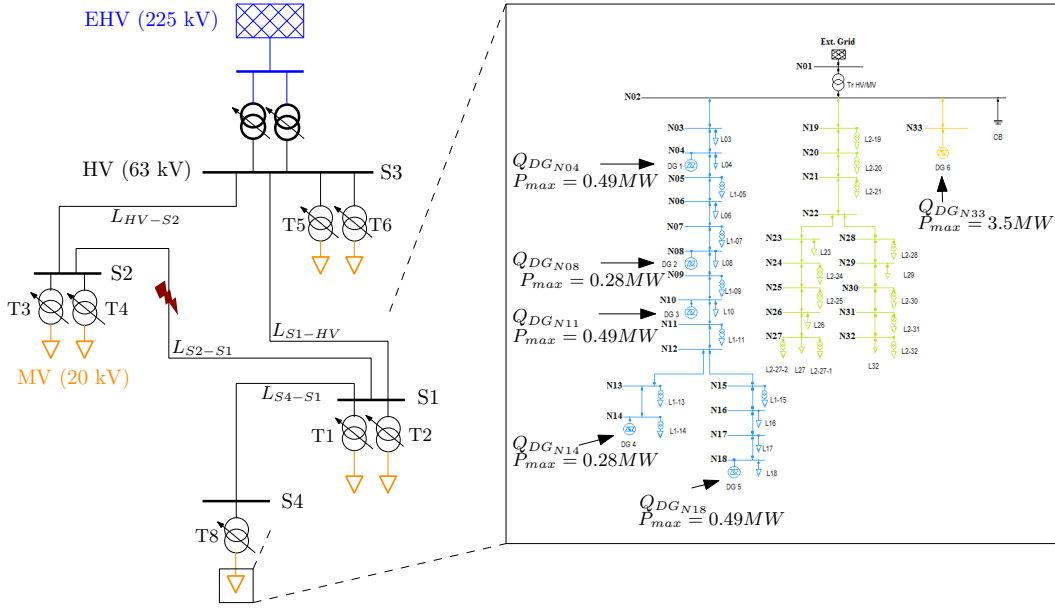

Fig. 1: The medium-scale system: several 20 kV distribution networks connected to a 63 kV grid

high level of underground cables in the distribution networks, high reactive power may flow upwards the transmission grid, especially at a low level of consumption. As a result, this transmission grid is prone to over-voltage and could face difficulties to manage the reactive power exchange at both HV/MV and EHV/HV interfaces, which justifies a TSO/DSO coordination.

Here, the 20kV grids follow a simplified topology which allows to ease the analysis of the control strategies [15]. Three types of feeders are connected to the grid, which are representative of different real configurations (within Figure 1, MV equipment corresponding to the network downstream transformer T_8 at substation S_4 is shown). One of them hosts only consumers, and the voltages are rather prone to under voltage (contrary to the two other types of feeders); a dedicated feeder embeds a high level of Distributed Generators production, while a "mixed" feeder has both production and consumption. Each HV/MV transformer is equipped with an OLTC that has 17 tap positions ($[-8, +8]$) with 1.5% voltage per tap. Parameters of the HV/MV transformer are given in Table 7 of Appendix A. At last, since this simplified model of a distribution network cannot reproduce the large amount of reactive power flowing upwards the transmission system (due to the high level of underground cables and long rural feeders) a load was connected at the secondary side of each substation to replicate the lines and cables contributions, and other equipment. Regarding the reactive power capacity of Distributed Generators, it is assumed that reactive power can be required in the range $[-0.35, +0.4]P_{max}$ at maximal active power injection.

2.2.2 Distribution grids control

The Distribution Network Control Center (DNCC) is a supervision center which is able to retrieve measurements (the powers flowing through the HV/MV substation, the active and reactive power injections of Distributed Generators, the voltages at the points of connection, and representative node voltages of the MV grids) and send references to actuators every minute. In France, such a communication system already exists, and the measurements are retrieved to the DSO control center in real-time for significant Distributed Generators ($> 1MW$) or after a **phone** request for smaller installations. It is assumed that the DNCC tools encompass a state estimator shown in Figure 2. Thus, the accuracy of voltages and power is assumed to be 0.5% and 1% respectively that allows to set up advanced real-time VVC strategies. The Distributed Generators are not fully controlled by the DSO, they should only follow reactive power references provided by the DSO.

One of the contributions of the paper is to analyze the behavior of distribution grids with advanced VVC strategies under an optimal cooperation supervised by the transmission grid. Among the different VVC algorithms, Model Predictive Control (MPC) has shown its remarkable ability to distribute the control effort among many actuators and to deal with actuator delays, nonlinearities and known disturbances [4,12,15]. A first objective of the controller is to maintain the **voltages at the MV side** within a specified range of values ($[0.95, 1.05]$ pu herein). Then, the reactive power exchange flowing through the HV/MV substation should be limited by maintaining the ratio of reactive power consumed by the MV grid over the active power consumed below a threshold value: $\tan_{HV-MV} = \frac{Q_{HV-MV}}{P_{HV-MV}} \leq \tan_{max}$. **At each k^{th} sampling time, the Model Predictive Control algorithm finds the sequence of controls $u(k)..u(k+N-1)$ that minimizes the criterion $J(k)$ given in equation (4) over a receding horizon, while respecting constraints on the actuators and the state. The specified range of the controlled variables and the physical limitations of actuators are given in equation(5). The future states of the system $x(k+1) \dots x(k+N)$ are anticipated through a prediction model.**

$$\min(J(k))_{u(k) \dots u(k+N-1)} = \sum_{i=0}^{N-1} [\Delta u(k+i) R \Delta u(k+i)^T] + u(k+i) S u(k+i)^T. \quad (4)$$

$$\forall i, k \leq i \leq k+N-1,$$

$$\begin{aligned} V_{min} &\leq V(i) \leq V_{max}, \\ \tan_{min} &\leq \tan_{MV \rightarrow HV}(i) \leq \tan_{max}. \\ u_{min} &\leq u(i) \leq u_{max}, \Delta u_{min} \leq \Delta u(i) \leq \Delta u_{max}. \end{aligned} \quad (5)$$

The control variables $u(k) = [V_{OLTC \text{ ref}}, Q_{DG \text{ ref}}, n_{CB \text{ ref}}]$ **at each iteration level**, k are the tap position of the OLTC (through the voltage reference of the HV/MV OLTC), the reactive power reference of Distributed Generators and

the number of activated steps of Capacitor Banks. The first part of the criterion $J(k)$ penalizes the actuation changes between two consecutive instants $\Delta u(k+i) = u(k+i+1) - u(k+i)$, weighted by matrix R . The weights in the matrix R can be higher when the actions are expensive (e.g. tap changes) than when actions are cheap (e.g. calling for reactive power, which is considered as costless in this work). The second part of the criterion penalizes the level of control effort with a weighting matrix S . This control effort is either the amount of reactive power $Q_{DG\ ref}$ requested from the Distributed Generators or the number of activated steps $n_{CB\ ref}$ of Capacitor Banks. Note that there is no cost associated to the OLTC tap position, which means that the corresponding coefficients in matrix S are set to zero (i.e. only the tap position variation is penalized). The variables have been normalized and the non zero coefficients of S and R set to 1.

Loss minimization could have been easily included in the cost function $J(k)$. However, it is usually considered at the design stage of the network or indirectly by the VVC scheme enforcing the voltages to remain around a limited range of values [17]. Moreover, it is difficult to assess the true gain yielded, because a model of the losses expectation, to be incorporated in the predictive scheme, depends on the load model which is plagued with high uncertainties [4].

As said before, a model able to predict future states is mandatory. This model

is based on sensitivity matrices, $\frac{\delta x}{\delta u}$, $x = [V, Q_{HV-MV}, P_{HV-MV}]$ which are evaluated once and for all assuming a constant load model while loads have been modeled differently in the simulations. These matrices are not updated during the simulations, but, as already assessed in [17], inaccuracies in the model can be partially handled by the closed-loop nature of **Model Predictive Control**. In addition to this model, a nonlinear model of the OLTC is given [4]. In order to prevent control failures, a hierarchical relaxation of the constraints has been designed using slack variables that should be heavily penalized inside the objective function [4, 15]. They enforce the control to prioritize the constraint on **voltages at the MV side** over the reactive power exchange one. The Mixed Integer Non Linear Programming solver "BNB" of the Matlab toolbox YALMIP [18, 1], based on branch and bound techniques, has been used to handle both integer and continuous variables (for a comprehensive description, see [15, 4]). **Finally**, it is assumed that this VVC scheme set up in accordance with the network design (grid reinforcement and development) will be activated only for emergency cases, where the priority is given to the respect of the constraints at minimal DSO control effort cost. To sum up, one of this predictive VVC controller main interests is to yield an optimal sequence of control effort that maintains the voltages in a specified range while assigning limitations to the reactive power exchange at the TSO-DSO interface. These performances will prove to be useful for situations which will be investigated hereafter, where a reactive power support from MV grids is required.

3 Optimal TSO-DSO coordination

This section describes the structure, algorithm and the merits of an optimal coordination for cost-sharing between the distribution and transmission grids.

3.1 Coordination structure

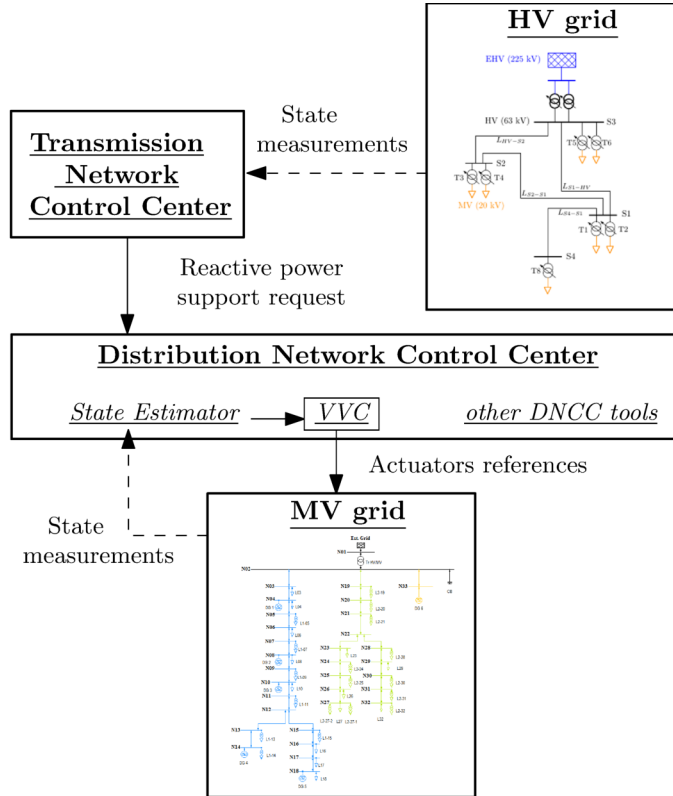

Fig. 2: Schematic of the proposed control

Figure 2 describes a hierarchical control structure where an upper control layer located in the Transmission Network Control Center generates and coordinates the references of HV levers with MV reactive power flows from the distribution grids. The lower layer consists of the distribution grid VVC described in section 2.2 which both have to maintain their own voltages within prescribed bounds and track the reactive power references. This part deals with the upper control layer. **This layer considers several control inputs** within the HV system, which are the reactive power references (Q_{HVref}) of possible

existing voltage levers connected to the HV system (e.g. shunt reactances, Distributed Generators, Tap stagger technique using the EHV/HV OLTC) and the voltage reference of the OLTC of EHV/HV transformers ($V_{HV,ref}$). These levers should be coordinated with the reactive power requests ($Q_{HV \rightarrow MV,ref}$) at the HV/MV system interfaces. The main objective of this coordination is to correct the **voltages at the HV side**.

Currently, such a coordination or such a reactive power support is not found in the literature. The European regulations (DCC) only forbid reactive power to flow upwards the HV-MV interface at low active power consumption [10], but allow to consider new schemes should they improve the grid operations. Indeed, a good coordination can achieve secondary objectives which are quite relevant for the TSO. For example, **it is possible** to require that the distribution grid absorb more reactive power to decrease the reactive power exchange at the EHV/HV interface, as **voltages at the EHV side** are very sensitive to reactive power flows) and to take the reactive power limitation of each MV grid into account.

The coordination strategies require that the TSO is able to send a reactive power request to the DSO in case of urgent need (in the example, a line outage). In turn, the DSO should be able to activate the HV-MV reactive power constraint in order to try to meet this demand. The communication scheme between the reactive power management and the VVC of active distribution networks, performed in a Transmission Network Control Center, is depicted in Figure 3. As will be shown in section 3.2, the coordination will try to obtain the cheapest solution by solving an Optimal Power Flow (OPF).

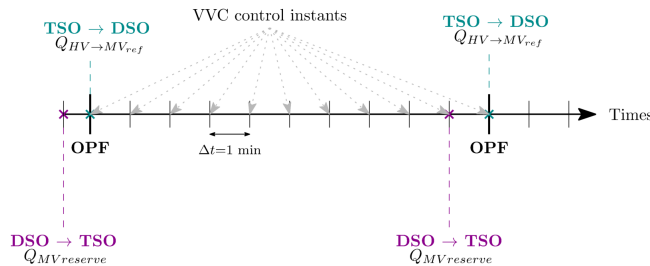

Fig. 3: Association of the Optimal Power Flow strategy with the VVC of distribution grids

Every 10 minutes, the resolution of the **Optimal Power Flow** problem yields the reactive power references to be tracked at the HV/MV interface by the VVCs. To perform the **Optimal Power Flow** studies, the TSO uses the latest available measurements of the **voltages at the HV side** and the power flows at the MV busbar of the HV/MV substations. It is also assumed that the DSO has sent to the TSO a forecast of the reactive power reserve for the next 10 minutes (this interval sticks to industrial conditions, while a smaller sampling time on the MV side allows to implement hierarchical control). Then, after

the TSO has called for the optimal reactive power support from the DSO, the VVCs act every minute in order to enforce a suitable profile of **voltages at the MV side** and try to meet an appropriate reactive power at the HV/MV interface. At the end of the 10 minutes horizon, the DSO sends the new forecast of the reactive power reserve. Next, if the constraints on the **voltages at the HV side** or EHV/HV reactive power are not met, new references of HV/MV reactive power exchanges are to be set by the TSO.

3.2 Optimal strategies for cost-sharing

When an incident occurs, or when the **voltages at the HV side** are low, the TSO can coordinate its own levers with a reactive power support from the MV grids. This coordination with several distribution systems can be done using different strategies, and, for example, it is possible to draw a set of rules to generate the HV and MV control references. However, any method should try to obtain the cheapest solution and verify the load flow equations. Hence, the selected coordination algorithm is an **Optimal Power Flow (OPF)** method which minimizes the cost described in equation (6). This cost consists of a trade-off between the reactive power support from MV grids and the active power losses within the HV system (including the HV/MV transformers). The key parameter α corresponds to a weighting factor between those costs. The value of α should be tuned on a win-win contractual basis and a thorough sensitivity study that will be given in section 4. Hence, the **Optimal Power Flow (OPF)** algorithm proposed in this paper is both original and relevant as it addresses fairly the cost sharing of control of **voltages at the HV side**.

$$J_{OPF} = (1 - \alpha)|Q_{HV \rightarrow MV_{ref}}| + \alpha P_{Loss}. \quad (6)$$

Another advantage of OPF methods is their ability to handle multiples objectives and complex constraints or models, which are embedded into the optimal problem. The main control specifications are to enforce that the **voltages at the HV side** remain in a prescribed range (7). Since **loads are represented with a constant power model, the active and reactive power consumed** by the MV grids is assumed to be independent of the OPF solutions (and the actions of the considered levers) and that these powers remain constant between two control actions (i.e, after two control references yielded by the OPF (every 10 minutes) and sent to the MV grids VVC, the **voltages at the HV side** are corrected). The HV/MV OLTCs are included within the model in order to incorporate the iron and Joule losses within the HV/MV OLTC.

$$V_{HV_{min}} \leq V_{HV} \leq V_{HV_{max}}. \quad (7)$$

The other constraints are the load flow equations, along with HV actuators $U = [Q_{HV \rightarrow MV_{ref}}, Q_{HV_{ref}}, V_{HV_{ref}}]$ physical and rate limitations:

$$U_{min} \leq U \leq U_{max}; \Delta U_{min} \leq \Delta U \leq \Delta U_{max}. \quad (8)$$

So far, the optimization problem embeds only specifications for the **voltages at the HV side (7) with HV constraints**. Additional specifications can be considered, as mentioned in section 3.1. One of them consists of bounding the reactive power exchange at the EHV/HV systems interface (**OPF with HV and EHV constraints**). As an alternative, a different additional specification consists of preventing reactive power export upwards the HV grid (**OPF with DCC constraints**), which is in compliance with the standard European code requirements. According to the needs of the TSO, one out of these problems can be selected. A comparison between these three problems is given in section 4 to only comply with the DCC requirements as a standard basis for comparison purposes. The three different OPF and their specification sets are summarized below:

- **Optimal Power Flow with HV constraints** $\rightarrow C_{V_{HV}}$: Correct the **voltages at the HV side** only;
- **Optimal Power Flow with HV and EHV constraints** $\rightarrow C_{V_{HV}, Q_{EHV-HV}}$: Correct the **voltages at the HV side** and, as an additional objective, bound the reactive power exchange at EHV/HV systems interface;
- **Optimal Power Flow with DCC constraints** $\rightarrow C_{V_{HV}, Q_{HV-MV}}$: Correct the **voltages at the HV side**, and given the loading condition ($P_{EHV-HV} > P_{max}$), no export upwards the HV grid is authorized).

3.3 **Optimal Power Flow** resolution and discussion

The optimization problem is unusual in that it exhibits a criterion and control levers that involve both distribution and transmission systems operators. The optimization algorithm, is however quite classical. The algorithm active-set of the Matlab routine `fmincon` is suitable to handle constrained nonlinear multivariable optimization. A nonlinear model of the HV system is required to perform the optimization, which consists of:

- EHV/HV stations with OLTC transformers;
- HV lines and cables;
- HV/MV substations with OLTC transformers;
- Constant power loads that embody the MV grids, connected to the MV busbar of HV/MV substations;
- Constant power loads with adjustable reactive power that represent the distribution grid reactive power reserve at the MV busbar of HV/MV substations.

The HV and MV models were developed on a specific software (RAMSES, University of Liege, using the phasor approximation) and the real-time interface with Matlab, which handles the optimization algorithm and the distribution grids advanced VVCs, is described in detail in [15].

Regarding the MV grids constraints, the reactive power limit that can be required from the MV grids depends upon the voltage at the primary side of the HV/MV substation. Without coordination, the DSO and TSO can take conflicting actions. As an example, the DSO can require reactive power available downstream the substation to lower voltages at the MV side, but, depending on the short-circuit power of the substation, this will also decrease the voltage at the primary side (HV busbar of the substation). In turn, the TSO will take a corrective action by acting on the the HV/MV OLTC to increase the voltages at the HV side (up to their contractual limit in order to decrease losses), hence increasing the voltages at the MV side again. After a few iterations of this uncoordinated sequence, the HV/MV OLTC will be saturated and there will be no more uncoupling between the voltages at the MV side and the HV side. In this case, more and more reactive power from the Distributed Generators connected to the MV grid will be requested. To sum up, coordination is mandatory to solve conflicts and avoid inappropriate situations as OLTC saturations. An appropriate coordination can ensure that the reactive power references obtained by the resolution of the Optimal Power Flow will not endanger the enforcement of suitable profiles of voltages at the MV side. It will be assumed that the MV networks are able to provide their reactive power reserve depending on the voltages at the HV side at the HV busbar of the HV/MV substation.

The proposed coordination strategy is based on a centralized algorithm which solves an optimal problem based on explicit cost-sharing between the TSO and the distribution grid operators. In itself, such a coordination is original, and it further allows to consider other specifications than HV support (e.g. EHV grid support). Optimality is a true advantage over distributed approaches, which do not consider the common good, or algorithms which embed heuristic rules. Other optimization algorithms, based for example on multi-agents, could of course be used to solve the optimization problem. However, a complicated and time-consuming solution is not necessary in the context of problem with a reasonable number of variables.

4 Case study: relevance of a MV reactive power support in case of a HV line outage

4.1 Description of the case study operating point and simulation

Section 4.1 aims to illustrate the relevance of the proposed DSO-TSO coordination. More specifically, the relevance of using a reactive power support from MV grids in case of a line outage is studied. The proposed case study is based on the grid illustrated in Figure 1. This medium scale system has been entirely designed with the software RAMSES of the University of Liège [19] while the VVC controller is designed and called for using Matlab. The control structure and communication links are detailed in Figure 2. The initial voltages, active

and reactive power flows at the primary side of the HV/MV substations are detailed in Table 2 and in Figure 4. From this table, one can observe that the system is at low loading conditions and with high production level. This section aims to illustrate the relevance of the proposed DSO-TSO coordination. More specifically, the relevance of using a reactive power support from MV grids in case of a line outage is studied. However, the voltages at the MV side and voltages at the HV side are within the suitable respective range of values. Regarding the distribution networks, two OLTCs (T_2 and T_8) have reached their saturation point. In case of a disturbance further increasing the voltages at the HV side would therefore lead to an overshoot in voltages at the MV side downstream these two specific transformers. Hence, support from Distributed Generators is necessary to be able to correct the corresponding MV grids voltage profiles. Moreover the voltage reference of EHV/HV transformer is equal to 1.00 pu and cannot be further decreased.

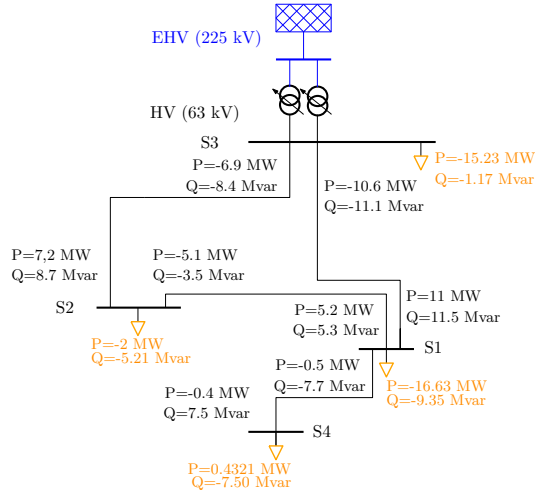

Fig. 4: Load flow conditions after the line outage

The simulated event is an outage of the line L_{S2-S1} which will consequently lead to an overshoot of the voltages at the HV side at the substations S_1 , S_2 and S_4 while the voltage at S_3 is barely altered. At the same time, the sensitivity of the voltages at the HV side with respect to the MV reactive power flows will increase.

Table 2: Initial voltages, active and reactive consumption at the primary side of HV/MV substations, and voltages V_{final} after the line outage

Substations	$V(pu)$	$V_{final}(pu)$	$P(MW)$	$Q(Mvar)$
$S1$	1.0541	1.0744	-16.63	-9.15
$S2$	1.0388	1.0174	-2.00	-5.21
$S3$	0.9951	0.996	-15.23	-1.17
$S4$	1.0722	1.0941	0.4321	-7.50

4.2 Recommendation for the definition of a relevant cost function for optimal algorithms

As a first step, only the upper level of the coordination is studied, e.g. the three aforementioned **Optimal Power Flow** at the TSO level, and off-line, in order to set properly **their parameters**, before considering the whole hierarchical control. As a consequence, in this subsection, only static results are presented without considering the MV grids control and limitations.

Figure 5 gives the total amount of reactive power obtained for each simulation (considering the steady-state regime) depending on the cost function that has been selected, while Figure 6 compares the active losses level within the HV system.

From the results of Figure 5, obtained with several values of $0 \leq \alpha \leq 1$, defined in equation 4, the needs in MV reactive power reserve shoot up when tightening the constraints on the reactive power flows within the HV system. As a reminder, when $\alpha = 1$, the objective is the minimization of the MV grid reactive power support. The DCC requirements corresponding to Set 1 (embodied by the black curves) is the most demanding case regarding the reactive power reserve. For instance, comparing the results obtained with $J_{(\alpha=0)}$, there is a difference in the total amount of MV reactive power support of 18.7 **Mvar** when enforcing no EHV/HV reactive power export, and of 23.9 **Mvar** when enforcing the DCC requirements (no reactive power export at HV/MV interface). The reactive power effort required from MV grid is immoderate when considering the losses minimization only ($J_{(\alpha=1)}$), or when too hard constraints on the reactive power flows within the HV system are required. When considering $\alpha = 1$, and without constraints on the HV reactive power flows (set of constraints $C_{V_{HV}}$ embodied by the violet curves) the need of a MV reactive power support is quite increased. From Figure 5, considering the set of constraints $C_{V_{HV}}$, there is a difference in the total amount of MV reactive power support of 27.6 **Mvar** between $J_{(\alpha \leq 0.8)}$ and $J_{(\alpha=1)}$, and this difference starts to decrease when α is above 0.8. Hence, minimizing only the active losses while disregarding the cost of using the MV reactive power reserve is an irrelevant strategy.

It should be noted that in any cases, the active losses after the corrective process are below the initial value of 1.18 MW (See Figure 6). Next, the more the reactive power is constrained, the less the active losses can be decreased. Indeed, there are no significant differences in the level of active losses reached

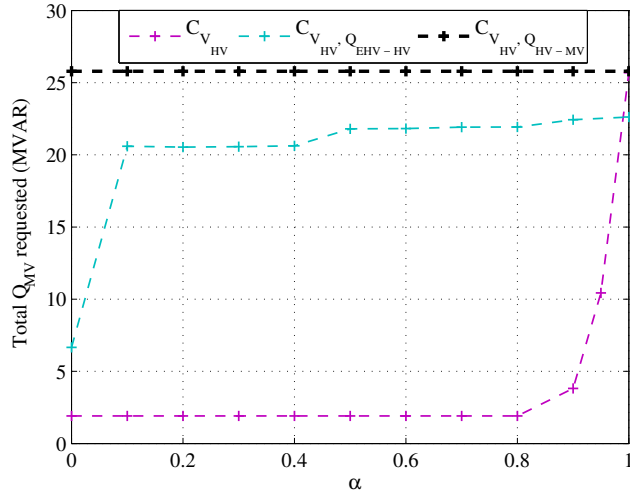

Fig. 5: Total amount of requested reactive power, OPF with DCC constraints black, OPF with HV constraints purple, OPF with HV and EHV constraints blue

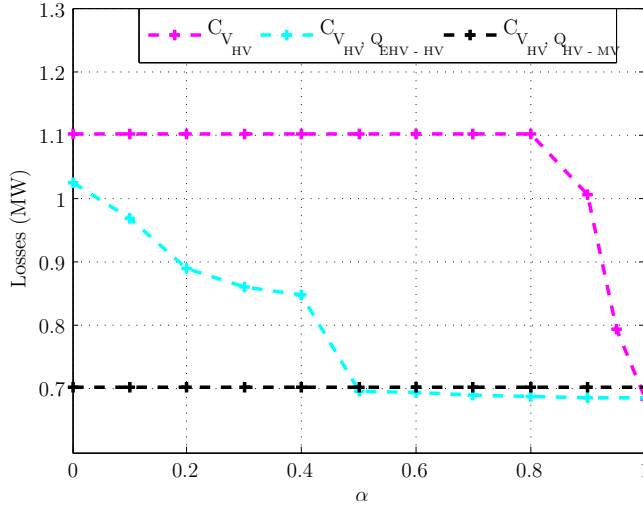

Fig. 6: Active losses within the medium-scale system, OPF with DCC constraints black, OPF with HV constraints purple, OPF with HV and EHV constraints blue

with several value of α in the objective function $J_{(0 \leq \alpha \leq 1)}$ and either the set of constraints $C_{V_{HV}, Q_{HV-MV}}$ or $C_{V_{HV}, Q_{EHV-HV}}$.

Considering the first set of constraints $C_{V_{HV}}$ (where the constraints are only on the voltages at the HV side), the objectives of minimizing either the reactive power requested from MV grids and the HV system active losses are quite antagonistic. However, the differences are small when the constraints $C_{V_{HV}, Q_{HV-MV}}$ are activated. To sum up, in order to define an appropriate

coordination between TSO and DSO, it is necessary to negotiate a trade-off for the common good, while a moderate effort should be requested from the MV grids. From the results, the minimization of active losses only is not relevant especially if it is considered that the MV grid support is required for safety and voltage stability purposes. The proposed voltage control, at the TSO level, can be somehow considered as a tertiary voltage control, enabling the TSO operators to restore the level of the voltages at the HV side. It can be observed from figures 5 and 6 that, in our case study, the range $\alpha \in [0.5, 0.8]$ is a good trade-off for the two objectives as the requested reactive power and the losses remain approximately constant. In the sequel and from this empirical analysis, we have arbitrarily chosen $\alpha = 0.5$.

Now that the Optimal Power Flow parameters have been tuned, dynamic simulations on the medium scale system can be performed to investigate the performance of the whole hierarchical coordination : Optimal Power Flow (OPF) + VVC. Next, only OPF with HV constraints and OPF with HV and EHV constraints will be further investigated.

4.3 Impact of the TSO-DSO coordination on the transmission system

This subsection focuses more specifically on the results obtained at the HV level. Nevertheless, the VVC of MV grids are active as explained in 4.4. As a reminder two Optimal Power Flows (OPF) have been considered : OPF with HV constraints and OPF with HV and EHV constraints. They are further compared with a case without constraint (no OPF e.g. no request from TSO). In Optimal Power Flow with HV and EHV constraints, the desired reactive power target at the EHV/HV interface has been set to -15 Mvar as this is a sensitive constraint than can be reached only by using the reactive power of Distributed Generators connected in the MV grid. Regarding the voltages at the HV level, they should be maintained within the contractual range of values $[0.92 - 1.08]$ pu.

The three aforementioned control schemes (OPF with HV, EHV and HV, DCC constraints) are further studied and compared in the case of the outage of the line Ls2-s3. As a reminder, the MV grids are equipped with a Model Predictive Control VVC.

Figure 7 shows the voltages at the HV side obtained for the three cases, while, for the sake of readability, Figure 8 gives the reactive power exchange downstream each HV/MV transformer for only the unconstrained (no OPF) case and the OPF with EHV/HV reactive power constraint. The line outage occurs at $t = 10$ s. As a result, an overshoot in the voltage at the HV side occurs: S_4 voltage level reaches 1.0923 pu. The Model Predictive Controllers are activated at $t = 80$ s and then act every minute until the constraints are enforced. Only the voltage of the MV grids downstream S_1 , S_2 and S_4 are impacted by the disturbance while S_3 is barely altered. However, it should be noted that the voltage at S_2 decreases after the disturbance but remains

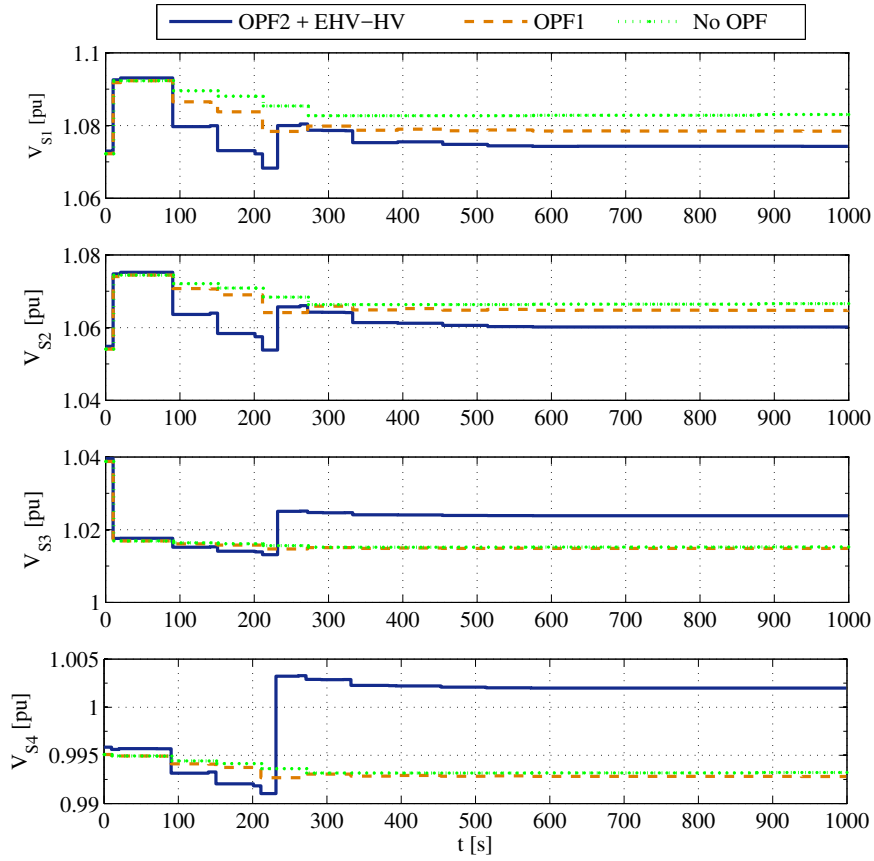

Fig. 7: Comparison of the evolution of voltages at the HV side

within contractual ranges, which in turn will not induce any voltage constraint violation at the MV level downstream S_2 .

The main lessons are the following:

- The unconstrained algorithm is unable to bring back V_{S4} and this case can be considered as a failure and justifies the use of coordinated algorithms. Nevertheless, distribution networks VVCs naturally tends to correct the voltages at the HV side. Indeed, VVCs request reactive power from Distributed Generators connected to the MV grid to correct the voltages at the MV side, and indirectly decrease the voltages at the HV side, even when OLTCs reach their saturation point.
- Both OPF with HV constraints and OPF with HV and EHV constraints reach their objectives (correction of voltage and reactive power). Since an OPF with HV and EHV constraints requests a more significant reactive power support, the correction of the voltages at the HV side is even faster.

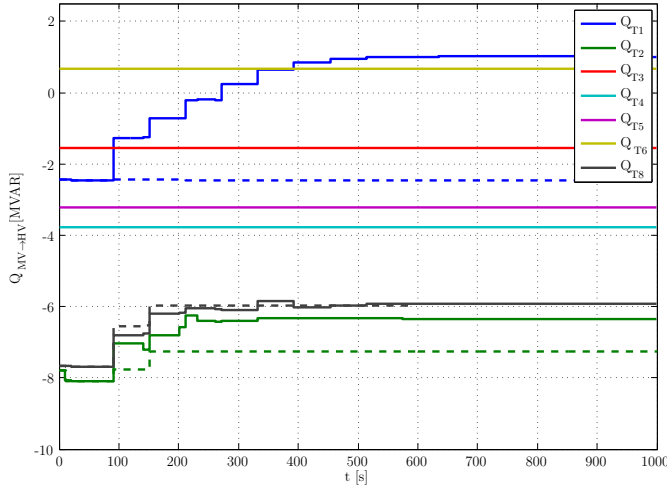

Fig. 8: Comparison of the evolution of the reactive power flowing through HV/MV transformer at HV side, no OPF, dotted lines, OPF +EHV-HV solid lines.

- There are cross-sensitivities between the **voltages at the HV side** and the reactive power of HV/MV substations. It can be noticed that calling reactive power from S_4 induces a modification of the voltages of low S_{cc} substations.

Table 3 compares the results obtained with the uncoordinated and the Optimal Power Flow-based reactive power management. Keeping in mind that the uncoordinated strategy fails to recover all voltages, the **Optimal Power Flow** strategy allows to save 0.039 **Mvar** while triggering no additional tap changes, and distributes correctly the reactive powers. When an EHV constraint is activated, an overprice should be paid as, actually, more reactive power should be requested. However, it shows that, when necessary, the TSO may send a request that will grant a help from the DSO for EHV stability at a reasonable cost, which an uncoordinated algorithm is unable to perform.

Table 3: Comparison of the reactive power requested from Distributed Generators and HV/MV OLTCs with the rule-based and the Optimal Power Flow reactive power management

Association	Q_{T_i} (Mvar)				Tap changes
	Q_{T1}	Q_{T2}	Q_{T7}	Q_{Total}	
Uncoordinated strategy	0.177	0.837	1.73	2.744	5
OPF - HV	0	0.8016	1.9035	2.705	5
OPF HV-EHV	3.448	1.7399	1.7499	6.9378	7

4.4 Impact of the TSO-DSO coordination on the distribution system

It has been shown in section 4.3 that the combination of the **Optimal Power Flow** strategy and the predictive VVCs was suitable to maintain appropriate profiles of the **voltages at the HV side**, and section 4.4 wants to illustrate that the results also meet the specifications from the MV side. It is chosen to show only one representative result at the MV side of coordination between the HV and MV grids, namely when the reactive power constraint is enforced at the EHV-HV interface. The **Model Predictive Controller** is able, for every MV grid, to steer the **voltages at the MV side** inside the specified range and to track a HV-MV reactive power reference. **Distribution system behavior is presented in Figure 9 where V_{MV} , $\max(V)$, $\min(V)$, V_{max} are respectively the substation voltage, the maximum and minimum observed voltages at the MV side and the maximum allowable voltage at the MV side set to 1.05 pu.** As can be seen in this Figure 9, the convergence is exponential, and the predictive controller can handle multiple inputs. Such an advanced controller is useful, because it is able to bring out a fast response to the optimal references generated by the HV grid supervisor, which might not be the case for simplistic control algorithms. Hence, in a general way, the behavior at the MV side has always been shown to be successful. The **Model Predictive Controller** activation, which is changing every minute, can be seen in Figures 7, 8, 9; for a more detailed description, see [15].

The only limitations come from unwanted tap operations at the MV side may occur, as can be seen from the results downstream the transformer T_2 which are shown in **Figure 9**. A tap change up is immediately followed by a tap change down around $t = 140$ s, because the predictive VVC is unable to anticipate the true evolution of the **voltage at the HV side** of the substation S_1 (and thus of the profile of the **voltage at the MV side**). Indeed, the evolution of V_{S_1} is partly tied with the evolution of the HV/MV reactive power exchanges within the HV system. Since the short-circuit power of S_1 is rather low, and non negligible reactive power support are requested from the other networks, more specifically downstream T_1 , T_2 and T_8 , unsuitable tap changes are triggered. A very simple way to correct these inappropriate actions would be to use a predictive **Optimal Power Flow** at the HV side. However, it would require extra communication, and, more precisely, data exchange between distribution and transmission grid controllers.

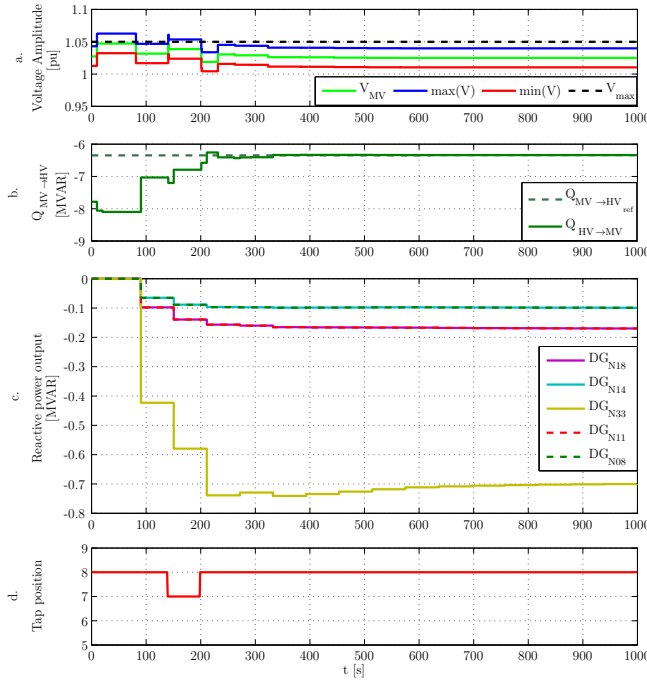

Fig. 9: Focus on the results of the MV grid downstream T_2 to illustrate the issue of inappropriate tap operations

5 Conclusion

In this paper, an optimal reactive power support to High Voltage network from Medium Voltage networks, activated by the Transmission System Operator in case of emergency, was made possible by combining HV levers with a constraint on the HV/MV reactive power exchange. For weak and non-stiff distribution networks, namely rural networks that exhibit low short-circuit powers S_{cc} , the reactive support is non negligible to mitigate the rises of the voltages at the HV side. As a result, by adjusting the reactive power injection of Distributed Generators to correct the voltages at the MV side, distribution systems VVC schemes naturally and indirectly tend to help correcting the voltages at the HV side.

The optimal strategy consists of balancing the MV reactive power support and the active power losses within the HV system, which should be done on a contractual win-win basis. It was shown that a coordinated strategy was mandatory. Indeed, the Optimal Power Flow steers the voltages at the HV side into their specified range, whereas an uncoordinated was not able to do, at the lowest cost. The optimal strategy generally consists of requesting a moderate effort from the MV grids, under the conditions that the active power losses are not too degraded. The algorithm is also able to handle such issues as the lack of reactive power reserve or allowing to reach secondary objectives.

Specifically, it has been shown that controlling the reactive power exchange at EHV/HV interface helps to guarantee the voltage stability of the transmission system at a very reasonable reactive power cost for the DSO as voltages at the EHV side are sensitive to reactive power flows. In a way, the MV grids are providing an ancillary service to the TSO by contributing to maintain the voltage and the reactive in a suitable range of values.

The distribution grids, when controlled by an advanced (here model predictive) algorithm, are able to maintain their own voltages within the specified range while delivering the adequate level of reactive power to the transmission grid. During the corrective process, the reactive power of Distributed Generators, the voltage reference of HV/MV On Load Tap Changer and the switching statuses of Capacitor Banks are adjusted by the distribution grid VVC. Still, some cross-sensitivities due to the lack of anticipation of the optimal algorithm may generate inappropriate tap changes.

Mainly, this work opens the doors for more coordination and negotiation between TSO and DSO, for their common good and for the customer's profit.

A HV and MV networks parameters

Table 4: HV Lines parameters

Line	R (Ω)	X (Ω)	WC/2(μS)	S_{nom} (MVA)
L_{HV-S2}	5.94	14.487	22.462	189
L_{S2-S1}	5.168	8.925	30.00	189
L_{S4-S1}	4.452	10.39	37.542	189
L_{S1-HV}	6.216	13.796	49.48	189

Table 5: Details of lines and cables distribution in MV grids

Substations	Average feeder length (km)	Overhead lines total length (km)	Underground cables total length (km)
$S1$	20.54	314.82	284.85
$S2$	21.61	397.31	180.50
$S3$	24.42	457.05	223.26
$S4$	31.18	331.60	240.76

Table 6: HV Transformers' parameters

Transformers	V_{1nom} (kV)	V_{2nom} (kV)	R (%)	X (%)	S_{nom} (MVA)
T_9, T_{10}	225	63	0.232966	11.99774	70

Table 7: MV Transformers' parameters

Transformers	V_{1nom} (kV)	V_{2nom} (kV)	R (%)	X (%)	S_{nom} (MVA)
T_1, T_2	63	21	0.06125049	18.742400775	36
T_3, T_5, T_6	63	21	0.0826875	13.229746425	20
T_4	63	21	0.0937125	13.22966925	20
T_8	63	21	0.052062255	13.229900775	36

References

1. S. Frank, I. Steponavice, and S. Rebennack, "Optimal power flow: a bibliographic survey I Formulations and deterministic methods," *Energy Systems*, vol. 3, pp. 221–258, 2012.
2. K. Schumacher, R. Li-Yang Chen, and A. Cohn, "Transmission expansion with smart switching under demand uncertainty and line failures," *Energy Systems*, vol. 8, pp. 549–580, 2017.
3. J. Morin, F. Colas, X. Guillaud, and S. Grenard, "Determination and origins of reactive power flows in HV/MV substations," in *23rd International Conference and Exhibition on Electricity Distribution (CIRED 2015)*, 2015.
4. J. Morin, F. Colas, J. Dieulot, S. Grenard, and X. Guillaud, "Embedding oltc nonlinearities in predictive volt var control for active distribution networks," *Electric Power Systems Research*, vol. 143, no. Supplement C, pp. 225 – 234, 2017.
5. V. Krishnan, J. Ho, B. F. Hobbs, A. L. Liu, J. D. McCalley, M. Shahidehpour, and Q. P. Zheng, "Co-optimization of electricity transmission and generation resources for planning and policy analysis: review of concepts and modeling approaches," *Energy Systems*, vol. 7, pp. 297–332, May 2016.
6. L. Chen, H. Li, V. Turnham, and S. Brooke, "Distribution network supports for reactive power management in transmission systems," in *2014 IEEE PES Innovative Smart Grid Technologies, Europe (ISGT Europe)*, pp. 1–6, IEEE, 2014.
7. M. Constantin, M. Eremia, and L. Toma, "Comparative analysis between conventional voltage control using reactors and continuous voltage control using TCR in the Romanian transmission grid," in *PowerTech, 2013 IEEE Grenoble*, pp. 1–6, June 2013.
8. P. Cuffe, P. Smith, and A. Keane, "Capability Chart for Distributed Reactive Power Resources," *IEEE Transactions on Power Systems*, vol. 29, pp. 15–22, Jan 2014.
9. P. Goergens, F. Potratz, M. G?dde, and A. Schnettler, "Determination of the potential to provide reactive power from distribution grids to the transmission grid using optimal power flow," in *Universities Power Engineering Conference (UPEC), 2015 Proceedings of the 50th International*, pp. 1–6, 2015.
10. ENTSO-E, "Network Code on Demand Connection," tech. rep., 2012.
11. M. Zerva and M. Geidl, "Contribution of active distribution grids to the coordinated voltage control of the Swiss transmission system," in *Power Systems Computation Conference (PSCC)*, pp. 1–8, 2014.
12. G. Valverde and T. Van Cutsem, "Control of dispersed generation to regulate distribution and support transmission voltages," in *PowerTech, 2013 IEEE Grenoble*, pp. 1–6, 2013.
13. A. Maknouninejad, W. Lin, H. G. Harno, Z. Qu, and M. A. Simaan, "Cooperative control for self-organizing microgrids and game strategies for optimal dispatch of distributed renewable generations," *Energy Systems*, vol. 3, pp. 23–60, Mar 2012.
14. P. Aristidou, G. Valverde, and T. Van Cutsem, "Contribution of Distribution Network Control to Voltage Stability : A Case Study," *IEEE Transactions on Smart Grid*, 2015.
15. J. Morin, F. Colas, J.-Y. Dieulot, X. Guillaud, and S. Grenard, "Coordinated predictive control in active distribution networks with HV/MV reactive power constraints," in *2016 IEEE PES Innovative Smart Grid Technologies, Europe (ISGT Europe)*, IEEE, 2016.

16. H. Lefebvre, D. Fragnier, J.-Y. Bousion, P. Mallet, and M. Bulot, "Secondary coordinated voltage control system: feedback of EDF," in *IEEE Power Engineering Society Summer Meeting*, vol. 00, (Seattle), pp. 290–295, 2000.
17. G. Valverde and T. Van Cutsem, "Model predictive control of voltages in active distribution networks," *IEEE Transactions on Smart Grid*, vol. 4, pp. 2152–2161, 2013.
18. J. Lofberg, "YALMIP : a toolbox for modeling and optimization in MATLAB," *IEEE International Conference on Robotics and Automation*, 2004.
19. P. Aristidou, D. Fabozzi, and T. Van Cutsem, "Dynamic Simulation of Large-scale Power Systems Using a Parallel Schur-complement-based Decomposition Method," *IEEE Transactions on Parallel and Distributed Systems*, pp. 1–1, 2013.