



Science Arts & Métiers (SAM)

is an open access repository that collects the work of Arts et Métiers Institute of Technology researchers and makes it freely available over the web where possible.

This is an author-deposited version published in: <https://sam.ensam.eu>
Handle ID: <http://hdl.handle.net/10985/23073>



This document is available under CC BY-NC-ND license

To cite this version :

Tugce TURKBAY, Julien BONGONO, Thecle ALIX, Bertrand LARATTE, Birol ELEVLI - Prior knowledge of the data on the production capacity of boron facilities in Turkey - Cleaner Engineering and Technology - Vol. 10, p.100539 - 2022

Any correspondence concerning this service should be sent to the repository

Administrator : scienceouverte@ensam.eu



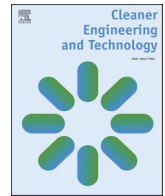

Prior knowledge of the data on the production capacity of boron facilities in Turkey

Tugce Turkbay^a, Julien Bongono^a, Thècle Alix^a, Bertrand Laratte^{a,b,c,*}, Birol Elevli^b

^a Arts et Métiers Institute of Technology, University of Bordeaux, CNRS, Bordeaux INP, INRAE, I2M Bordeaux, F-33400, Talence, France

^b Department of Industrial Engineering, Ondokuz Mayıs University, Samsun, 55139, Turkey

^c French Institute of Anatolian Studies, CNRS USR 3131, Palais de France Nur-i Ziya, 34433, Beyoğlu, Istanbul, Turkey

ARTICLE INFO

Keywords:

Open-pit boron mine
Production capacity
Data quality
Borate minerals

ABSTRACT

The element boron is widely used in many industrial fields (semiconductor industry, glass industry, etc.). In order to assess the environmental impact of industrial products containing boron from cradle to grave, it is necessary to consider the impact of borate minerals on the environment. The literature on this subject is quite poor and the inventory of data on the life cycle of boron mining is very scarce. This article presents a synthesis of a literature review on this topic and provides easy access to important data on boron use and production capacities of Turkish boron facilities. The scope of Turkey has been chosen because the country has the largest deposits of borate ores in the world. The literature review is based on the analysis of sixty-three theses and fourteen reports in the fields of mining engineering, geology and earth sciences, environmental sciences, and chemical engineering. The production capacities from 1985 to 2016 (most recent data) and supporting data for each facility were studied using bibliometrics analysis. The data were then evaluated by calculating a data quality matrix, the coefficient of dispersion, and the standard deviations. We have found that the data compiled is generally of good quality. The values of the production capacities ± 2.3 tons have 95% chance to be the real values of the production capacities of the boron industry in Turkey. The data obtained constitute a basis for enriching models in the field of life cycle assessment (LCA), sustainability, and/or material flow analysis (MFA) applied to borate mineral processing.

1. Introduction

When you plan to take advantage of project data, it is essential to ensure the availability of data, its quantity, possible gaps in data, and especially the available data quality because the inferred models are as good as the data (Kotu and Deshpande, 2019).

Data is of high quality if it is accurate, complete, consistent, reliable, and relevant both when it comes to inflows, outflows, or intermediate flows.

Data quality is characterized by classical statistical methods. But the distribution of data collected for Life Cycle Assessment (LCA) studies is most often characterized according to the quality index determined by the pedigree matrix (Weidema and Wesnaes, 1996) (Frischknecht et al., 2005).

The purpose of this review paper is to summarize and provide easy access to significant literature data on boron production and production capacities from Turkish facilities. Since the majority of the boron

deposits locates in Turkey, most of the publications regarding Turkish boron mining has been published in Turkish. This review paper aims therefore at providing the scientific community with significant data inventory related to Turkish boron mining with the ultimate goal of easing the related research so far hindered by the Turkish-to-English language barrier.

The data at the core of this paper have already been employed in an LCA study carried out by the same authors of this paper, see Turkbay et al. (2022) (Turkbay et al., 2022). Moreover, within the framework of the same research group, Çolak et al. (2022) (Çolak et al., 2022) had access to the yet unpublished data of this paper for tackling the adiabatic depletion connected with the LCA of boron mining. The data at the core of this paper have also been used as an unpublished database for material flow analysis (MFA) to identify the potential exportation to Europe (ulexite, colemanite, and tincal (see Elevli et al. (2022) (Elevli et al., 2022))). Such three publications could have access to the data of this paper in form of private communication as they are grounded under the

* Corresponding author. Arts et Métiers Institute of Technology, University of Bordeaux, CNRS, Bordeaux INP, INRAE, I2M Bordeaux, F-33400, Talence, France.
E-mail address: bertrand.laratte@ensam.eu (B. Laratte).

umbrella of the same “Scientific and Technological Research Council of Turkey” (TUBİTAK) project and they all aim to evaluate boron mining with MFA and LCA. This study has therefore the aim to make available to the scientific community the data used by [4, 5, 6], providing the baseline data to the scientists beyond the TUBİTAK project for future research directions in the field of LCA and/or MFA applied to boron mining.

1.1. Boron mining in Turkey

There are more than 250 types of boron minerals in the world. However, only the four borate minerals—colemanite, kernite, tincal, and ulexite—account for 90% of the borate minerals used by industry (Helvacı, 2003, 2017). Although the term “boron” is commonly referenced, it does not occur in nature in an elemental state. Boron combines with oxygen and other elements to form boric acid, or inorganic salts called borates. Boron compounds, chiefly borates, are commercially important; therefore, boron products are priced and sold based on their boric oxide (B_2O_3) content, varying by ore and compound and by the absence or presence of calcium and sodium.

The important borate deposits in the world are located in Turkey 73 %, Russia 7.7 %, and the U.S.A. 6.1 % (Eroğlu, 2018). The borate minerals extracted in Turkey are tincal, colemanite, and ulexite with their high commercial value (Oner, 2007; Yenmez, 2009). The chemical formula, grade of B_2O_3 , H_2O in the mineral, and the location of the borate minerals in Turkey are given in Table 1 (Aykul, 2008; Harbili Çolak, 2020; Kılınç et al., 2001; Oner, 2007).

Borates are used in various industrial areas as raw materials, side products, and main products. They are used in many different fields such as agriculture, cleaning, glass, porcelain/ceramic materials and coatings, industrial or general use textiles, cleaning chemicals, reflective requirements, metallurgy, fire retardant/preventing materials and additives, nuclear fuel technology, energy, and health (Etimaden, n.d.; Harbili Çolak, 2020). Approximately 86% of the boron in the world is consumed in four main sectors: Glass, ceramics, detergents, and fertilizer. If we look at the distribution of boron products in the world; it is seen that 48% is consumed in the glass sector, 15% in the ceramics sector, 15% in the agricultural sector, 3% in the detergent sector, and the remaining 19% in other sectors (Eti Mining Operations General Directorate, 2019). In parallel with the development in industrial activities and technology, the interest and demand for the borates increase day by day (Yenmez, 2009).

1.2. Boron mineral products

Boron mining leads to a variety of products. Boron products are divided into three main categories according to the origin of the products as (a) natural borates, (b) refined boron products, (c) special boron products. Basic boron compounds obtained by tincal, colemanite, and ulexite are given in Fig. 1. Boric acid is obtained from colemanite and is used to produce boron oxide and disodium octaborate. Two different compounds called borax decahydrate and borax pentahydrate are derived from tincal and they are used to produce anhydrous borax, sodium perborate, and disodium octaborate (Ertan, 2013).

Table 1
Borate minerals in Turkey.

Mineral	Chemical Formula	B_2O_3 %	H_2O %	Reserve %	Location in Turkey
Tincal	$Na_2B_4O_7 \cdot 10H_2O$	36.5	47.2	31.8	Kırka
Ulexite	$NaCaB_5O_9 \cdot 8H_2O$	43.1	35.5	3.7	Emet, Bigadiç
Colemanite	$Ca_2B_6O_{11} \cdot 5H_2O$	50.9	21.9	64.4	Emet, Bigadiç, Kestelek

- Natural Borates:** The borate ores are extracted from the ground and subjected to some physical processes such as washing, crushing, screening, classification, and grinding to increase the grade of B_2O_3 in the mineral (Tok, 2018). These products are Tincal (Borax), Colemanite, and Ulexite.
- Refined boron products:** They are new products obtained from natural borates as a result of dissolution or chemical reaction of the raw or concentrated borate such as filtration, crystallization, drying. These products vary according to the method applied or the chemical substance used. Refined products are used as raw materials in many industries (Kurttepe, 2009; Tok, 2018). These products are sodium perborate (The grade of B_2O_3 : 22 %), borax decahydrate (The grade of B_2O_3 : 36.5 %), borax pentahydrate (The grade of B_2O_3 : 47.8 %), boric acid (The grade of B_2O_3 : 56.5 %), anhydrous borax (The grade of B_2O_3 : 69.3 %), boron oxide, disodium octaborate tetrahydrate (The grade of B_2O_3 : 81.8 %).
- Special Boron Products (Boron Chemicals):** Special boron products are obtained from boric acid or B_2O_3 as raw materials. However, the amount of production and consumption of special boron products are very low compared to refined products (Tok, 2018). These products are zinc borate, ferrobora, special sodium borates, boron hydrides, boron carbide, boron nitride, elemental boron, inorganic borates, trimethyl borate, boron-nitrogen compounds, boron halides, fluoroboric acid, organobor compounds, fluoroborates, and boric acid esters.

1.3. Boron mineral processing

In order to have useable boron, there are three stages as given below:

- The mining:** Mining is the process of extracting boron ore from the ground. Boron minerals are extracted through open-cut operations. Along with the minerals, a significant amount of overburden is also extracted.
- The mineral processing:** The run of mine is crushed and cleaned in order to remove non-boron materials before refining. For borax (tincal) minerals, this step is only crushing. For other minerals, this step includes crushing and removing non-boron minerals in order to have enriched boron minerals, known as concentrate.
- The refining:** At this stage, different refined boron products are produced employing different processes such as dissolving, crystallizing, filtering, drying et al.

The schematic diagram in Fig. 2 depicts the conceptual workflow including multiple processes, inputs, outputs, mining equipment, and after-mining processes such as the production of boric acid, borax pentahydrate, borax decahydrate, and sodium perborate. The colors: white, orange, yellow, green, and violet represent inputs, machines, products, processes, and outputs, respectively. The diagram consists of three main stages: open-pit mining, enrichment, and refinement.

- The mining activity can be described by operations of exploration, drilling, blasting, excavation run-of-mine, loading, and transporting. The layer covering the run-of-mine ore is removed by drilling-blasting methods. After the cover layer on the ore is removed by excavators and loaders, ore extraction is started. The excavation of the ore rock loosened by drilling and blasting is done by hydraulic crawler excavators in between April and September (in Emet), March and December (in Kırka). There is no ore extraction in January and February due to heavy winter conditions. Hydraulic crawler excavators and trucks are used for loading and transportation. The ore extracted from the mine is stockpiled in open stockpiles to be fed to the concentrator facilities when necessary or fed to the concentrator facility, directly (Ataş, 2019; Durmaz, 2018). In addition to these heavy-duty vehicles, greyders, loaders, ripper dozers, and drillers are also used in this stage (Sargin, 2019).

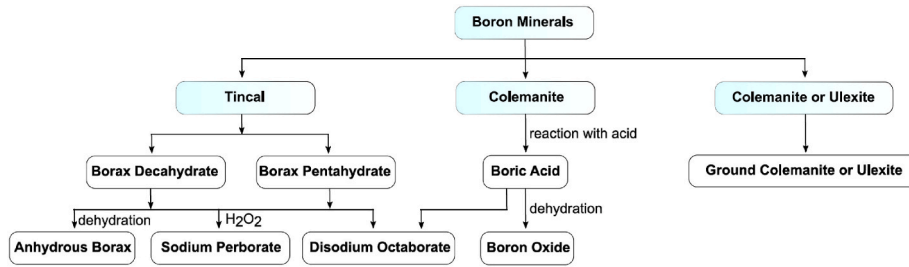

Fig. 1. Basic boron compounds and equivalent products.

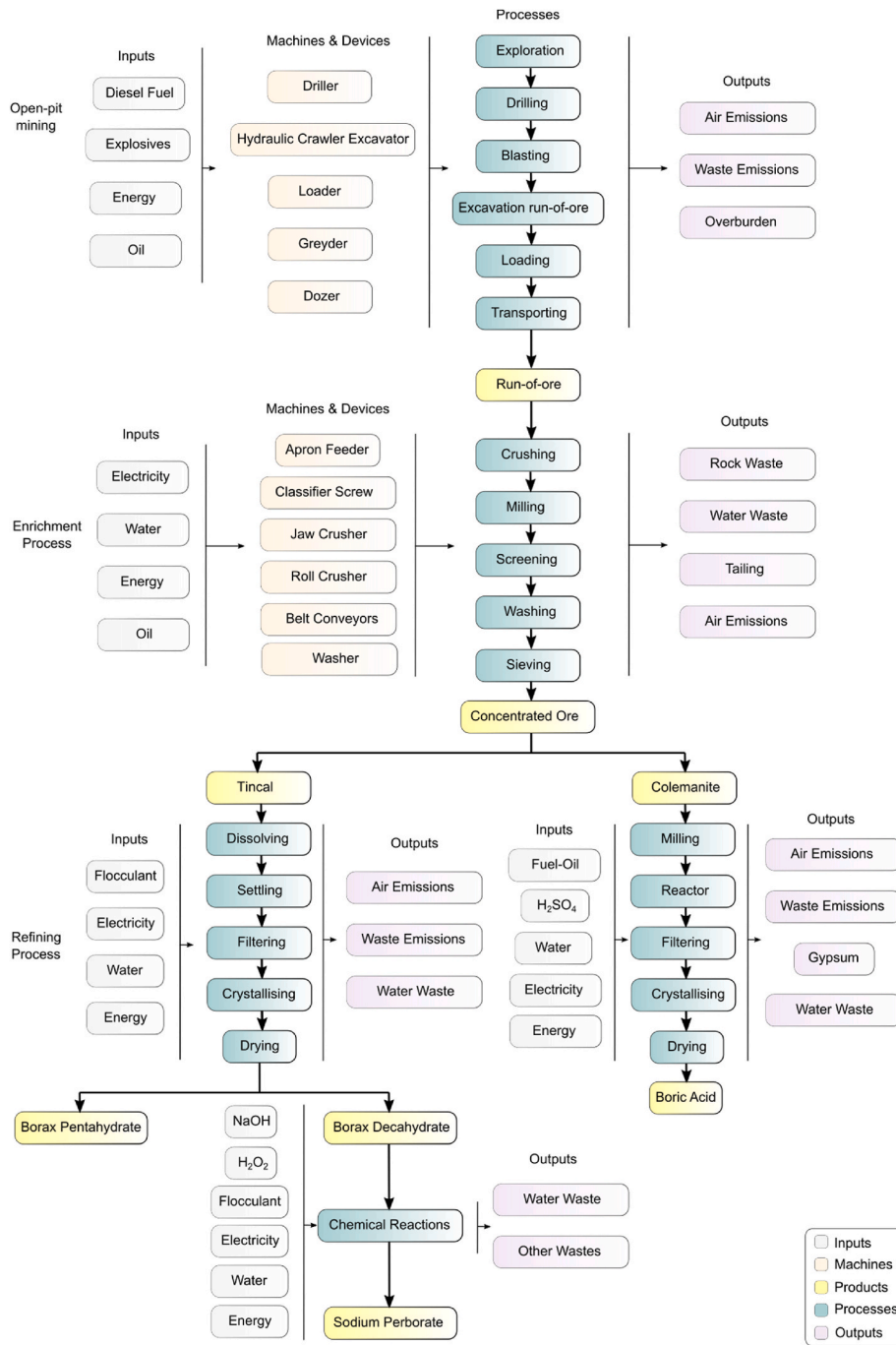

Fig. 2. Schematic representation of boron mining process and derivation of refined products.

- Overall, there are five stages in the enrichment process, beginning with the crushing and culminating in sieving. Although the machines or the size of the final products after crushing and milling are different, the boron concentrator plants in Turkey generally have these five steps: crushing, milling, screening, washing, and sieving. During the enrichment process, the clays that precipitate together with the boron form the waste (Yegül, 2007). The machines used can be generalized as apron feeder, classifier screw, jaw crusher, roll crusher, belt conveyors, and washer (Ak, 2011).
- Although there are many refined boron products, the focus has been given to boric acid, borax pentahydrate, borax decahydrate, and sodium perborate. Derivation of borax pentahydrate and borax decahydrate has the same production processes. The parameters during processes, such as the temperature of the water or the temperature of the crystallizer, determine the final product. Therefore, only one flow chart was used for borax pentahydrate and borax decahydrate here (Türkiye Cumhuriyeti Başbakanlık Devlet Planlama Teşkilatı, 1987).
- The inputs for the summarized diagram are taken from (Türkiye Cumhuriyeti Başbakanlık Devlet Planlama Teşkilatı, 2001; 1987). The outputs have been estimated by using the LCA of general mining publications (Farjana et al., 2019; Ferreira and Leite, 2015).

2. Methodology

There are many LCA studies on mineral mining in the literature. Nevertheless, there is a great lack of literature on LCA on boron mining. In this paper, the production capacities of the boron facilities and the amount of extracted ore will be summarized. We aim at providing practitioners with LCA data that can be used to evaluate the pre-manufacturing phases. We deal with Turkish mines since Turkey has the largest borate deposit worldwide (73 %).

As most of the literature sources are in Turkish and they are not all included neither in the Google Scholar archive nor in the Scopus, Web Science or Science Direct databases, the search engine "Yükseköğretim Kurulu Tez Merkezi" (YÖK Tez Merkezi) has been used to gather the Masters and Ph.D. theses. By law, all the theses published in Turkey must be available on the YÖK Tez Merkezi virtual platform <https://tez.yok.gov.tr>, hence using its search engine we made sure that all the relevant Turkish literature sources are included in the research database.

The following methodology has been employed to conduct our research. At first, the keyword "boron" has been used to filter out the relevant sources by title. 1152 thesis, among Master's and Ph.D.'s, have been found. Even if the one-keyword research might seem too general, it allows having a comprehensive picture of the available Turkish literature such to make sure that no relevant database entry has been overlooked. In the YÖK Tez Merkezi search engine, all the theses are sorted out by the department and a corresponding filter has been applied to the 1152 entries in order to give priority to the mining engineering department. The first 83 theses fell within such a classification and they all have been scanned to find the most relevant sources to our review. Among them, 18 theses have been retained. We stress that research on

boron mining and the respective LCA is intrinsically multidisciplinary, and it requires considering several scientific and technical domains. For instance, mining engineering literature has been used to gather data on equipment, the production capacity of the facilities, and the amount of ore loss, while theses published in the environmental engineering department have been preferentially used to gather information on the environmental impact of boron mining processing and boron waste. Therefore, a second round of research included other departments of publication of the theses, such as chemical engineering, environmental engineering, geological engineering, metallurgical engineering, material science and engineering, civil engineering. All the remaining 1089 titles have been screened and the most relevant theses have been retained. In total, more than 100 theses were considered and 63 of them have been retained for our literature review, see Fig. 3. Such a searching process allowed us to focus on the relevant information for our review and granted a comprehensive database.

Together with the Turkish Masters and Ph.D. theses, 14 technical reports by the Türk Mühendis ve Mimar Odaları Birliği ("Union of chambers of Turkish engineers and architects"), the Eti Maden İşletmeleri Genel Müdürlüğü ("Eti Mining Operations General Directorate"), and the Devlet Planlama Teşkilatı ("State Planning Organization of Turkey") have been included in our source literature. They offer an invaluable source of data about the production capacity of the facilities.

Thereafter, the relevant Masters and Ph.D. theses, articles, and reports are sorted and classified as part of the literature database. The publications are sorted with respect to the following criteria: (i) study place (ii) uses of boron, (iii) mining process, (iv) boron waste, and (v) environmental impact. Generally, 21 theses and 12 reports are considered in deep detail because they report comprehensive descriptions of boron mining and facilities in Turkey.

All the theses investigated were published in Turkey (59 out of 63 is in Turkish and 4 out of 63 is in English) and they dealt with mining engineering, geology and earth science, environmental science, and chemical engineering. The reports were published by Turkey's governmental agency called the Company of Eti Maden which is responsible for operating boron mining and State Planning Organization. Special attention is paid to the amount of extracted run-of ore and production capacities in the facilities. The summary of the publications is given in Table 8, Table 9, and Table 10 following the order of Masters theses, Ph. D. theses, and reports, respectively.

In the next step, the publications were extensively studied to identify the key criteria for conducting a comprehensive literature review. At this stage, all the publications were studied regardless of their evaluation methods, goal, and scope of their research.

Studies conducted within the scope of this review are grouped under five following sections:

- Sec. 1: Information about the boron element, boron minerals, boron products, and uses of boron are given.
- Sec. 2: General information about the study is given and the aim and scope of this review are specified.

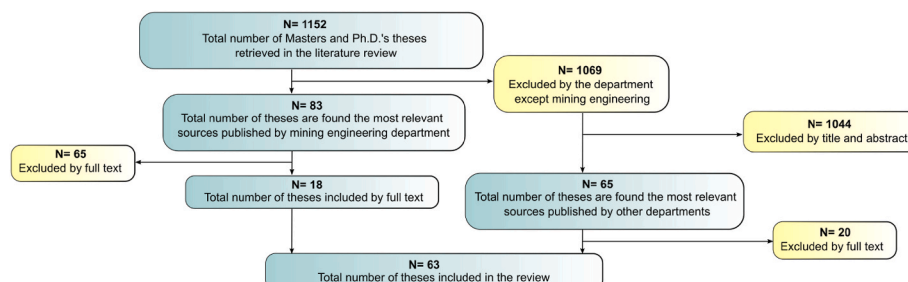

Fig. 3. Systematic literature review process.

- Sec. 3: Information about the five boron facilities in Turkey, their products, and facilities' production capacities are mentioned. The facilities' production capacities are evaluated in detail and the uncertainty is assessed.
- Sec. 4: Data quality matrix, dispersion coefficients, and standard deviation are calculated and the results are discussed.
- Sec. 5: Concluding remarks are provided.

3. Results

3.1. Boron production capacity

The global supply of borates is dominated by just two producers. The first one is state-owned Eti Maden, a monopoly on the world's largest deposits in Turkey. Eti Maden supply almost half of the global market. The second one is the U.S. Borax of America, which operates Boron open cut mine in the U.S.A. Borax in the U.S. (~30%) and Eti Maden of Turkey (>50%) account for approximately 80% of the total global market share (Size, 2019).

Turkey has the world's largest boron reserves as well as including highest B_2O_3 content (Yenmez, 2009). The borate deposits are located in western Anatolia in Turkey and their reserves are 37 % in Balıkesir (Bigadiç), 34 % in Kütahya (Emet), %28 in Eskişehir (Kırka), and 1 % in Bursa (Kestelek) (Oner, 2007). The locations of borate deposits are given in Fig. 4 (Karaman, 2007).

Emet facility is located 100 km from Kütahya city center. There are two different open-pit mine regions within the Emet Boron Operations Directorate, namely Hisarcık (12 km south of Emet) and Espey (4 km north of Emet). Colemanite ore is extracted from both open-pit regions, Espey and Hisarcık (Eroğlu, 2018). There are 1,806,998,090 tons of reserves of colemanite, ulexite, and probertite minerals in the Emet mineralization field (Eti Mining Operations General Directorate, 2020). Most of the products extracted from Espey and Hisarcık are converted into boric acid by grinding in Emet facility. A part of the concentrated products is sent to Bandırma and Acid Plants Operations Directorate to produce boric acid (Eti Mining Operations General Directorate, 2016; Karadağlı, 2019; Tok, 2018). The products are boric acid, concentrated colemanite, and eticol-ceramic.

Bigadiç facility is placed in Osmanca village located in the north-eastern region of Turkey, 12 km away from Bigadiç (Eroğlu, 2018). There are 620,689,753 tons of reserves of colemanite and ulexite minerals in Bigadiç mineralization field (Eti Mining Operations General Directorate, 2020). Concentrated colemanite and ulexite are produced from four open-pit mine zones: Tülü, Acep, Simav, and Kestelek. Extracted borate ores are beneficiated in the concentrator. Some of the concentrated products are sold as the final products and the rest are used to produce ground colemanite and refined boron products (Eti Mining Operations General Directorate, 2016; Karadağlı, 2019). Among the colemanite products, those 26–100 mm in size contain the highest proportion of B_2O_3 and are highly productive colemanite ore. Those

4–25 mm in size contain high levels of B_2O_3 and are the most efficient in obtaining boric acid. 0–3 mm in size are of poor quality. It is used in obtaining boric acid by mixing with other contents (Harbili Çolak, 2020). After the concentrated products are taken to the stocks in Bigadiç, they are transported to Bandırma, 150 km away, by road and by rail from Nusrat train Station (Eti Mining Operations General Directorate, 2016; Hıncalan, 2010; Kılıç, 2010). The products are: concentrated colemanite (3–25, 25–125 mm), granular colemanite (0,2–3 mm), ground colemanite (–75 μ m), concentrated ulexite (3–125 mm), granular ulexite (0.2–3 mm), ground ulexite (–75 μ m), eticol-ceramic, and natural zeolite.

Kırka facility is located in Kırka 74 km away from Eskişehir. It consists of 7 facilities; 5 Borax Pentahydrate and 2 Anhydrous Borax facilities (Eti Mining Operations General Directorate, 2016). The deposit of tincal is 817,924,014 tons in the Kırka mineralization field (Eti Mining Operations General Directorate, 2020). It is the largest tincal deposit in the World. Tincal ores are processed by the open-pit mining method. After they are converted to concentrated tincal, most of them are used to produce borax pentahydrate (Eti Mining Operations General Directorate, 2016; Karadağlı, 2019). The products are Etibor-48 (borax pentahydrate) ($Na_2B_4O_7 \cdot 5H_2O$), Etibor-68 (anhydrous borax) ($Na_2B_4O_7$), calcined tincal (compressed), and borax decahydrate.

Kestelek facility is located in Kestelek which is 83 km away from Bandırma (Karadağlı, 2019). The deposit of colemanite is 5,254,923 tons in the Kestelek mineralization field (Eti Mining Operations General Directorate, 2020). Only colemanite is extracted in this open-pit mine. The colemanite ores are beneficiated in the concentrator and processed to produce concentrated colemanite (Karadağlı, 2019).

Bandırma Boron and Acid facility was established on 667,350 m² area where 4 km far away from the Balıkesir city center. The borate mineral is not extracted in Bandırma. The facility was only established to convert concentrated borate minerals into refined boron products. There is also a sulfuric acid plant within the facility to provide sulfuric acid required in refined boron production processes (Eti Mining Operations General Directorate, 2016; Yenmez, 2009). In Turkey, boric acid is obtained from colemanite. The vast majority of boric acid is produced in Bandırma and a portion of boric acid is produced in Emet. Bandırma was established before finding the tincal deposit in Kırka. It has been continuing to obtain borax and boric acid from colemanite since 1967 (Eti Mining Operations General Directorate, 2016; Harbili Çolak, 2020; Karadağlı, 2019). The products are borax decahydrate, Etibor 48 (borax pentahydrate), boric acid, boron oxide (glassy, amorphous), etidot 67 (agricultural boron), etibor 68 (anhydrous borax), sodium perborate, sulfuric acid, and Eti-ZnBor (zinc borate).

Production capacity indicates the maximum probable output of a facility over a set period of time. In the literature, the most up-to-date data of the production capacity of concentrated boron and refined products at these five operation directorates was published in 2016. The number of data in the literature related to the run-of-borate ore is limited and there are few data about it. Table 2 includes all the different data related to production capacity and the number of processes extracted ore in the five boron facilities in Turkey; Emet, Bigadiç, Kırka, Kestelek, and Bandırma. There is no refinement facility in Kestelek. Bandırma only processes concentrated ore transported by other facilities. The years in the table are based on the publication year of the relevant citation in the reference source in the literature. The data published by the Company of Eti Maden is the most reliable source and the relevant quotations are highlighted with the "*" symbol.

3.2. Important findings

The data in Table 2 is used to produce graphs including extracted ore and production capacity over years for all the facilities in Fig. 5.

The facility of Emet (a);

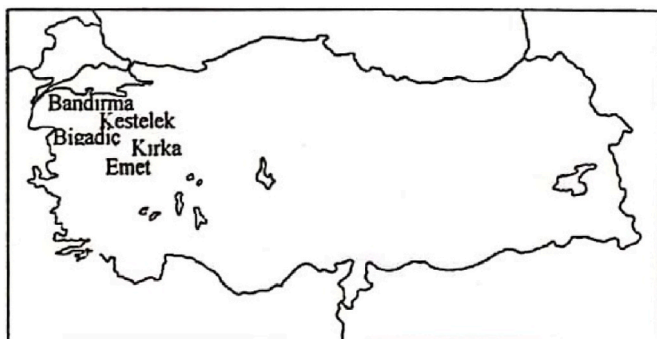

Fig. 4. Turkey's map with borate deposits distribution.

Table 2
Production capacity of boron facilities (1000 ton/year).

Facility	Extracted run-of-ore	Concentrated Products	Refined Products
Emet	Run-of-Colemanite	Colemanite	Boric Acid
	Espey 300 (1994) (Yaşar, 1994) cited in (Handırı, 2010)	Espey 120 (1994) (Yaşar, 1994) cited in (Handırı, 2010), (2001) (Türkiye Cumhuriyeti Başbakanlık Devlet Planlama Teşkilatı, 2001)*	100 (2006) (Eti Mining Operations General Directorate, 2006)*
	Espey 300 (2001) (Türkiye Cumhuriyeti Başbakanlık Devlet Planlama Teşkilatı, 2001)*	Hisarcık 450 (1994) (Yaşar, 1994) cited in (Handırı, 2010), (2001) (Türkiye Cumhuriyeti Başbakanlık Devlet Planlama Teşkilatı, 2001)*	120 (2008,2009,2010) (Eti Mining Operations General Directorate, 2008, 2009, 2010)*
	Hisarcık 900 (1994) (Yaşar, 1994) cited in (Handırı, 2010)	500 (1985) (Taneri, 1985) cited in (Koçak, 2010)	240 (2012) (Eti Mining Operations General Directorate, 2012)*
	900 (1987) (Türkiye Cumhuriyeti Başbakanlık Devlet Planlama Teşkilatı, 1987)*	450 (1994) (Yaşar, 1994)	290 (2014) (Boren, n.d.) cited in (Sarhan, 2019), (Türk Mühendis ve Mimar Odaları Birliği, 2016)
	900 (1994) (Yaşar, 1994)	400 (2002) (Güyağüler, 2001) cited in (Oner, 2007)	100 (2015) (The Statistics Portal, n.d.) cited in (Karadağlı, 2019)
	900 (2005) (Eti Mining Operations General Directorate, 2005) cited in (Karaman, 2007)	900 (2006) (Eti Mining Operations General Directorate, 2006)*	290 (2016) (Eti Mining Operations General Directorate, 2016) cited in (Eroğlu, 2018)
	1000 (2006) (Eti Mining Operations General Directorate, 2006)*	900 (2015) (The Statistics Portal, n.d.) cited in (Karadağlı, 2019)	
		900 (2016) (Eti Mining Operations General Directorate, 2016) cited in (Eroğlu, 2018)	
	Bigadiç	Run-of-Colemanite and Ulexite	Colemanite and Ulexite
150 (1987) (Türkiye Cumhuriyeti Başbakanlık Devlet Planlama Teşkilatı, 1987)*		150 (1980) (Gökçek, 2010)	90 (1998, colemanite and ulexite) (Gökçek, 2010)
600 (2001) (Türkiye Cumhuriyeti Başbakanlık Devlet Planlama Teşkilatı, 2001)*		400 (1985) (Taneri, 1985) cited in (Koçak, 2010)	30 (2001) (Türkiye Cumhuriyeti Başbakanlık Devlet Planlama Teşkilatı, 2001)*, (Türk Mühendis ve Mimar Odaları Birliği, 2003)
800 (2006) (Eti Mining Operations		650 (1990) (Gökçek, 2010)	60 (2002) (Güyağüler, 2001) cited in (Oner, 2007)

Table 2 (continued)

Facility	Extracted run-of-ore	Concentrated Products	Refined Products
	General Directorate, 2006)*		
	600 (2010) (Kılıç, 2010)	400 (1994) (Yaşar, 1994)	90 (2006) (Eti Mining Operations General Directorate, 2006)*
		400 (2001) (Türkiye Cumhuriyeti Başbakanlık Devlet Planlama Teşkilatı, 2001)*	300 (2008,2009,2010,2012) (Eti Mining Operations General Directorate, 2012, 2010, 2009, 2008)*
		560 (2001) (Türk Mühendis ve Mimar Odaları Birliği, 2003)	700 (2013) (Eti Mining Operations General Directorate, 2013)*
		400 (2002) (Güyağüler, 2001) cited in (Oner, 2007)	700 (2014) (Boren, n.d.) cited in (Sarhan, 2019), (Türk Mühendis ve Mimar Odaları Birliği, 2016)
		650 (2005) (Eti Mining Operations General Directorate, 2005) cited in (Karaman, 2007)	90 (2015) (The Statistics Portal, n.d.) cited in (Karadağlı, 2019)
		650 (2006) (Eti Mining Operations General Directorate, 2006)*	
		975 (2007) (Gökçek, 2010)	
		400 (2010) (Kılıç, 2010)	
		1045 (2012) (Eti Mining Operations General Directorate, 2012)* cited in (Eroğlu, 2018)	
		650 (2015) (The Statistics Portal, n.d.) cited in (Karadağlı, 2019)	
Kırka	Run-of-Tincal	Tincal	Borax Pentahydrate
	600 (1987) (Türkiye Cumhuriyeti Başbakanlık Devlet Planlama Teşkilatı, 1987)*	800 (1985) (Taneri, 1985) cited in (Koçak, 2010)	160 (1994) (Yaşar, 1994)
	600 (1994) (Yaşar, 1994)	400 (1994) (Yaşar, 1994) cited in (Handırı, 2010)	450 (2001) (Türk Mühendis ve Mimar Odaları Birliği, 2003)
	1150 (1994) (Handırı, 2010)	800 (2001) (Türk Mühendis ve Mimar Odaları Birliği, 2003), (Türkiye Cumhuriyeti Başbakanlık Devlet Planlama Teşkilatı, 2001)*	480 (2006) (Eti Mining Operations General Directorate, 2006)*
	1150 (2001) (Türkiye Cumhuriyeti Başbakanlık	800 (2002) (Güyağüler, 2001) cited in (Oner, 2007)	600 (2008,2009,2010) (Eti Mining Operations General Directorate, 2008, 2009, 2010)*

(continued on next page)

Table 2 (continued)

Facility	Extracted run-of-ore	Concentrated Products	Refined Products
	Devlet Planlama Teşkilatı, 2001)* 1150 (2003) (Kılıç, 2010)	800 (2005) (Eti Mining Operations General Directorate, 2005) cited in (Karaman, 2007)	160 (2010) (Kılıç, 2010)
	2000 (2006) (Eti Mining Operations General Directorate, 2006)*	800 (2009) (Şensoy et al., n.d.)	840 (2012) (Eti Mining Operations General Directorate, 2012)*
		800 (2015) (The Statistics Portal, n.d.) cited in (Karadağlı, 2019)	840 (2014) (Boren, n.d.) cited in (Sarhan, 2019), (Türk Mühendis ve Mimar Odaları Birliği, 2016) 480 (2015) (The Statistics Portal, n.d.) cited in (Karadağlı, 2019) 840 (2016) (Eti Mining Operations General Directorate, 2016) cited in (Eroğlu, 2018) Borax Decahydrate 17 (1994) (Yaşar, 1994) 17 (2001) (Türk Mühendis ve Mimar Odaları Birliği, 2003) 80 (2010,2012) (Eti Mining Operations General Directorate, 2010, 2012)* 80 (2014) (Boren, n.d.) cited in (Sarhan, 2019), (Türk Mühendis ve Mimar Odaları Birliği, 2016) 80 (2016) (Eti Mining Operations General Directorate, 2016) cited in (Eroğlu, 2018) Anhydrous Borax 60 (1985) (Taneri, 1985) cited in (Koçak, 2010) 60 (1994) (Yaşar, 1994) 60 (2001) (Türk Mühendis ve Mimar Odaları Birliği, 2003) 10 (2014) (Türk Mühendis ve Mimar Odaları Birliği, 2016)
Kestelek	Run-of-Colemanite	Colemanite	No production
	200 (2001) (Türkiye Cumhuriyeti Başbakanlık Devlet Planlama Teşkilatı, 2001)* 200 (2006) (Eti Mining Operations General Directorate, 2006)*	100 (1985) (Taneri, 1985) cited in (Koçak, 2010) 90 (2001) (Türkiye Cumhuriyeti Başbakanlık Devlet Planlama Teşkilatı, 2001)* 100 (2001) (Türk Mühendis ve Mimar Odaları Birliği, 2003) 100 (2002) (Güyagüler, 2001)	

Table 2 (continued)

Facility	Extracted run-of-ore	Concentrated Products	Refined Products
		cited in (Oner, 2007) 100 (2005) (Eti Mining Operations General Directorate, 2005) cited in (Karaman, 2007) 100 (2006) (Eti Mining Operations General Directorate, 2006)* 100 (2015) (The Statistics Portal, n.d.) cited in (Karadağlı, 2019)	
Bandırma	No extraction	No production	Borax Decahydrate and Borax Pentahydrate
			55 (1985) (Taneri, 1985) cited in (Koçak, 2010) 55 (1994, decahydrate) (Yaşar, 1994) 55 (2001) (Türk Mühendis ve Mimar Odaları Birliği, 2003) 55 (2005) (Eti Mining Operations General Directorate, 2005) cited in (Karaman, 2007) 55 (2006) (Eti Mining Operations General Directorate, 2006)* 115 (2008,2009,2010,2012 decahydrate) (Eti Mining Operations General Directorate, 2008, 2009, 2010, 2012)* 23 (2010, pentahydrate) (Kılıç, 2010) 65 (2010, decahydrate) (Kılıç, 2010) 15 (2014, decahydrate) (Boren, n.d.) cited in (Sarhan, 2019) 55 (2015) (The Statistics Portal, n.d.) cited in (Karadağlı, 2019) Boron Oxide 1 (2005) (Eti Mining Operations General Directorate, 2005) cited in (Karaman, 2007) 1 (2006) (Eti Mining Operations General Directorate, 2006)* 2 (2008,2009,2010,2012) (Eti Mining Operations General Directorate, 2008, 2009, 2010, 2012)* 2 (2014) (Boren, n.d.) cited in (Sarhan, 2019), (Türk Mühendis ve Mimar Odaları Birliği, 2016) 1 (2015) (The Statistics Portal, n.d.) cited in (Karadağlı, 2019) Sodium Perborate 20 (1985) (Taneri, 1985) cited in (Koçak, 2010) 20 (1994) (Yaşar, 1994)

(continued on next page)

Table 2 (continued)

Facility	Extracted run-of-ore	Concentrated Products	Refined Products
			20 (2001) (Türk Mühendis ve Mimar Odaları Birliği, 2003)
			20 (2005) (Eti Mining Operations General Directorate, 2005) cited in (Karaman, 2007)
			20 (2006) (Eti Mining Operations General Directorate, 2006)*
			35 (2008,2009,2010,2012) (Eti Mining Operations General Directorate, 2008, 2009, 2010, 2012)*
			35 (2014) (Boren, n.d.) cited in (Sarhan, 2019), (Türk Mühendis ve Mimar Odaları Birliği, 2016)
			20 (2015) (The Statistics Portal, n.d.) cited in (Karadağlı, 2019)
			Boric Acid
			85 (1985) (Taneri, 1985) cited in (Koçak, 2010)
			25 (1994) (Yaşar, 1994)
			85 (2001) (Türk Mühendis ve Mimar Odaları Birliği, 2003)
			85 (2005) (Eti Mining Operations General Directorate, 2005) cited in (Karaman, 2007)
			85 (2006) (Eti Mining Operations General Directorate, 2006)*
			95 (2008,2009,2010,2012) (Eti Mining Operations General Directorate, 2008, 2009, 2010, 2012) *
			95 (2014) (Boren, n.d.) cited in (Sarhan, 2019), (Türk Mühendis ve Mimar Odaları Birliği, 2016)

- Three literature sources report that the amount of run-of-ore fed to the mineral processing plant is 900,000 ton/year. However, 900,000 ton/year in Hisarcık and 300,000 ton/year in Espey are given by other sources. Considering Emet consists of two plants (Hisarcık and Espey), the total amount of Hisarcık and Espey in 1994 (1,200,000 ton/year) is not the same as with 900,000 ton/year of Emet in 1994 given by other literature sources.
- The capacity of the mineral processing plant for concentrated colemanite production is given in the range of 400,000–570,000 ton/year between the years 1994–2002. After that, it increased to 900,000 ton/year in 2006.
- Three literature sources report that the boric acid production capacity is 290,000 ton/year between the years 2014–2016. On the other hand, 100,000 ton/year is given in 2015. In general, boric acid production capacity has increased over the years.

The facility of Bigadiç (b);

- The amount of ore fed to the mineral processing plant has four different data. The lowest data is 150,000 ton/year in 1987 and this data has quadrupled in 2001.
- The concentrated colemanite and ulexite are given as total. Considering the lowest data (150,000 ton/year) is the oldest data (1980), it can be eliminated. The production capacity ranges in 400,000–650,000 ton/year between the years 1985–2006 and it

increases from 650,000 ton/year in 2006 to 975,000 ton/year in 2007. However, another data which is the exception data of this increasing trend is that 400,000 ton/year in 2010 which is 575,000 ton/year lower than the one in 2007. The highest data is 1,045,000 ton/year in 2012.

- There are three main data for the grained colemanite production capacity. While the first data changing within the range of 30,000–90,000 ton/year, the second main data is 300,000 ton/year with a large change in compared to first data range and this one is around 700,000 ton/year.

The facility of Kırka (c);

- It is reported that the amount of run-of-ore processed in the mineral processing plant is 600,000 ton/year in 1987 and 1994. However, another data is 1,150,000 ton/year in 1994. Two literature sources in 2001 and 2003 agree on this estimate. Although the amount of run-of-ore increases to 2,000,000 ton/year in 2006, the production capacity of concentrated products stays constant.
- The capacity of the mineral processing plant in Kırka has not changed and it is 800,000 ton/year supported by seven literature sources.
- The borax pentahydrate follows an increasing trend in production capacity over the years. The data disrupting the trend is 160,000 ton/year in 2010 and 480,000 ton/year in 2015.
- The borax decahydrate follows an increasing trend in production capacity over the years like borax pentahydrate.
- Three literature sources report that the anhydrous borax production capacity is 60,000 ton/year between the years 1985–2001. On the other hand, the newest data is in 2015 and it is 10,000 ton/year.

The facility of Kestelek (d);

- There are only two literature sources available for the run-of ore and it is 200,000 ton/year in 2001 and 2006.
- The concentrated colemanite shows robust data which is 100,000 ton/year supported by six literature sources.

The facility of Bandırma (e);

- The data for borax pentahydrate and borax decahydrate are given separately and in total. It is reported that the production capacity of borax decahydrate is 15,000, 55,000, 65,000 and 115,000 ton/year. There is no link between the data and the years. The total data for borax pentahydrate and borax decahydrate are robust and it is 55,000 ton/year, but this data does not show consistency with the production capacity of borax decahydrate. For instance, 65,000 ton/year in 2010 for only borax decahydrate is more than 55,000 ton/year in 2015 which is the total production capacity of borax decahydrate and borax pentahydrate.
- The production capacity of boron oxide is 1,000 ton/year in 2005, 2006 and 2015 and 2,000 ton/year reported by five references.
- Five literature sources report that the sodium perborate production capacity is 20,000 ton/year between the years 1985–2015. On the other hand, it is reported as 35,000 ton/year by six literature resources.
- Four literature sources report that the boric acid production capacity is 85,000 ton/year between the years 1985–2006. Five updated literature sources report 95,000 ton/year.

When the results are generalized, the data obtained from (The Statistics Portal, n.d.) cited in (Karadağlı, 2019) in 2015 is inconsistent with other data close to the relevant year.

3.2.1. The input data to the boron facilities

Among the literatures sources which are shown in Appendix

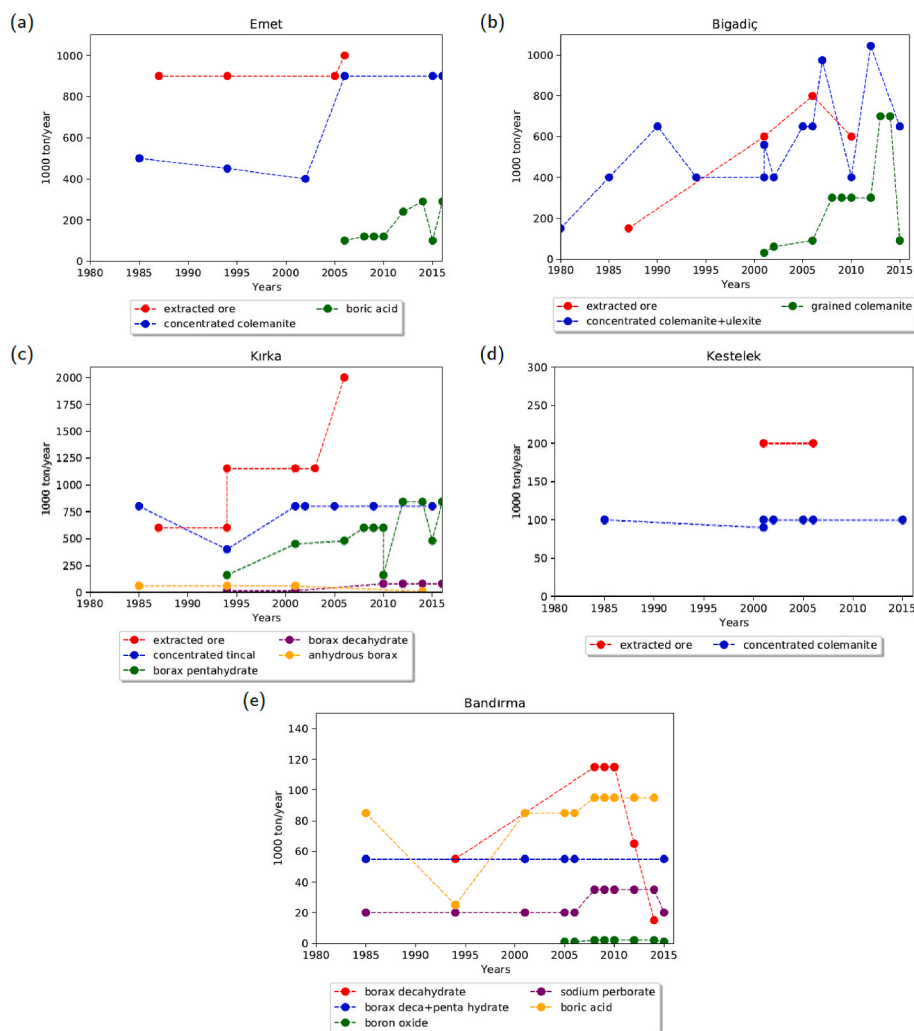

Fig. 5. The production capacities of the facilities over the years.

(Tables 8–10), the most accessible and reliable data taken from the governmental source regarding open-pit-boron mine, concentrator plant and refining facilities are given in Tables 3–5. The used dynamite, Technical Ammonium Nitrate (T.A.N.), electric capsule, diesel fuel, oil, electricity, and energy for five boron open-pit-mine facilities are given in Table 3. The used gasoline, diesel, oil, electricity, and energy for enriching the boron minerals in five concentrator plants are given in Table 4. The input data of the refining process for boric acid, borax pentahydrate, borax decahydrate, and sodium perborate are given in Table 5.

3.3. Boron production levels worldwide

Table 6 includes the production level of the borate minerals in Turkey and in other countries between 2012 and 2016 (2016). Table 2

Table 3

Inputs for open-pit-boron mine (Türkiye Cumhuriyeti Başbakanlık Devlet Planlama Teşkilatı, 2001).

Facility	Dynamite (kg/ton)	T.A.N. (kg/ton)	Electric Capsule (piece/ton)	Diesel Fuel (l/ton)	Oil (kg/ton)	Electricity (kWh/ton)	Energy (kWh/ton)
Emet Hisarcık	0.002	0.033	0.001	0.336	0.015	–	0.373
Emet Espesay	0.002	0.057	0.003	0.58	0.033	–	0.724
Bigadiç	0.0023	0.0461	0.0043	0.4141	0.0239	–	1.0081
Kırka	0.076	0.003	0.002	0.508 (kg/ton)	0.019	0.296	–
Kestelek	0.001	0.015	0.002	2.651	0.099	–	26.438

Table 4

Inputs for concentrator plant (Türkiye Cumhuriyeti Başbakanlık Devlet Planlama Teşkilatı, 2001).

Facility	Gasoline (kg/ton)	Diesel (l/ton)	Oil (kg/ton)	Electricity (kWh/ton)	Energy (kWh/ton)
Emet	–	0.627	0.061	–	5.994
Hisarcık	–	0.827	0.061	–	9.045
Emet Espesay	–	0	0.003	7.375	–
Bigadiç	–	0	0.003	7.375	–
Kırka	0.0036	0.094 (kg/ton)	0.0277	11.1995	–
Kestelek	–	–	–	–	–

Table 5
Inputs for 1 ton refined product (Türkiye Cumhuriyeti Başbakanlık Devlet Planlama Teşkilatı, 1987).

Refined Product	Input	Unit	Amount
Boric Acid	Colemanite	ton	1.5
	Sulfuric Acid	ton	0.9
	Electricity	kWh	130
	Steam	ton	1
	Water	ton	25
	Compressed Air	m3	15
	Fuel-Oil	km	48
Borax Pentahydrate	Tincal	ton	2.3
	Flocculant	kg	0.3
	Electricity	kWh	130
	Steam	ton	5
	Water	ton	45
Borax Decahydrate	Tincal	ton	1.7
	Flocculant	kg	0.3
	Electricity	kWh	125
	Steam	ton	2
	Water	ton	14
Sodium Perborate	Concentrated Tincal	ton	1.1
	Flocculant	kg	0.3
	NaOH (48 %)	ton	0.3
	H ₂ O ₂ (70%)	ton	0.3
	Other materials	kg	5
	Electricity	kWh	110
	Water	ton	6
	Steam	ton	1

Table 6
Production level of borate minerals worldwide (1000 ton/year).

Country or locality	2012	2013	2014	2015	2016
Argentina, boron minerals, crude	479	426	450	450	450
Bolivia, ulexite, natural	128	150	152	150	150
Chile, ulexite, natural	444	581	497	518	520
China	160	160	160	160	160
Germany, compounds	149	143	139	–	–
Iran, borax	1	1	1	1	1
Kazakhstan	300	348	507	500	500
Peru, borates, crude	104	224	240	660	660
Russia	250	76	81	80	80
Turkey:					
Concentrate	2.130	2.130	2.400	2.200	2.200
Run-of-mine	4.220	4.070	7.310	7.300	7.300

^eEstimated. ^rRevised. – Zero.

indicates the maximum possible output of the boron facilities while Table 6 shows the amount of the produced borate minerals. It is seen that the production level of borate mineral in Turkey is quite high compared to other countries. While run-of-ore level increased in 2014, 2015 and 2016, the production level of concentrated borate mineral

remained at the same values in Turkey. These ores may have been exported because the over-extracted ores had no effect on concentrated boron production.

All this information and the metadata in Table 8, Table 9, and Table 10 allow us to characterize the data collected, their quality scores via the pedigree matrix, and the corresponding distributions. The procedure described and well documented in the literature is available in (Leroy, 2009; Weidema et al., 2013). To implement this procedure, Fig. 2 is simplified and represented below Fig. 6, with P, the data of each production activity corresponds to the production capacity. P0 is the reserves of boron mines in Turkey.

This simplified diagram makes it possible to identify the data on which the uncertainty is evaluated, and later, how the errors propagate and affect the results of boron mining LCA studies. Nevertheless, the uncertainty due to the variation and to the stochastic errors cannot be evaluated since its evaluation on each data collected requires that the available information be sufficient. But too often, there is a single source of information that provides one or two values without any information on the uncertainty of these values. The uncertainty assessed here is due to the use of estimates, lacking verification, incompleteness in the sample, extrapolation from temporally, spatially and/or technologically incoherence as defined by (Weidema et al., 2013). This type of uncertainty is assessed by assigning a score of 1 to 0 to each data quality criterion: 1 indicating optimal representativeness. 0, on the other hand, reflects the lowest representativeness. The quality criteria also called indicators are described for each score in the pedigree matrix. The scores obtained can be converted into a dispersion coefficient which will be used to calculate the standard deviation at 95% level of confidence (SD95). The SD95 is calculated according to equation 1.

$$S95 = \sqrt{U1^2 + U2^2 + U3^2 + U4^2 + U5^2}$$

Where U1, U2, U3, U4, U5 represent the dispersion coefficients of the evaluation criteria: reliability, completeness, temporal correlation, geographical correlation, and technological correlation.

The versions used of the pedigree matrix and of the table for converting scores into dispersion coefficients are those presented in the thesis of Leroy, (2009) (Leroy, 2009). Data quality matrix, dispersion coefficients, and standard deviation at 95% obtained are summarized in Table 7.

4. Discussion

In Table 2, the production capacities per year are summarized and in Fig. 4, these data are grafted. Several estimates from different literature sources are included in the table in order to highlight contradictory data reported in the literature. Data scatter is an unfortunate characteristic of the boron-mining-related literature we took into account. In fact, different estimates are reported even in the theses published the same year because not all of them consider the most up-to-date literature

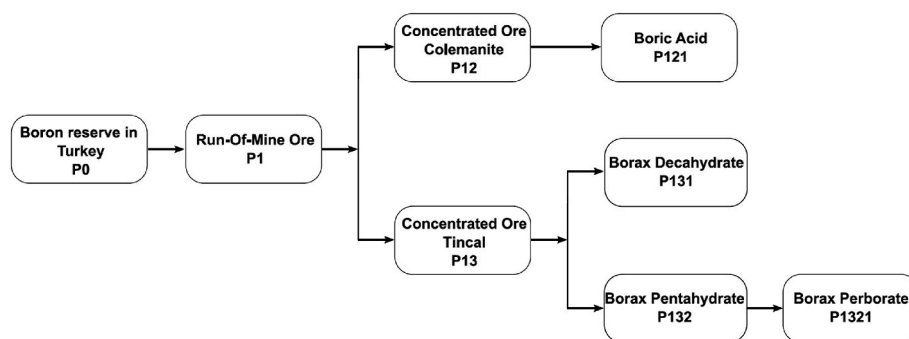

Fig. 6. Simplified diagram of boron mining and product refining processes (Not all of the concentrated colemanite and concentrated tincal transformed to other products. They are also used as concentrated.).

Table 7
Data quality matrix, dispersion coefficients, and standard deviation at 95% level of confidence.

Production Capacity	Data quality matrix (Scores of the pedigree matrix (Weidema, 1998; Weidema and Wesnaes, 1996))	Dispersion coefficients according to the different scores of the pedigree matrix [Ecolnvent 07]	Standard deviation at 95% (SD95)
P0	M0: [1;1;1;1;1]	UP0: [1.00;1.00;1.01;1.02;1.03]	2.26
P1	M1: [1;1;0.75;1;1]	UP1: [1.00;1.00;1.03;1.02;1.03]	2.27
P12	M12: [1;1;1;1;1]	UP12: [1.00;1.00;1.01;1.02;1.03]	2.26
P13	M13: [1;1;0.75;1;1]	UP13: [1.00;1.00;1.03;1.02;1.03]	2.27
P121	M121: [1;1;1;1;1]	UP121: [1.00;1.00;1.01;1.02;1.03]	2.26
P131	M131: [1;1;1;1;1]	UP131: [1.00;1.00;1.01;1.02;1.03]	2.26
P132	M132: [1;1;1;1;1]	UP132: [1.00;1.00;1.01;1.02;1.03]	2.26
P1321	M1321: [1;1;0.75;1;1]	UP1321: [1.00;1.00;1.03;1.02;1.03]	2.27

The values of the data quality matrices are all equal to or close to 1, indicating that the data collected is generally of good quality. In addition, the standard deviation at 95% level of confidence, low, is approximately 2.3 tons. This means that the data collected, the values of the production capacity in this case, plus or minus 2.3 tons, have a 95% chance of being the values of the actual production capacities of the boron facilities in Turkey.

sources. We, therefore, recommend referring to the original technical reports of the boron mining governmental agency. Among them, the most significant database has been published by Eti Maden İşletmeleri Genel Müdürlüğü ("Eti Mining Operations General Directorate") and Devlet Planlama Teşkilatı ("State Planning Organization of Turkey").

Firms tend to increase their production capacity according to demand. However, from 2014 to 2016 (Table 6), run-of-ore production levels almost doubled compared to production capacities before 2010. This suggests that run-of-ore production capacities in Turkey have steadily increased and that they have at least doubled over the past ten years. This important result, not directly accessible from Table 2 despite the diversity of the literature used to design it, corroborates that boron has recently been identified by the EU as a critical material.

If this first interpretation seems plausible, it cannot be ruled out that the evolution of the demand for boron products has influenced production capacities over time. For example, regulations N° 1272/2008 (EC) and N° 528/2012 (EU) which classify boric acid as carcinogenic and toxic for reproduction (category 1B) are likely to slow down the demand for this product for applications in the cosmetics industry (lotions and creams). The drop in demand due to regulation is a probable cause of the drop in boric acid production in 2015 at the Emet site, see Table 2. The variations in production capacities also depend on the level of competitiveness of the technologies used on the production sites, but these data are difficult to access.

Other sources of error are the fact of not always having access to all the data on the production activities of boron products from a single source of information, see Table 2. Information providers can provide reliable data for the activities of their own, but not the underlying activities that are beyond their control. If for the latter, the data are

A. Funding

This paper has been produced benefiting from the 2232 International Fellowship for Outstanding Researchers Program of TÜBİTAK (Project No: 118C219). However, the entire responsibility of the paper belongs to the owner of the paper. The financial support received from TÜBİTAK does not mean that the content of the publication is approved in a scientific sense by TÜBİTAK.

unavailable (unknown or not accessible), they will be generated either by modeling or by calculation, or even by estimation, which makes the data generated less reliable than the source data (Leroy, 2009).

Even if some of the data collected are estimated data, the strength of this study is to be able to collect data on a unit process level, and this for the quasi-whole of the collection of unit processes of the boron product system, giving thus a good appreciation of the existing data and the uncertainties to be considered. However, this study was unable to access errors due to variations in measurements and errors due to models used to estimate the data collected, which to some extent limits the scope of this study.

5. Conclusion

In the literature, although there are many life cycle inventory datasets for the mining process, there is no a collective dataset for boron mining. This study aimed to give information about boron mining to the readers, to classify the studies related to boron mining in the literature and to create a dataset. In this review, the focus has been given to boron mining in Turkey since Turkey has the largest boron deposits in the world and is the largest supplier of borate minerals. Sixty-three theses and fourteen reports were investigated in detail and classified into five categories which are study place, uses of boron, mining process, and environmental impact. In order to represent the main workflow of the mining process, Fig. 2 were drafted out by summarizing theses, reports, and some other publications. The main output of this literature review is to provide the readers with reference baseline values of production capacities of boron facilities in Turkey, which is reported in Table 2.

We stress that this research domain is largely unexplored and, to the best of the author's knowledge, only a few and out-of-date publications are available for boron mining LCA. We, therefore, expect that such a structured content will be of help for future research works in order to improve the knowledge of boron. Many data are missing in different fields of research from process optimization to environmental impacts. With our work of review, we are able to propose a better view of this resource in Turkey even if some data are based on some assumptions. Our further study is now to evaluate the potential environmental impacts of conducting an LCA of the process. More than 20 years ago, such a study has been yet conducted by Azapagic (1999) but no updates have been provided till today (Azapagic, 1999). We believe that this study will be very useful for researchers who want to perform an LCA study of the boron mining industry and the theses investigated in this review will be the source literature for collecting data to create inventory for the LCA study. In addition, Turkey is the major supplier of natural and refined borates to the EU (European Commission, 2014). As boron has been identified as critical material by the EU, it seems relevant to improve this research with a particular focus on the abiotic depletion indicator in LCA. One of the main challenges will be also to determine an appropriate functional unit for the mining sector since there is no consensus on the definition of the boundaries of the system (Bongono et al., 2020).

Declaration of competing interest

The authors declare that they have no known competing financial interests or personal relationships that could have appeared to influence the work reported in this paper.

B. Appendix

The summary of the publications is given in [Tables 8–10](#) following the order of Masters theses, Ph.D. theses, and reports, respectively.

Table 8
Masters theses related to boron mining.

Author	Title	Year	University	The aim of the study	Study place	Uses of boron	Mining process	Boron waste	Envir. impact	Comments	Ref.
Ayşe Zeki	Etibank boraks fabrikasi atıklarından, ham boraks, saf boraks, borik asit, perborat üretim şartlarının araştırılması	1985	Istanbul University	A study has been carried out on the reprocessing of borax, which is 20–35 % in the solution of Eti Maden sludge wastes.		✓	✓		✓	Since the publication is quite old, it has not been used.	Zeki, (1985)
Emre Yaşar	Bor minerallerinin elektrostatik ve elektrokinetik özellikleri	1994	Istanbul Technical University	Electrokinetic and electrostatic properties, which constitute the basic principles of flotation and electrostatic separation among the methods used for the enrichment of boron minerals, have been investigated.		✓	✓			The thesis has been used although it is old. Because other theses showed this thesis as a reference for production capacities of Eti Maden.	Yaşar, (1994)
Ibrahim Kula	Bor endüstri artıklarının cimento üretiminde katkı maddesi olarak değerlendirilmesi	2000	Sakarya University	It has been investigated that colemanite and tincal concentrator wastes and a thermal power plant wastes are re-evaluated and used as additives in cement production.	Kırka Emet Hisarcık	✓		✓		It has not been used in this review.	Kula, (2000)
Duygu Bayar	Sulu çözeltiden adsorpsiyonla bor giderimi ve deney tasarımı	2001	Osmangazi University	The removal of boron from aqueous solution with adsorption method experimentally has been investigated.	Kırka	✓	✓		✓	It has not been used in this review.	Bayar, (2001)
Çenk Bilal	Kolemanitin sülfürik asit ile reaksiyon kinetiğinin incelenmesi	2003	Istanbul Technical University	The reaction kinetics of colemanite in sulfuric acid solutions has been investigated experimentally.	Kestelek					It has not been used in this review.	Bilal, (2003)
Ozan Kökkılıç	Kırka bor işletmesi atık göletlerindeki sulardan borun kazanılması	2003	Istanbul Technical University	Chemical precipitation experiments were carried out to recover the boron in the water taken from Kırka boron plant waste lakes.	Kırka	✓		✓	✓	It has been used for the production capacities of Eti Maden.	Kökkılıç, (2003)
Caner Demir	Bor minerallerinin enerji kaynağı olarak değerlendirilmesi	2006	Selçuk University	Obtaining the elemental boron from borax was investigated experimentally.		✓	✓			It has not been used in this review.	Demir, (2006)
Orhan Yılmaz	Balıkesir-Bigadiç bor atıklarının flotasyon yöntemiyle zenginleştirilmesi çalışmaları	2006	Balıkesir University	It has not been used in this review.	Bigadiç	✓				The enrichment processes of borate minerals are used.	Yılmaz, (2006)
Bahadır Güney	Bor oksitten elementel bor tozu üretim parametrelerinin araştırılması	2007	Gazi University	In this study, elemental boron powder production parameters have been investigated experimentally.		✓				It has not been used in this review.	Güney, (2007)
Ufuk Öner	Türkiye'nin alternatif enerji kaynakları ve bor madeninin endüstride kullanım alanlarının araştırılması	2007	Istanbul Technical University	Energy resources, energy reserves, production and consumption situations have been examined in Turkey and the world.	Turkey World	✓				It has been used for the production capacities of Eti Maden and to give information about boron reserves in Turkey.	Öner, (2007)
Cihan Cantaş		2007	Osmangazi University	Elemental boron production from	Bandırma	✓					Cantaş, (2007)

(continued on next page)

Table 8 (continued)

Author	Title	Year	University	The aim of the study	Study place	Uses of boron	Mining process	Boron waste	Envir. impact	Comments	Ref.
	Magnezyum indirgemesiyle susuz borik asitten elementel bor üretimi			aqueous boric acid supplied from Bandırma Boric Acid Factory has been investigated.						It has not been used in this review.	
Elif Esin Yegül	An investigation of the methods to upgrade middlings in boron concentrators	2007	Hacettepe University	The methods of increasing the grade of low-grade B ₂ O ₃ intermediate products in Bigadiç have been investigated.	Bigadiç	✓	✓			It has been used to give information about enrichment processes.	Yegül, (2007)
Müge Yargan	Emet Espey bor tesisi ince gölet atıklarının zenginleştirme araştırılması	2007	Dumlupınar University	The enrichment of the fine (-3 mm) residues stored in the tailings dam of Espey facilities has been investigated.	Espey	✓	✓	✓		It has not been used in this review.	Yargan, (2007)
Neslihan Karaman	Emet-Hisarçık bor madeni havzasındaki suların incelenmesi	2007	Dumlupınar University	Boron and heavy metal contamination has been investigated in the waters in the boron mining areas in Turkey.	Hisarçık	✓	✓	✓	✓	It has been used for the production capacities of Eti Maden and to give information about boron reserves in Turkey.	Karaman, (2007)
Seçil Ayaz	Emet Hisarçık bor tesisi ince gölet atıklarının flotasyonla kazanılması	2007	Dumlupınar University	The enrichment of the fine (-3 mm) residues stored in the tailings dam of Emet facilities has been investigated.	Hisarçık	✓	✓	✓	✓	It has not been used in this review.	Ayaz, (2007)
Ebru Karacay	Bor karbür üretimi ve karakterizasyonu	2008	Gazi University	Boron carbide production and characterization have been carried out experimentally.		✓				It has not been used in this review.	Karacay, (2008)
İbrahim Hakkı Karakaş	Bor endüstrisi atıksularının nanofiltrasyonla arıtılabilirliğinin incelenmesi	2008	Ataturk University	Boron removal from synthetic wastewater has been investigated by nanofiltration method experimentally.		✓			✓	It has not been used in this review.	Karakaş, (2008)
Ömer Aykul	Eti Bor Emet - Hisarçık kolemanit atıklarının dekrepitasyon yöntemi ile zenginleştirilmesi	2008	Dumlupınar University	The enrichment of the fine (-3 mm) residues stored in the tailings dam of Hisarçık facilities has been investigated.	Hisarçık		✓	✓	✓	It has been used to give information about boron reserves in Turkey.	Aycul, (2008)
Ömer Faruk Gökhan Telli	Bor uç ürünleri ve üretim yöntemleri	2008	Dokuz Eylül University	The importance of boron end products, usage areas and production techniques of some products have been investigated.		✓				It has not been used in this review.	Telli, (2008)
Pelin Demirçivi	Atık suların kesikli ve sürekli sistemlerle bor giderimi	2008	Istanbul Technical University	The effects of experimental parameters on boron removal in batch and column have been investigated.		✓			✓	It has not been used in this review.	Demirçivi, (2008)
Senem Kerenciler	Emet Espey bor tesisi tesisi ince gölet atıklarının jameson flotasyon kolonunda zenginleştirilebilirliğinin araştırılması	2008	Dumlupınar University	The enrichment of the fine (-3 mm) residues stored in the tailings dam of Espey facilities has been investigated.	Espey		✓	✓	✓	It has not been used in this review.	Kerenciler, (2008)
Ayberk Muharremoğlu	Bor atıklarının pirinç dökümünde tane inceltici olarak değerlendirilmesi	2009	Yıldız Technical University	The grain refining effect of boron wastes in brass has been investigated.			✓	✓		It has not been used in this review.	Muharremoğlu, (2009)
Güneş Demirbaş	Stabilization of expansive soils using Bigadiç zeolite (boron by-product)	2009	Middle East Technical University	The effect of utilizing Bigadiç zeolite on swelling potential has been investigated.	Bigadiç		✓			It has not been used in this review.	Demirbaş, (2009)
İbrahim Atakuru	Emet ve Hisarçık bölgesi sularında arsenik ve bor tayini	2009	Dumlupınar University	The arsenic and boron contamination of the waters in the Emet-	Hisarçık	✓			✓	It has not been used in this review.	Atakuru, (2009)

(continued on next page)

Table 8 (continued)

Author	Title	Year	University	The aim of the study	Study place	Uses of boron	Mining process	Boron waste	Envir. impact	Comments	Ref.
Yiğit Kurttepe	Bor atıklarının seramik endüstrisinde değerlendirilmesi	2009	Yıldız Technical University	Hisarcık region was investigated. It is aimed to improve the mechanical and physical properties of the clay mixture used in the construction industry by adding waste pond taken from Kırka including 5 %, 10 %, 20 % and 30 % B ₂ O ₃ .	Kırka	✓	✓	✓		It has been used to give information about the enrichment process.	Kurttepe, (2009)
Zeynep Karcioğlu	Endüstriyel atıksulardan kimyasal koagülasyon yöntemi ile bor giderimi	2009	Ataturk University	The removal of boron from industrial wastewater by the chemical coagulation method and the parameters affecting this process have been investigated.		✓		✓	✓	It has not been used in this review.	Karcioğlu, (2009)
Ayça Yücel	Dünyadaki başlıca bor yatakları, üretimi, pazarlaması ve Türkiye'nin önemi	2010	Hacettepe University	Boron product types and usage areas and reserve, supply-demand, production, consumption, trade and income situations in the world boron market have been analyzed to determine the status of Turkey's importance and its place in the world boron market.	World	✓	✓			It has not been used in this review.	Yücel, (2010)
Emine Burcu Hıncalan	Bor endüstri atıklarındaki lityumun adsorpsiyon yöntemi ile kazanılması	2010	Dumlupınar University	The recovery of Lithium from the waste of Emet Boric Acid Facility has been investigated experimentally.	Emet	✓	✓	✓		It has been used to give information about facilities in Turkey.	Hıncalan, (2010)
Emrah Kılıç	Eti maden kırka bor işletmesi atıklarının analizi ve sınıflandırılması	2010	Dumlupınar University	The waste samples taken from Kırka Boron Plant have been analyzed and classified experimentally.	Kırka	✓	✓	✓		It has been used for the production capacities of Eti Maden and to give information about facilities in Turkey.	Kılıç, (2010)
Havvanur Uçbeyiay Şahinkaya	Kolemanit içeren ince boyutlu bor cevheri ve artığının zenginleştirilmesi	2010	Selçuk University	Electrokinetic, coagulation, shear flocculation and oil agglomeration properties of colemanite mineral were determined and the enrichment of fine-sized colemanite ore and plant residue has been investigated experimentally.		✓	✓			It has not been used in this review.	(Uçbeyiay Şahinkaya, 2010)
Hüseyin Şamil Koçak	Kütahya emet borik asit işletmesi bor atıklarının alçı levha üretiminde kullanılması	2010	Gazi University	The utility of boron waste of Emet Boric Acid Plant in the production of gypsum plasterboard has been investigated.	Emet	✓		✓		It has been used for the production capacities of Eti Maden.	Koçak, (2010)
İsmail Handırı	Kolemanitten amonyum tuzları, inorganik ve organik asitler kullanılarak borik asit üretimi	2010	Süleyman Demirel University	Boric acid production was investigated by the chemical leaching method using different acids and ammonium salts to concentrated colemanite and run-of-mine colemanite samples obtained from Bigadiç.	Turkey	✓	✓			It has been used for the production capacities of Eti Maden.	Handırı, (2010)

(continued on next page)

Table 8 (continued)

Author	Title	Year	University	The aim of the study	Study place	Uses of boron	Mining process	Boron waste	Envir. impact	Comments	Ref.
Osman Öner Taş	Emet Espey bor tesisi ince gölet atıklarının kolon flotasyonu ile zenginleştirilebilirliğinin araştırılması	2010	Dumlupınar University	The enrichment of the fine (–3 mm) residues stored in the tailings dam of Espey facilities has been investigated.	Espey	✓	✓	✓		It has not been used in this review.	Taş, (2010)
Soner Gökçek	Application of OHSAS 18000 Bigadiç boron work to improve the existent working conditions	2010	Middle East Technical University	Occupational Health and Safety Assessment System were implemented in Bigadiç Boron Plant.	Bigadiç		✓			It has been used for the production capacities of Eti Maden.	Gökçek, (2010)
Mesut Ak	Emet bor işletme müdürlüğü hisarcık ve espey konsantratör atıklarının mikrodalga enerjisi yardımıyla zenginleştirilebilirliğinin araştırılması	2011	Dumlupınar University	The enrichment of the fine (–3 mm) residues stored in the tailings dam of Hisarcık and Espey facilities has been investigated experimentally by using microwave energy.	Hisarcık	✓	✓	✓		It has been used to give information about the machines used during the enrichment process.	Ak, (2011)
Soner Dırak	Eti maden müdürlüğü kırka bor işletmesi bor endüstri atıklarında eser elementlerin tayini ve lityumun kazanılması	2011	Dumlupınar University	The determination of trace elements in the boron industrial wastes of Kırka Enterprise and the recovery of lithium in these wastes have been investigated.	Kırka	✓	✓	✓		It has not been used in this review.	Dirak, (2011)
Gülşah Sarıağaç	Kırka tinal bor atıklarından gözenekli agrega üretimi ve uygulamaları	2012	Afyon Kocatepe University	The use of Kırka Tincal in concrete production by producing an aggregate of different diameters from boron waste has been investigated experimentally.	Kırka	✓		✓		It has not been used in this review.	(Sarıağaç, 2012)
Mehmet Volkan Duman	Bigadiç bor işletmesi simav açık ocak taban suyundan ters osmoz yöntemi ile bor giderimi	2012	Balıkesir University	The boron removal from Simav (in Bigadiç Boron Plant) open pit base water has been investigated experimentally by reverse osmosis method	Bigadiç		✓	✓	✓	It has not been used in this review.	Duman, (2012)
Anıl Karaağaç	Endüstriyel bor atıklarından borun geri kazanımı ve nanoboroksit eldesi	2015	Balıkesir University	Obtaining nano-boron oxide from the boron waste from Bigadiç has been investigated experimentally.	Bigadiç			✓		It has not been used in this review.	Karaağaç, (2015)
Derya Ulutaş	Endüstriyel bor atıklarından borun geri kazanımı ve nanoboroksit eldesi	2015	Anadolu University	The use of the waste clay generated in Kırka Boron Plant as filling material in the production of bituminous geomembrane has been investigated.	Kırka			✓		It has not been used in this review.	Ulutaş, (2015)
Eren Bayrakçı	Bor atıklarının çöp deponi tabakalarında kullanılabilirliğinin geoteknik açıdan değerlendirilmesi	2015	Anadolu University	The use of waste clay obtained from Kırka as an impermeable layer in landfills has been investigated.	Kırka			✓		It has not been used in this review.	Bayrakçı, (2015)
Pınar Özen	Sert porselen gövdelerde bor atığı kullanımı ve karakterizasyonu	2015	Anadolu University	The use of boron waste from Kırka as a fluxing agent in hard porcelain instead of potassium feldspar has been investigated.	Kırka	✓	✓			It has not been used in this review.	Ozen, (2015)
Betül Eroğlu	Bor madenciliği atıklarının karakterizasyonu ve değerlendirilmesi	2018	Gebze Technical University	The recovery of boron from the waste of five different boron facility in Turkey have been investigated experimentally.	Turkey		✓	✓		It has been used for the production capacities of Eti Maden and to give information about boron reserves in Turkey.	Eroğlu, (2018)

(continued on next page)

Table 8 (continued)

Author	Title	Year	University	The aim of the study	Study place	Uses of boron	Mining process	Boron waste	Envir. impact	Comments	Ref.
Gülşah Koçyiğit Candar	Bor cevheri yıkama atık suyundan çöktürme ve elektrokoagülasyon yöntemleri ile borun giderimi ve geri kazanımı	2018	Ankara University	Boron removal from industrial wastewater by chemical precipitation and electrocoagulation methods and recovery by hydrothermal mineralization method have been carried out experimentally.		✓		✓		It has not been used in this review.	(Koçyiğit Candar, 2018)
Nilüfer Yavuz	Eti maden kırka bor işletmeleri, boraks penta fabrika birimlerinin risk analizinin mukayeseli olarak yapılması	2018	Dumlupınar University	Risk analysis studies were conducted for Kırka Boron Enterprise, necessary protection measures were specified and comparisons were made using risk analysis methods.	Kırka	✓	✓			It has not been used in this review.	Yavuz, (2018)
Sibel Tok	Emet kolemanit zenginleştirme tesisi düşük tenörlü konsantresinin bor içeriğinin yükseltilmesi	2018	Afyon Kocatepe University	It has been investigated to increase the boron content of low-grade concentrated colemanite in Emet enrichment plant.	Emet	✓	✓			It has been used to give general information about boron and boron facilities in Turkey.	Tok, (2018)
Cihan Mermer	Bor minerali kritikliğinin dinamik değerlendirilmesi	2018	Hacettepe University	It has been investigated how the world boron usage amounts can change in the future and how long boron reserves can be depleted considering population, marketing efficiency, global gross product, diffusion of boron mineral in the market, competition parameters in the market.		✓				It has not been used in this review.	Mermer, (2018)
Ali Ataş	Bigadiç bor açık işletmesinin bilgisayar yardımıyla modellenerek revizyonu	2019	Afyon Kocatepe University	It is aimed to calculate the reserve by modeling the Bigadiç boron field in three dimensions by using Vulcan mining software and to revise the open pit planning previously made to increase the efficiency.	Bigadiç	✓				It has not been used in this review.	Ataş, (2019)
Bahriye Eryıldız	Su-atık sulardan bor giderimi	2019	Istanbul Technical University	Boron removal from wastewater of boron mining enterprises in Turkey has been investigated experimentally.		✓	✓		✓	It has not been used in this review.	Eryıldız, (2019)
Emirhan Karadağlı	Utilization of boron mining and enrichment wastes in the production of ceramics and frits	2019	Yıldız Technical University	The use of boron waste in ceramic tile production to save energy and using boron trioxide instead of boric acid in frit production have been investigated experimentally.		✓	✓	✓		It has been used for the production capacities of Eti Maden and to give information about boron facilities in Turkey.	Karadağlı, (2019)
Süleyman Sırrı Sargın	Emet bor işletme müdürlüğü Espey açık ocak işletmesinin iş sağlığı ve güvenliğinin farklı risk değerlendirme yöntemleri ile analizi	2019	Dumlupınar University	Risk analysis in Espey Open Pit was conducted with the L Type Matrix method and Fine-Kinney method.	Emet	✓	✓			It has been used to give information about the machines used during the mining activity.	Sargın, (2019)
Argun Türker	Bor minerallerinde eser element tayini	2020	Gazi University	Trace elements have been studied in colemanite, tincal and		✓		✓		It has not been used in this review.	Türker, (2020)

(continued on next page)

Table 8 (continued)

Author	Title	Year	University	The aim of the study	Study place	Uses of boron	Mining process	Boron waste	Envir. impact	Comments	Ref.
Reyhan Özbaşı	Bor atıklarından kıymetli metallerin geri kazanılması	2020	Yıldız Technical University	ulexite and boron wastes. The recovery of precious metals such as lithium and rubidium detected in the content of different ore and waste clay samples of Eti Maden has been investigated experimentally.	Kırka	✓		✓	✓	It has not been used in this review.	Ozbaşı, (2020)
Sinem Harbili Çolak	Kolemanit atıklardan kimyasal liç yöntemiyle bor türlevlerinin eldesi	2020	Çanakkale Onsekiz Mart University	It has been researched to obtain boric acid by recovered colemanite wastes by chemical leaching method experimentally.	Çanakkale	✓				It has been used to give information about refined products in Turkey.	HARBİLİ ÇOLAK, (2020)
Zehra Betül Öcal Sarıhan	Sulardan bor giderimi ve elde edilen çamurdan katma değeri yüksek ürün geri kazanımı ile sürdürülebilir bir proses geliştirilmesi	2020	Gebze Technical University	Alternative processes that can provide boron recovery from wastewater of boron facilities, the usability of these processes and the efficiency of the methods have been investigated experimentally.	Bandırma	✓			✓	It has been used for the production capacities of Eti Maden.	Sarıhan, (2019)

Table 9

Ph.D. theses related to boron mining.

Author	Title	Year	University	The aim of the study	Study place	Uses of boron	Mining process	Boron waste	Envir. impact	Comments	Ref.
Gülser Gür	Tincal cevherinden bor tuzları üretiminde safsızlıkların flokulasyon davranışları	1995	Istanbul Technical University	The flocculation of water-insoluble impurities inside the tincal ore during the production of tincal concentrate, borax decahydrate and borax pentahydrate has been investigated experimentally.	Kırka		✓			It has not been used in this review.	GÜR, (2013)
Alper Erdem Yılmaz	Endüstriyel atık sulardan elektrokoagülasyon yöntemi ile bor giderimi	2009	Ataturk University	The recovery of boron from industrial wastewater with the electrocoagulation method and the parameters affecting this process have been investigated.		✓		✓	✓	It has not been used in this review.	YILMAZ, (2009)
Ayşegül Türk	Eti maden kırka bor işletmesi atıklarından rubidyumun kazanılması	2012	Dumlupınar University	The recovery of rubidium from the waste of Eti Maden Kırka Boron Plant has been researched.	Kırka	✓	✓	✓		It has not been used in this review.	TÜRK, (2012)
Ferda Özmal	Hisarcık-Espey bölgesi bor endüstri atıklarında eser elementlerin tayini ve lityumun değerlendirilmesi	2012	Dumlupınar University	It has been investigated to recover lithium from the waste of Emet boric acid factory by characterizing	Hisarcık	✓	✓			It has not been used in this review.	ÖZMAL, (2012)

(continued on next page)

Table 9 (continued)

Author	Title	Year	University	The aim of the study	Study place	Uses of boron	Mining process	Boron waste	Envir. impact	Comments	Ref.
Bengü Ertan	Hisarcık – Espey bölgesi bor killerinde eser elementlerin tayini ve rubidyumun kazanılması	2013	Dumlupınar University	borogypsin in the waste. The recovery of rubidium from the waste of Eti Maden Hisarcık Boron Plant has been researched.	Hisarcık	✓		✓		It has been used to give information about boron reserves and boron products.	Ertan, (2013)
Emel Özder	Bigadiç bor işletmesi endüstri atıklarının değerlendirilmesi	2013	Dumlupınar University	By characterizing and classifying the solid wastes of Bigadiç Boron Industry, it has been researched its usability in the porcelain industry and its usability for lithium carbonate production.	Bigadiç	✓	✓	✓		It has not been used in this review.	Özder, (2013)
Tanju Başaran	Kırka (Eskişehir) bor işletmesinin toprak ve sular üzerindeki çevresel etkilerinin incelenmesi	2015	Hacettepe University	Potential negative effects of Kırka Boron Enterprise on the environment, soil and water have been investigated.	Kırka		✓	✓	✓	It has not been used in this review.	Başaran, (2015)
Emin Ender Çelebi	Bor endüstrisi atıksularından sıvı ekstraksiyonu yöntemi ile lityum kazanımı	2019	Gebze Technical University	The application of the liquid extraction method for lithium recovery from Kırka boron industry wastewater has been studied.	Kırka		✓			It has not been used in this review.	Çelebi, (2019)

Table 10

Reports related to boron mining.

Author	Title	Year	Content	Study place	Uses of boron	Mining details	Boron waste	Envir. impact	Comment	Ref.
State Planning Organization (Turkey)	Bor Bileşikleri	1987	The general information about the boron products, production methods of refined boron products, market, the exportation of boron, and the production capacity and production amount of facilities in years in Turkey has been given.	Turkey	✓				It has been used for the production capacities of Eti Maden, to give information and data about production process of refined products.	(Türkiye Cumhuriyeti Başbakanlık Devlet Planlama Teşkilatı, 1987)
State Planning Organization (Turkey)	Madencilik Özel İhtisas Komisyonu Raporu	2001	The general information about the boron products, the inputs used for the open-pit mining and enrichment processes, market, the exportation of boron, and the production capacity and production amount of facilities in years, the amount of overburdens in Turkey has been given.	Turkey	✓	✓			It has been used for the production capacities of Eti Maden and the inputs for open-pit-mining and borate enrichment process.	(Türkiye Cumhuriyeti Başbakanlık Devlet Planlama Teşkilatı, 2001)
Türk Mühendis ve Mimar Odaları Birliği	Boron Report	2003	The general information about the boron products, market, facilities, and the production capacity of	Turkey	✓	✓		✓	It has been used for the production capacities of Eti Maden	(Türk Mühendis ve Mimar Odaları Birliği, 2003)

(continued on next page)

Table 10 (continued)

Author	Title	Year	Content	Study place	Uses of boron	Mining details	Boron waste	Envir. impact	Comment	Ref.
Eti Mining Operations General Directorate	Annual Report	2006	facilities in Turkey has been given. The general information about the boron products, market, facilities, and the production capacity of facilities in Turkey has been given.	Turkey	✓				It has been used for the production capacities of Eti Maden	Eti Mining Operations General Directorate, (2006)
Eti Mining Operations General Directorate	Annual Report	2008	The general information about the boron products, market and facilities in Turkey has been given.	Turkey	✓				It has been used for the production capacities of Eti Maden	Eti Mining Operations General Directorate, (2008)
Eti Mining Operations General Directorate	Annual Report	2009	The general information about the boron products, market and facilities in Turkey has been given.	Turkey	✓				It has been used for the production capacities of Eti Maden	Eti Mining Operations General Directorate, (2009)
Eti Mining Operations General Directorate	Sector Report	2010	The production capacity of facilities in Turkey has been given.	Turkey	✓				It has been used for production capacities of Eti Maden	Eti Mining Operations General Directorate, (2010)
Eti Mining Operations General Directorate	Annual Report	2012	The general information about the boron products, market and facilities in Turkey has been given.	Turkey	✓				It has been used for production capacities of Eti Maden.	Eti Mining Operations General Directorate, (2012)
Eti Mining Operations General Directorate	Annual Report	2013	The general information about the boron products, market and facilities in Turkey has been given.	Turkey	✓				It has been used for production capacities of Eti Maden.	Eti Mining Operations General Directorate, (2013)
Eti Mining Operations General Directorate	Annual Report	2016	The general information about the boron products, market and facilities in Turkey has been given in detail.	Turkey	✓				It has been used for production capacities of Eti Maden.	Eti Mining Operations General Directorate, (2016)
Türk Mühendis ve Mimar Odaları Birliği	Boron Report	2016	The general information about the boron products, market, and the production capacity of facilities in Turkey has been given.	Turkey	✓				It has been used for production capacities of Eti Maden	Eti Mining Operations General Directorate, (2016)
Eti Mining Operations General Directorate	Sector Report	2017	The general information about the boron products, market and facilities in Turkey has been given.	Turkey	✓				It has not been used in this review.	Eti Mining Operations General Directorate, (2017)
Eti Mining Operations General Directorate	Sector Report	2018	The general information about the boron products, market and facilities in Turkey has been given.	Turkey	✓				It has not been used in this review.	Eti Mining Operations General Directorate, (2018)
Eti Mining Operations General Directorate	Sector Report	2020	The general information about the boron products, market in Turkey has been given.	Turkey	✓				It has been used for the amount of borate deposits in Turkey.	Eti Mining Operations General Directorate, (2020)

References

- Ak, M., 2011. Emet Bor İşletme Müdürlüğü Hisarcık Ve Espey Konsantrör Atıklarının Mikrodalga Enerjisi Yardımıyla Zenginleştirilebilirliğinin Araştırılması. Dumlupınar University, Kütahya, Turkey.
- Atakuru, I., 2009. Emet Ve Hisarcık Bölgesi Sularında Arsenik Ve Bor Tayini. Dumlupınar University, Kütahya, Turkey.
- Ataş, A., 2019. Bigadiç Bor Açık İşletmesinin Bilgisayar Yardımıyla Modellenerek Revizyonu. Afyon Kocatepe University, Afyonkarahisar, Turkey.
- Ayaz, S., 2007. Emet Hisarcık Bor Tesisi İnce Gölet Atıklarının Flotasyonla Kazanılması. Dumlupınar University, Kütahya, Turkey.
- Aykol, O., 2008. Eti Bor Emet-Hisarcık Kolemanit Atıklarının Dekrepatasyon Yöntemi İle Zenginleştirilmesi. Dumlupınar University, Kütahya, Turkey.
- Azapagic, A., 1999. Life cycle assessment and its application to process selection, design and optimisation. Chem. Eng. J. 73, 1–21.
- Başaran, T., 2015. Kırka (Eskişehir) Bor İşletmesinin Toprak Ve Sular Üzerindeki Çevresel Etkilerinin İncelenmesi. Hacettepe University, Ankara, Turkey.
- Bayar, D., 2001. Sulu Cözeltiden Adsorpsiyonla Bor Giderimi Ve Deney Tasarımı. Osmangazi University, Eskişehir, Turkey.
- Bayrakçı, E., 2015. Bor Atıklarının Çöp Deponi Tabakalarında Kullanılabilirliğinin Geoteknik Açısından Değerlendirilmesi. Anadolu University, Eskişehir, Turkey.

- Bilal, C., 2003. Kolemanitin Sülfürük Asit İle Reaksiyon Kinetiğinin İncelenmesi. İstanbul Technical University, İstanbul, Turkey.
- Bongono, J., Elevli, B., Laratte, B., 2020. Functional unit for impact assessment in the mining sector—Part 1. Sustainability 12, 9313.
- Boren, n.d.
- Cantaş, C., 2007. Magnezyum İndirgemeyle Susuz Borik Asitten Elementel Bor Üretimi. Osmangazi University, Eskişehir, Turkey.
- Çelebi, E.E., 2019. Bor Endüstrisi Atıklarından Sıvı Ekstraksiyonu Yöntemi İle Lityum Kazanımı. Gebze Technical University, Gebze, Turkey.
- Çolak, A., Laratte, B., Elevli, B., Çoruh, S., 2022. Abiotic depletion of boron: an update characterization factors for CML 2002 and ReCiPe. Minerals 12. <https://doi.org/10.3390/min12040435>.
- Demir, C., 2006. Bor Minerallerinin Enerji Kaynağı Olarak Değerlendirilmesi. Selçuk University, Konya, Turkey.
- Demirbaş, G., 2009. Stabilization of Expansive Soils Using Bigadiç Zeolite. Middle East Technical University, Ankara, Turkey.
- Demirçivi, P., 2008. Atık Sulardan Kesikli Ve Sürekli Sistemlerle Bor Giderimi. İstanbul Technical University, İstanbul, Turkey.
- Dirak, B., 2011. Eti Maden Müdürlüğü Kırka Bor İşletmesi Bor Endüstri Atıklarında Eser Elementlerin Tayini Ve Lityumun Kazanılması. Dumlupınar University, Kütahya, Turkey.
- Duman, M.V., 2012. Bigadiç Bor İşletmesi Simav Açık Ocak Taban Suyundan Ters Osmoz Yöntemi İle Bor Giderimi. Balıkesir University, Balıkesir, Turkey.
- Durmaz, K., 2018. Eti Maden İşletmeleri Hisarcık Barajı Atıklarının Seramik Sektöründe Kullanılabilirliğinin Araştırılması. Dumlupınar University, Kütahya, Turkey.
- Elevli, B., Yaman, İ., Laratte, B., 2022. Estimation of the Turkish boron exportation to Europe. Mining 2. <https://doi.org/10.3390/mining2020009>.
- Eroğlu, B., 2018. Bor Madenciligi Atıklarının Karakterizasyonu Ve Değerlendirilmesi. Gebze Technical University, Gebze, Turkey.
- Ertan, B., 2013. Hisarcık – Esey Bölgesi Bor Killerinde Eser Elementlerin Tayini Ve Rubidyumun Kazanılması. Dumlupınar University, Kütahya, Turkey.
- Eryıldız, B., 2019. Su-atık Sulardan Bor Giderimi. İstanbul Technical University, İstanbul, Turkey.
- Eti Mining Operations General Directorate, 2020. Eti Mine Works General Directorate Sector Report. Eti Mining Operations General Directorate, Ankara, Turkey.
- Eti Mining Operations General Directorate, 2019. Eti Mine Works General Directorate Sector Report. Eti Mining Operations General Directorate, Ankara, Turkey.
- Eti Mining Operations General Directorate, 2018. Eti Mine Works General Directorate Sector Report. Eti Mining Operations General Directorate, Ankara, Turkey.
- Eti Mining Operations General Directorate, 2017. Eti Mine Works General Directorate Sector Report. Eti Mining Operations General Directorate, Ankara, Turkey.
- Eti Mining Operations General Directorate, 2016. Eti Mine Works General Directorate Sector Report. Eti Mining Operations General Directorate, Ankara, Turkey.
- Eti Mining Operations General Directorate, 2013. Eti Mine Works General Directorate Annual Report. Eti Mining Operations General Directorate, Ankara, Turkey.
- Eti Mining Operations General Directorate, 2012. Eti Mine Works General Directorate Annual Report. Eti Mining Operations General Directorate, Ankara, Turkey.
- Eti Mining Operations General Directorate, 2010. Eti Mine Works General Directorate Annual Report. Eti Mining Operations General Directorate, Ankara, Turkey.
- Eti Mining Operations General Directorate, 2009. Eti Mine Works General Directorate Annual Report. Eti Mining Operations General Directorate, Ankara, Turkey.
- Eti Mining Operations General Directorate, 2008. Eti Mine Works General Directorate Annual Report. Eti Mining Operations General Directorate, Ankara, Turkey.
- Eti Mining Operations General Directorate, 2006. Eti Mine Works General Directorate Annual Report. Eti Mining Operations General Directorate, Ankara, Turkey.
- Eti Mining Operations General Directorate, 2005. Eti Mine Works General Directorate Annual Report. Eti Mining Operations General Directorate, Ankara, Turkey.
- Etimaden, n.d. Eti Maden Operations General Directorate.
- European Commission, 2014. Report on Critical Raw Materials for the EU; Critical Raw Materials Profiles.
- Farjana, S.H., Huda, N., Mahmud, M.P., Lang, C., 2019. A global life cycle assessment of manganese mining processes based on Ecoinvent database. Sci. Total Environ. 688, 1102–1111.
- Ferreira, H., Leite, M.G.P., 2015. A Life Cycle Assessment study of iron ore mining. J. Clean. Prod. 108, 1081–1091.
- Frischnecht, R., Jungbluth, N., Althaus, H.-J., Doka, G., Dones, R., Heck, T., Hellweg, S., Hischer, R., Nemecek, T., Rebitzer, G., 2005. The ecoinvent database: overview and methodological framework (7 pp). Int. J. Life Cycle Assess. 10, 3–9.
- Gökçek, S., 2010. Application of OHSAS 18000 to Bigadiç Boron Work to Improve the Existing Working Conditions. Middle East Technical University, Ankara, Turkey.
- Güney, B., 2007. Bor Oksitten Elementel Bor Tozu Üretim Parametrelerinin Araştırılması. Gazi University, Ankara, Turkey.
- Gür, G., 2013. Tinkal Cevherinden Bor Tuzları Üretiminde Safsızlıkların Flokulasyon Davranışları. İstanbul Technical University, İstanbul, Turkey.
- Güyagüler, T., 2001. Türkiye bor potansiyeli, 4. Endüstriyel Hammaddeler Sempozyumu 18–19.
- Handırı, I., 2010. Kolemaniten Amonyum Tuzları, İnorganik Ve Organik Asitler Kullanılarak Borik Asit Üretimi. Süleyman Demirel University, Isparta, Turkey.
- Harbili Çolak, S., 2020. Kolemanit Atıklardan Kimyasal Liç Yöntemiyle Bor Türevlerinin Eldesi. Çanakkale Onsekiz Mart University, Çanakkale, Turkey.
- Helvacı, C., 2017. Borate deposits: an overview and future forecast with regard to mineral deposits. Bor Dergisi 2, 59–70.
- Helvacı, C., 2003. Türkiye borat yatakları jeolojik konumu, ekonomik önemi ve bor politikası. Balıkesir Üniversitesi Fen Bilimleri Enstitüsü Dergisi 5, 4–41.
- Hıncalan, E.B., 2010. Bor Endüstri Atıklarındaki Lityumun Adsorpsiyon Yöntemi İle Kazanılması. Dumlupınar University, Kütahya, Turkey.
- Karaağaç, A., 2015. Endüstriyel Bor Atıklarından Borun Geri Kazanımı Ve Nanoboroksit Eldesi. Balıkesir University, Balıkesir, Turkey.
- Karaçay, E., 2008. Bor Karbür Üretimi Ve Karakterizasyonu. Gazi University, Ankara, Turkey.
- Karadağlı, E., 2019. Utilization of Boron Mining and Enrichment Wastes in the Production of Ceramics and Frits. Yıldız Technical University, İstanbul, Turkey.
- Karakaş, I.H., 2008. Bor Endüstrisi Atıklarının Nanofiltrasyonla Arıtılabilirliğinin İncelenmesi. Atatürk University, Erzurum, Turkey.
- Karaman, N., 2007. Emet-Hisarcık Bor Madeni Havzasındaki Suların İncelenmesi. Dumlupınar University, Kütahya, Turkey.
- Karçoğlu, Z., 2009. Endüstriyel Atıksulardan Kimyasal Koagülasyon Yöntemi İle Bor Giderimi. Atatürk University, Erzurum, Turkey.
- Keremci, S., 2008. Emet Esey Bor Tesisi Tesisi İnce Gölet Atıklarının Jameson Flotasyon Kolonunda Zenginleştirilebilirliğinin Araştırılması. Dumlupınar University, Kütahya, Turkey.
- Kılıç, E., 2010. Eti Maden Kırka Bor İşletmesi Atıklarının Analizi Ve Sınıflandırılması. Dumlupınar University, Kütahya, Turkey.
- Kılıç, E., Mordoğan, H., Tanrıverdi, M., 2001. Bor minerallerinin önemi, potansiyeli, üretimi ve ekonomisi. Endüstriyel Hammaddeler Sempozyumu 18–19.
- Koçak, H.Ş., 2010. Kütahya Emet Borik Asit İşletmesi Bor Atıklarının Alçı Levha Üretiminde Kullanılması. Gazi University, Ankara, Turkey.
- Koçyiğit Candar, G., 2018. Bor Cevheri Yıkama Atık Suyundan Çöktürme Ve Elektrokoagülasyon Yöntemleri İle Borun Giderimi Ve Geri Kazanımı. Ankara University, Ankara, Turkey.
- Kökülcü, O., 2003. Kırka Bor İşletmesi Atık Göletlerindeki Sulardan Borun Kazanılması. İstanbul Technical University, İstanbul, Turkey.
- Kotu, V., Deshpande, B., 2019. Chapter 2 - data science process. In: Kotu, V., Deshpande, B. (Eds.), Data Science, second ed. Morgan Kaufmann, pp. 19–37. <https://doi.org/10.1016/B978-0-12-814761-0.00002-2>.
- Kula, I., 2000. Bor Endüstri Artıklarının Cimento Üretiminde Katkı Maddesi Olarak Değerlendirilmesi. Sakarya University, Sakarya, Turkey.
- Kurttepe, Y., 2009. Bor Atıklarının Seramik Endüstrisinde Değerlendirilmesi. Yıldız Technical University, İstanbul, Turkey.
- Leroy, Y., 2009. Développement d'une méthodologie de fiabilisation des prises de décisions environnementales dans le cadre d'analyses de cycle de vie basée sur l'analyse et la gestion des incertitudes sur les données d'inventaires.
- Mermer, C., 2018. Bor Minerali Kritikliğinin Dinamik Değerlendirilmesi. Hacettepe University, Ankara, Turkey.
- Muharremoğlu, A., 2009. Bor Atıklarının Pirinç Dökümünde Tane İnceltici Olarak Değerlendirilmesi. Yıldız Technical University, İstanbul, Turkey.
- Oner, U., 2007. Türkiye'nin Alternatif Enerji Kaynakları Ve Bor Madeninin Endüstride Kullanım Alanlarının Araştırılması. İstanbul Commerce University, İstanbul, Turkey.
- Ozbaş, R., 2020. Bor Atıklarından Kıymetli Metallerin Geri Kazanılması. Yıldız Technical University, İstanbul, Turkey.
- Ozder, E., 2013. Bigadiç Bor İşletmesi Endüstri Atıklarının Değerlendirilmesi. Dumlupınar University, Kütahya, Turkey.
- Ozen, P., 2015. Sert Porselen Gövdelerde Bor Atığı Kullanımı Ve Karakterizasyonu. Anadolu University, Eskişehir, Turkey.
- Ozmal, F., 2012. Hisarcık-Esey Bölgesi Bor Endüstri Atıklarında Eser Elementlerin Tayini Ve Lityumun Değerlendirilmesi. Dumlupınar University, Kütahya, Turkey.
- Sargın, S.S., 2019. Emet Bor İşletme Müdürlüğü Esey Açık Ocak İşletmesinin İş Sağlığı Ve Güvenliğinin Farklı Risk Değerlendirme Yöntemleri İle Analizi. Dumlupınar University, Kütahya, Turkey.
- Sarıağaç, G., 2012. Kırka Tinkal Bor Atıklarından Gözenekli Agrega Üretimi Ve Uygulamaları. Afyon Kocatepe University, Afyonkarahisar, Turkey.
- Sarıhan, Z.B.O., 2019. Sulardan Bor Giderimi Ve Elde Edilen Çamurdan Katma Değeri Yüksek Ürün Geri Kazanımı İle Sürdürülebilir Bir Proses Geliştirilmesi. Gebze Technical University, Gebze, Turkey.
- Şensoy, A.N., Özgün, M.A., Akçıl, A.U., n.d. Eti Maden İşletmeleri Kırka Bor İşletme Müdürlüğü Tanıtımı.
- Size, E.O.M., 2019. Share & Trends Analysis Report by Application (Cleaning & Home, Medical, Food & Beverages, Spa & Relaxation), by Product, by Sales Channel, and Segment Forecasts, pp. 2019–2025. Report ID 978–1.
- Taner, A., 1985. Organik ve anorganik bor bileşikler. Etibank Bülteni 74, 20–28.
- Taş, O.O., 2010. Emet Esey Bor Tesisi İnce Gölet Atıklarının Kolon Flotasyonu İle Zenginleştirilebilirliğinin Araştırılması. Dumlupınar University, Kütahya, Turkey.
- Telli, O.F.G., 2008. Bor Uç Ürünleri Ve Üretim Yöntemleri. Dokuz Eylül University, İzmir, Turkey.
- The Statistics Portal, n.d. World Boron Reserves as of 2015, by Major Countries, by major countries (in 1,000 metric tons).
- Tok, S., 2018. Emet Kolemanit Zenginleştirme Tesisi Düşük Tenörlü Konsantrasyonun Bor İçeriğinin Yükseltmesi. Afyon Kocatepe University, Afyonkarahisar, Turkey.
- Türk, A., 2012. Eti Maden Kırka Bor İşletmesi Atıklarından Rubidyumun Kazanılması. Dumlupınar University, Kütahya, Turkey.
- Türk Mühendis ve Mimar Odaları Birliği, 2016. Türk Mühendis ve mimar Odaları Birliği boron report. Türk Mühendis ve Mimar Odaları Birliği.
- Türk Mühendis ve Mimar Odaları Birliği, 2003. Türk Mühendis ve Mimar Odaları Birliği Boron Report. Türk Mühendis ve Mimar Odaları Birliği, Ankara, Turkey.
- Turbay, T., Laratte, B., Çolak, A., Çoruh, S., Elevli, B., 2022. Life cycle assessment of boron industry from mining to refined products. Sustainability 14. <https://doi.org/10.3390/su14031787>.
- Türker, A., 2020. Bor Minerallerinde Eser Element Tayini. Gazi University, Ankara, Turkey.
- Türkiye Cumhuriyeti Başbakanlık Devlet Planlama Teşkilatı, 2001. Madencilik Özel İhtisas Komisyonu Raporu. Türkiye Cumhuriyeti Başbakanlık Devlet Planlama Teşkilatı.

- Türkiye Cumhuriyeti Başbakanlık Devlet Planlama Teşkilatı, 1987. Kimya Sektörü Özel İhtisas Komisyonu Bor Bileşikleri Alt Komisyon Raporu. Türkiye Cumhuriyeti Başbakanlık Devlet Planlama Teşkilatı.
- Uçbeyiyay Şahinkaya, H., 2010. Kolemanit İçeren İnce Boyutlu Bor Cevheri Ve Artığının Zenginleştirilmesi. Selçuk University, Konya, Turkey.
- Ulutaş, D., 2015. Bor Atıklarının Katı Atık Düzenli Depolama Tesislerinde Geomembran Tabaka Olarak Kullanımı. Anadolu University, Eskişehir, Turkey.
- Weidema, B.P., 1998. Multi-user test of the data quality matrix for product life cycle inventory data. *Int. J. Life Cycle Assess.* 3, 259–265.
- Weidema, B.P., Bauer, C., Hischier, R., Mutel, C., Nemecek, T., Reinhard, J., Vadenbo, C., Wernet, G., 2013. Overview and Methodology: Data Quality Guideline for the Ecoinvent Database Version 3.
- Weidema, B.P., Wesnaes, M.S., 1996. Data quality management for life cycle inventories—an example of using data quality indicators. *J. Clean. Prod.* 4, 167–174.
- Yargan, M., 2007. Emet Espey Bor Tesisi İnce Gölet Atıklarının Zenginleştirme Araştırılması. Dumlupınar University, Kütahya, Turkey.
- Yaşar, E., 1994. Bor Minerallerinin Elektrostatik Ve Elektrokinetik Özellikleri. Istanbul Technical University, Istanbul, Turkey.
- Yavuz, N., 2018. Eti Maden Kırka Bor İşletmeleri, Boraks Penta Fabrika Birimlerinin Risk Analizinin Mukayeseli Olarak Yapılması. Dumlupınar University, Kütahya, Turkey.
- Yegül, E.E., 2007. Bor Zenginleştirme Tesislerinde Aratürün Tenörlerinin Arttırılması İçin Yöntemlerin İncelenmesi. Hacettepe University, Ankara, Turkey.
- Yenmez, N., 2009. Stratejik bir maden olarak bor minerallerin Türkiye için önemi. *Coğrafya Dergisi* 59–94.
- Yılmaz, A.E., 2009. Endüstriyel Atık Sulardan Elektrokoagülasyon Yöntemi İle Bor Giderimi. Ataturk University, Erzurum, Turkey.
- Yılmaz, O., 2006. Balıkesir-Bigadiç Bor Atıklarının Flotasyon Yöntemiyle Zenginleştirilmesi Çalışmaları. Balıkesir University, Balıkesir, Turkey.
- Yücel, A., 2010. Dünyadaki Başlıca Bor Yatakları, Üretimi, Pazarlaması Ve Türkiye'nin Önemi. Hacettepe University, Ankara, Turkey.
- Zeki, A., 1985. Etibank Boraks Fabrikası Atıklarından, Ham Boraks, Saf Boraks, Borik Asit, Perborat Üretim Şartlarının Araştırılması. Istanbul University, Istanbul, Turkey.