



### **Science Arts & Métiers (SAM)**

is an open access repository that collects the work of Arts et Métiers Institute of Technology researchers and makes it freely available over the web where possible.

This is an author-deposited version published in: <https://sam.ensam.eu>  
Handle ID: <http://hdl.handle.net/10985/23424>

#### **To cite this version :**

Patrice DUBOIS, Améziane AOUSSAT, Lien LUONG - Proposal of a Tool to Formalize User needs for the Design of Experimental Systems - Asian International Journal of Science and Technology in Production and Manufacturing Engineering - Vol. 2, n°1, p.75-88 - 2009

Any correspondence concerning this service should be sent to the repository

Administrator : [scienceouverte@ensam.eu](mailto:scienceouverte@ensam.eu)



# Proposal of a Tool to Formalize User needs for the Design of Experimental Systems

**Dubois P.\***

*Product Design and Innovation Laboratory, Arts et Métiers ParisTech,  
151 Boulevard de l'Hôpital, Paris 75013, France, patrice.dubois@ensam.eu*

**Aoussat A.**

*Product Design and Innovation Laboratory, Arts et Métiers ParisTech,  
151 Boulevard de l'Hôpital, Paris 75013, France, ameziane.aoussat@ensam.eu*

**Luong L.**

*Product Design and Innovation Laboratory, Arts et Métiers ParisTech,  
151 Boulevard de l'Hôpital, Paris 75013, France, luonglien@hotmail.com*

## **Abstract**

*This paper deals with the design of experimental systems, which are necessary to the study and understanding of new phenomena. Usually, the design of such systems depends on two persons, the researcher and the designer, who communicate to define requirements. Because the phenomenon under study is little known or unknown, the requirements are not precisely defined. This implies bad system quality, high costs and long production time. Our approach puts together the researcher and the designer. Existing product design methods do not take into account to user needs. That is why, in our study we came up with a methodology that will facilitate contact between the researcher and the designer by building a common ground on which both parties could optimally work. Our approach guarantees a good design from the first attempt. We simply based our proposed method on an experiment using a project brief which changes according to the evolution of the project itself. Such an approach takes into consideration all technical constraints that might be connected to the particular project at hand. We illustrate our approach with an example*

**Keywords:** *Design, System of experiments, methodology, Analysis of factors*

## **1 Introduction**

Experimentation systems necessary for the study and comprehension of new phenomena are specific products. In general, the design of such systems relies on in design teams made up of two main actors: the researcher and the designer. Because of the lack of control of the phenomenon being studied, exchanges between these two actors lack in precision, thus inducing many uncertainties, in particular on the level of planning experimental

conditions. This inaccuracy results in the non-observance of quality, costs and deadlines.

In this article, we present the importance of experimental systems and how those contribute to the exploration of phenomena being studied. Nevertheless, the complexity of the relationship between researcher and designer lead them to design experimentation systems which are sometimes ineffective. In order to mitigate this deficiency, we propose a tool named Anexof to facilitate exchange between these two actors. The main goal is to allow

optimal planning of experimental conditions, in order to reach a compromise taking into account the various constraints these project actors impose on one another. This tool, which is better adapted to the design of experimentation systems ensures the design "good first time", and is based on an exhaustive analysis of experimentation tasks. An application of this tool will be presented to illustrate its relevance and its advantages.

## 2 Experimental systems

### 2.1 Importance of experimental systems in research

An experimental system (ES) is a complete unit, which is used to carry out one or more experiments. Such systems include testing grounds, testing machinery and all other types of experimental equipment. All ES integrate specificities of their field of application. One can classify them according to three families:

- 1st family: test protocols are known and standards are widely used. The experimental systems are developed in large series by the industry. We will call these *specific experimental systems*.

- 2nd family: experimental systems using special standards: these involve new experiments and applications in research projects in very specific areas.
- 3rd family: a combination of the two first families. ESs of the first family are amended or supplemented to suit the desired experiment. These are called the hybrid SEs.

Contrary to standard experimental systems (designed for repeated use), specific and hybrid ESs are intended for specific projects and often have a short lifespan. As much as possible, their structure consists in a maximum of standard components allowing development delays to be shortened. specific ES are developed in a unitary way or in very small series. Development constraints do not allow the use of manufacturing processes in great series.

In this paper, we were interested exclusively in the two last families and will call thereafter them ESs distinct from the ES which refer to experimentation systems in general. In France, very few companies are equipped with laboratories with experts in the development with of experimentation systems. Their activities are directed towards certain sectors which are very developed such as for example nuclear physics, or the oil or automotive industries.

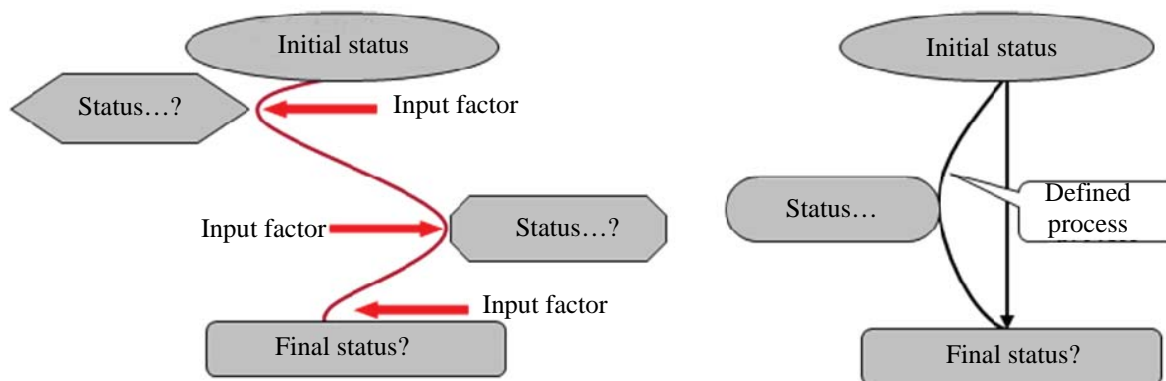

**Figure 1:** State changes in an ESs and in special machinery

To overcome this problem, new innovative enterprises (including ESs) use testing laboratories or public/academic research structures. The two main actors in the design of the ES are the researcher and engineer. The latter designs the experimental system. Our study focuses on this context.

The user of the device is the experimenter: an experimental system is designed to create a phenomenon in order to observe its development, from the initial state to the end state (see Figure 1) [1]. The characteristics of the ES are related to the unpredictable aspect of the phenomenon being studied. The purpose of the experiment is to study a

phenomenon which is unknown or little known, in which interactions between different parameters often result in surprising outcomes. The experimental system must respect the natural development of these phenomena and take account of the factors influencing them, unlike special machine where only the end result is important. For example, a machine shearing test is different from a cutting machine by shearing.

## 2.2 Positioning systems in an experimental research

Positioning experimental systems within a protocol for experimental research is a basic component of scientific research based on systematic experimentation. It is a pragmatic, but structured, approach [1,2].

Experimental science proceeds according to four steps: “one starts from a problematic fact, one poses an assumption, one seeks to test the assumption through experimentation and from there, results in new facts, and so on [3].

Jack GOUPY [4] characterized this process of knowledge acquisition in 4 steps:

1. Formalization of the questions and problems. An exploratory phase makes it possible to raise questions about the subject in which one is interested in order to lay down the goals of the study
  2. Inventory of information - Hypothesis
  3. Experimentation
- Acquisition of knowledge–perspectives for future work

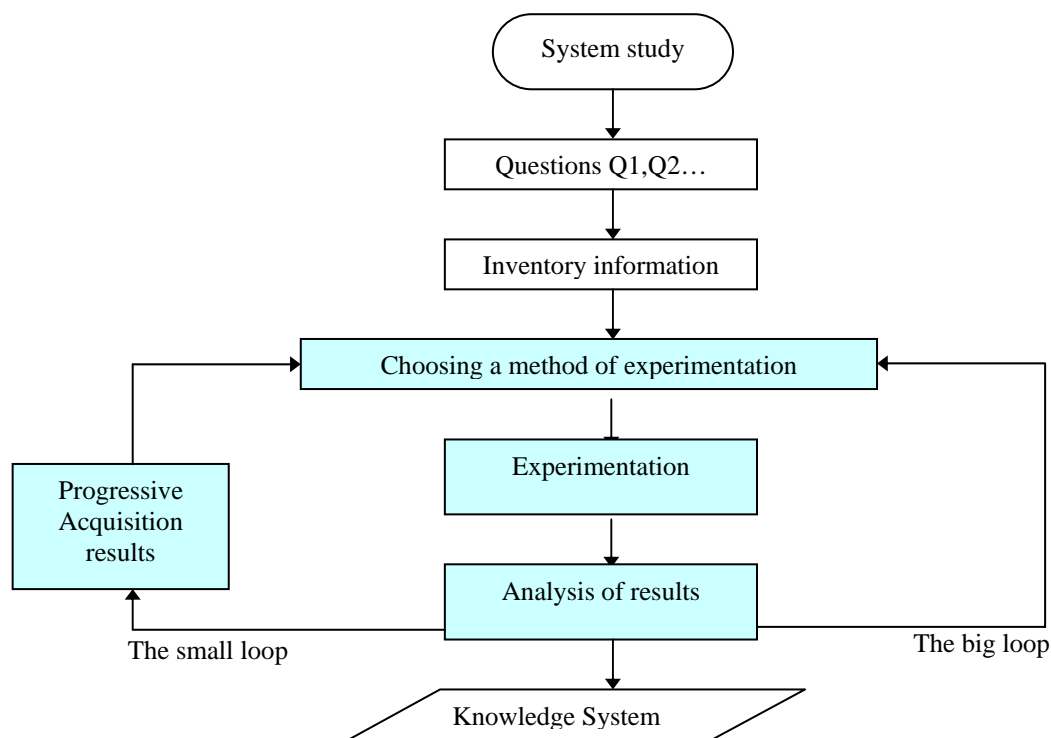

**Figure 2:** Knowledge acquisition process according to [4]

We note that in this process, the testing phase is crucial. It acts as a tool of discovery, evaluation and validation. It also fits in with standards used in the design of products and processes [5]. The experiment is also considered a method of optimization [6,7].

## 2.3 Difficulties encountered by the researchers and the designers

In order to better understand difficulties related to the design of experimental systems (as well as to the planning of experimental conditions), an investigation carried out in 2001 highlighted that

budgets are often stretched; experiments can be carried out as part of a thesis or doctorate. Two major constraints can be identified. Firstly, needs in terms of ES design are very often badly defined owing to the fact that one often does not know the reaction of the experiment which one considers; secondly, it's not designers who carry out these ESs but researchers who also take on the role of designer (often alongside the experimenter) [8]. Paradoxically, the laboratories involved do not use standards in product design [5]. They consider them badly adapted to their needs.

In ESs development, incomprehension between the researcher and the designer is the cause of shifts between the end result and initial needs and expectations. One of the conclusions of this study relates to the following question: How can the researcher and the designer co-construct a full and relevant scope statement?

### **3 Proposal of a tool to formalize requirements: ANEXOF**

The proposed tool is called Anexof (in French): functional analysis of the experimentation. It combines the analysis of experimental models (from the process of experimental design) and functional analysis to develop more accurate and comprehensive functional specifications [5,9,10]. This tool allows designers to acquire the knowledge, specific to a field of research that is necessary and sufficient to improve their understanding of the needs of researchers. By bringing together the two main actors (researchers and designers), we avoid misunderstandings related to technological vocabulary. We optimize the exchange of scientific

and technological experiments. The practice of this tool is done according to 3 major steps (see Figure 3).

#### **3.1 Formalization of the problem**

Formalization makes it possible to validate the need for experimentation through definition of the problem, which locates it in its context of research and relatively to task objectives. At this step, we also define the limit of the phenomenon to study compared to its external environment and quantification of its goals. The main actor of this step is the researcher.

#### **3.2 Definition of the experimental model**

Our approach puts the focus on the experiment to study unlike the functional APTE method [5,10,11]. The researcher and the designer make the analysis of flow input and output but also the identification of factors. The input streams correspond to a set of factors (parameters) to vary or control. They are likely to trigger the desired phenomena. Outputs are the answers you want to know: information needed to find the solution to the study. Identification of factors to consider the phenomenon is one of the most important steps because it provides validation of the phenomenon created by the phenomenon desired and allows the evaluation of differences between the measured values and reality [12]. It analyzes the interaction between the system to consider and the elements (sources of influence). The basic elements such as humidity, temperature are taken into account but also proximity to other machines, gravity, magnetic fields, etc.

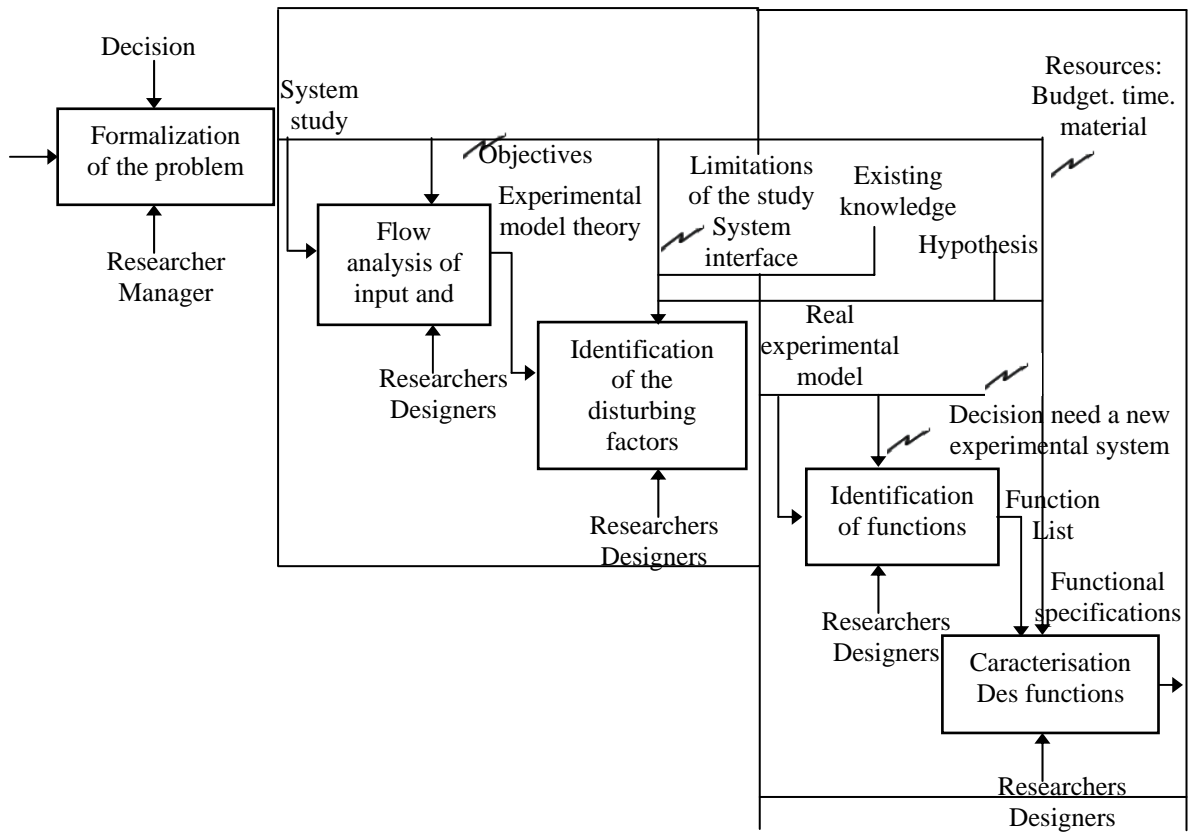

**Figure 3:** Method for functional analysis of the experimentation

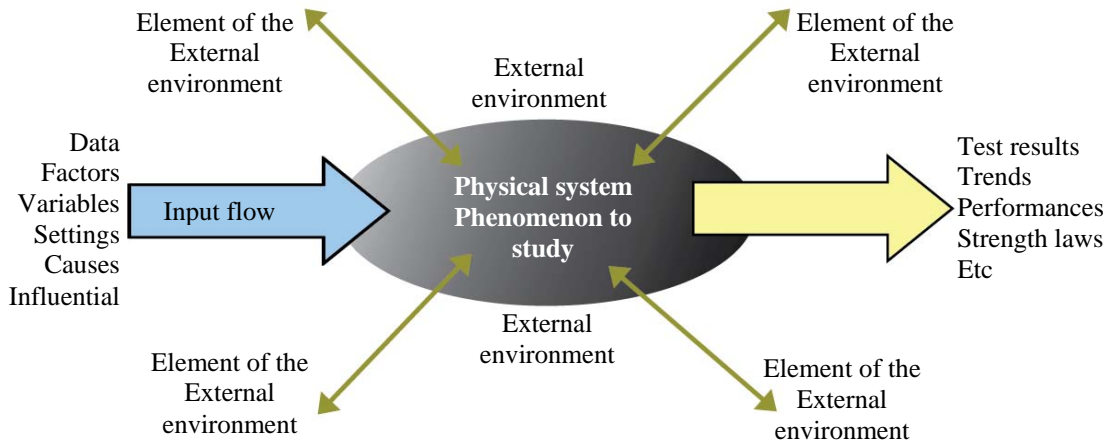

**Figure 4:** Interactions graph

### 3.3 Preparation of functional specifications

This stage declares the full state of the experimental system: the ESs is located between the study and its surroundings (see figure 4). It shows the main functions of first order, which correspond to entry and exit flows, and the main functions of second

order which correspond to interactions between experimental factors.

We can consider that SES is a filter that does pass the flow of entry and exit. All interactions must be unwanted or controlled, or evaluated, or deleted.

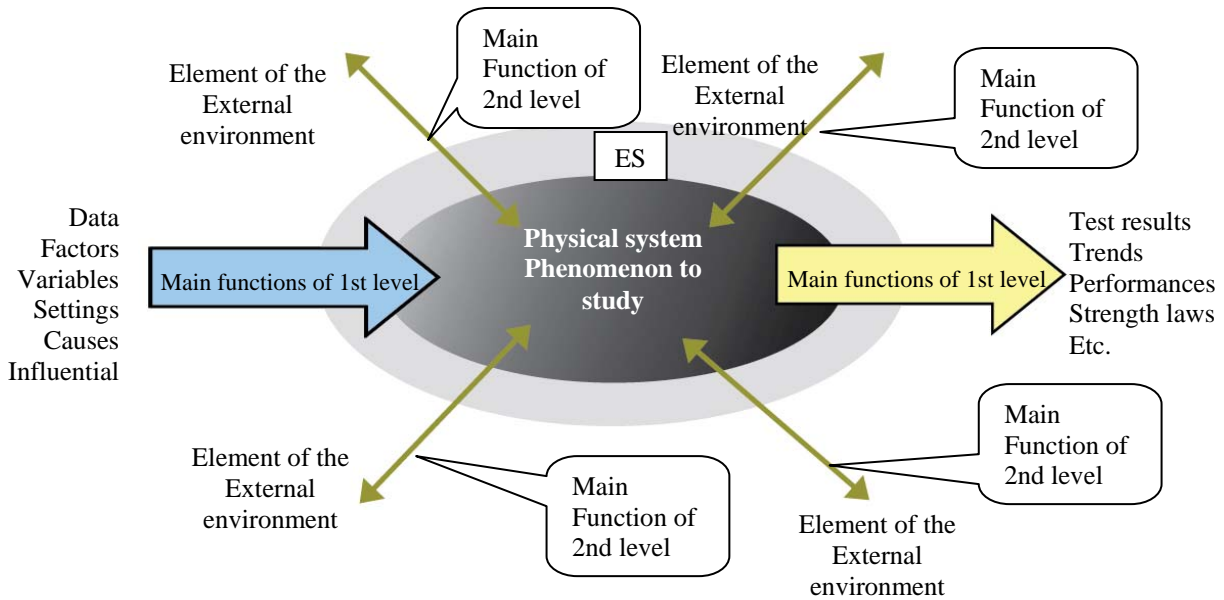
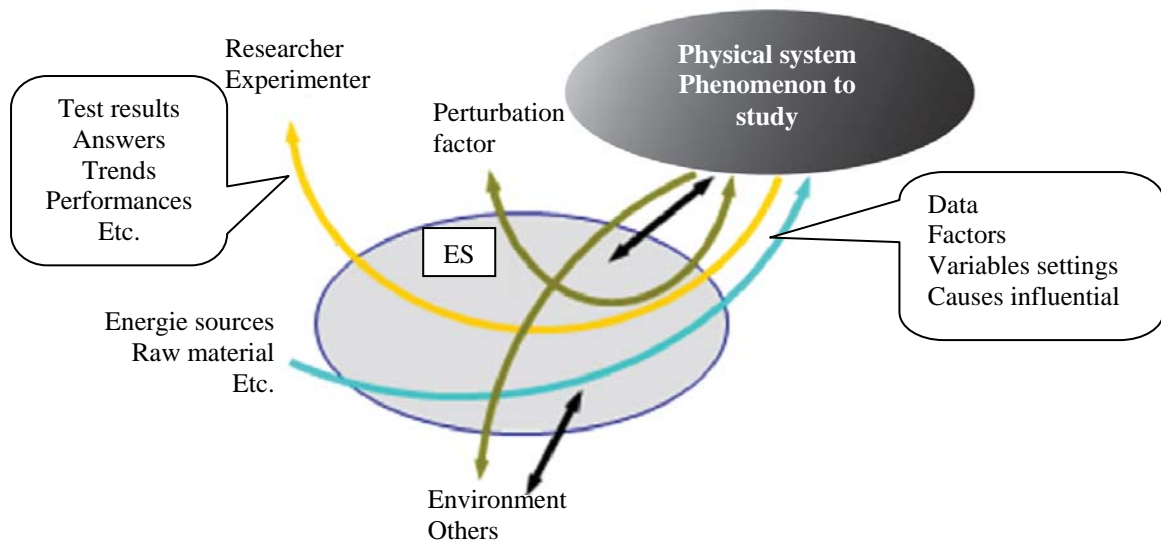

Figure 4: Functional graph

In order to identify new functions of ESs, we based our work on the practice of external functional analysis using the APTE method. To study the system and elements of the previous surroundings becomes "external environment" of ESs. All potential

interactions between the ESs and the phenomenon to study must be taken into account in the identification of constraints. This phase ends with the characterization of the functions (classification and quantification of functions).



**Figure 5:** APTE model of the system experimental

ANEXOF allows the researcher and the designer to work together on the same medium, to speak the same language. It facilitates collaborative work and comprehension (in reference to the SEMCaDeC method “Strategy of Development and Control of planning of experimental conditions” [13]).

#### 4 Application to a concrete case

In this paper, we will present a project named “dynamic Characterization and optimization of the process of joining outside plan of composite structures”. This study aims to show the effectiveness of the analysis of an experimental system using the Anexof tool. It is a complex case. Based on a protocol of standard tests (ARCAN) modified and

with an aim of developing ESs of a mixed type, this project contains typical examples of the difficulties, particularly contextual in nature, associated with the development of an ESs.

It consists in the study of an adhesive bound joint of laminated elements. The adhesives and composite materials used have well-known mechanical behaviours when they are tested separately. But the problem of adhesive bound joints comes from the local degradation of materials at the rod – composite interface. Their behaviours are then different. The purpose of the study is to characterize the dynamic behaviour of the assembly in order to simulate the shocks observed in real-world cases.

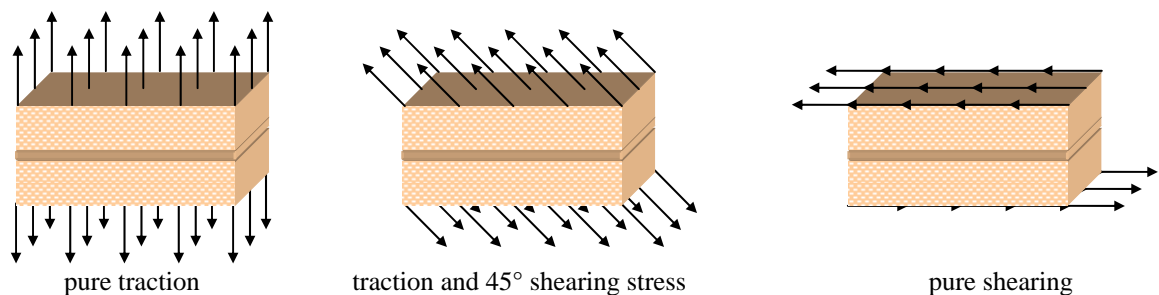

**Figure 6:** Stress modes in ARCAN trials



The phenomenon of damage to composite structures is already studied in various work [14-20]. Studies on the mechanical behavior of the structures assembled in this way are also numerous [21-26]. Thus we have some knowledge on the phenomenon which makes it possible to model the system in a state of static stress. The goal of this study is to improve this model by modelling cases of dynamic stress. The experimentation must make it possible to identify the necessary improvements in the mathematical model, before validating them. It is placed in the category of

characterization experiments. Thus the tests are quantitative and acceptable errors margins are limited.

Static tests to study the joined structures were carried out based on ARCAN tests (Figure 7), which makes it possible to apply and control transverse loads, But within the framework of the dynamic stresses, this assembly is not completely appropriate [9]. From this assembly (Figure 7), the project team would like to improve this assembly in order to exploit it for dynamic tests.

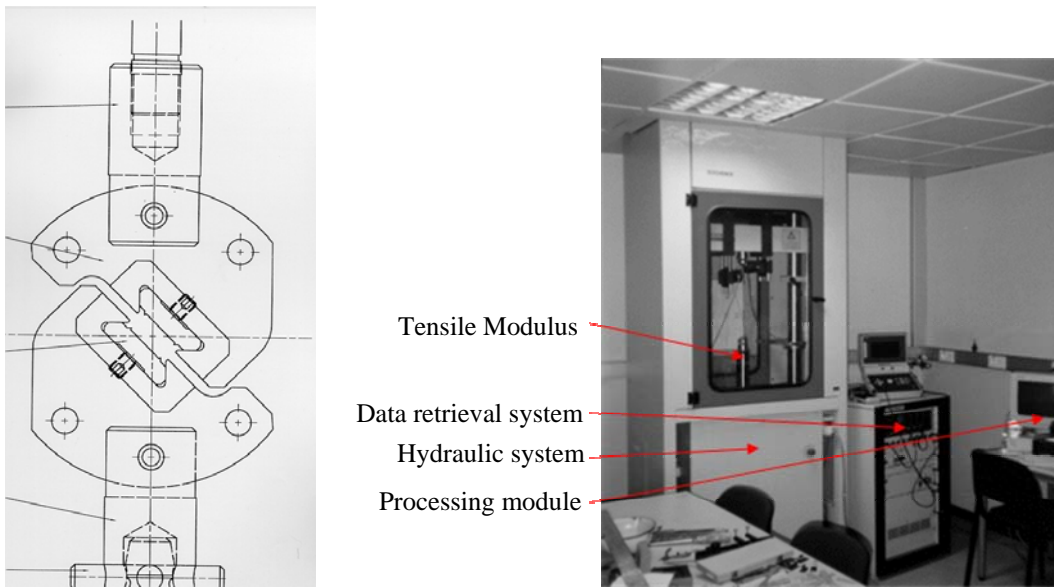

**Figure 7:** Arcan System and the high speed machine (MTGV)

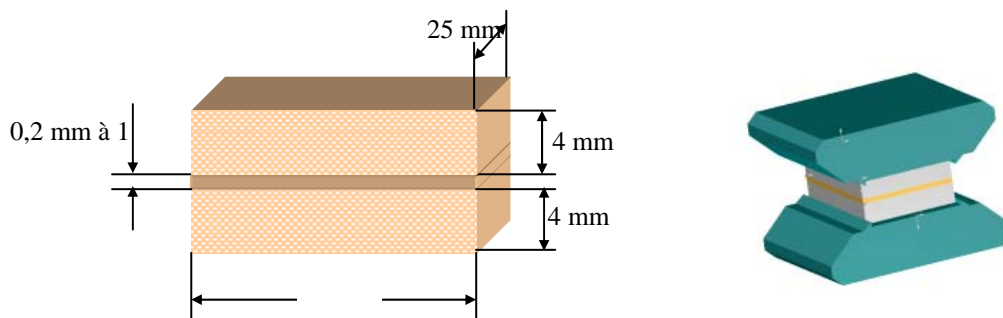

**Figure 8:** Dimensions test piece

The first finite element analyses made it possible to validate the selected dimensions [9]. All the possible interventions cross surfaces (interfaces between test-tube and the various parts of the ESs. The analysis of flows of entry and exit are represented on the figures

(below). The elements which come into contact with the system to study (test-tube) are numerous but the majority of them (e.g., gravity) do not influence the behavior very greatly.

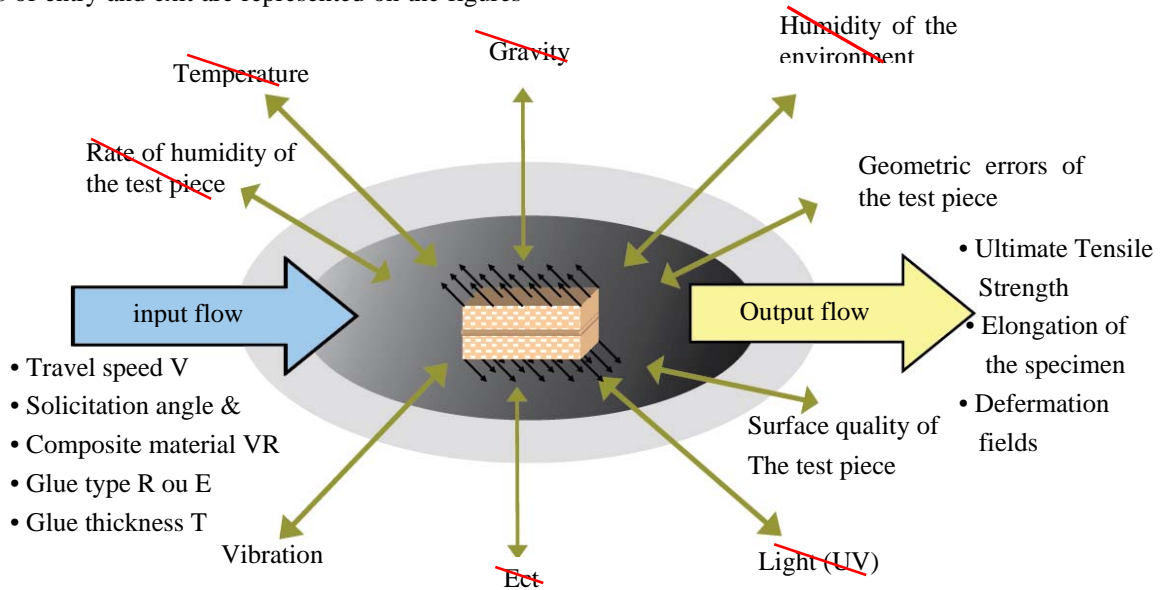

**Figure 9:** Real experimental model

Those which are likely to influence the dynamic phenomenon of rupture are very few. Most important is high frequency vibration (e.g., shocks). It supports the propagation of internal cracks and distorts test results. Concerning the parameters indicative of

interactions with the ES, we identified the parameters as geometrical and dimensional error of the test piece and their surface quality. They represent the defects of the interfaces between the system under study and the ESs.

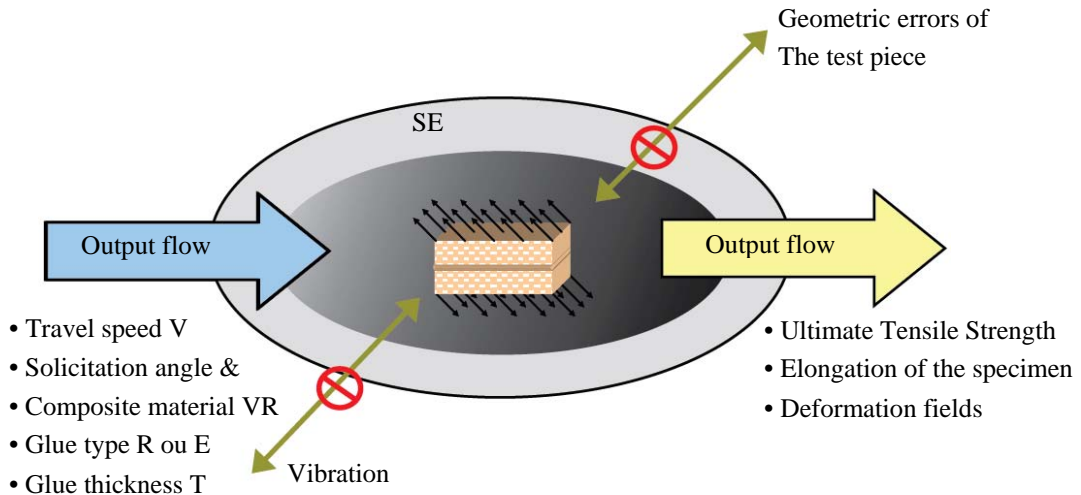

**Figure 10:** ESs positioning in the experimental model

The ESs must create the input flow, collect the output flow and avoid disruptive factors. As stated above, the ESs mixed two parts: a high speed machine (MTGV) and the part that we must develop. The

latter must make the connection between the study (test-piece) and this machine. Given the features of the MTGV, the graph of the functions of the APTE method shown in Figure 11 below:

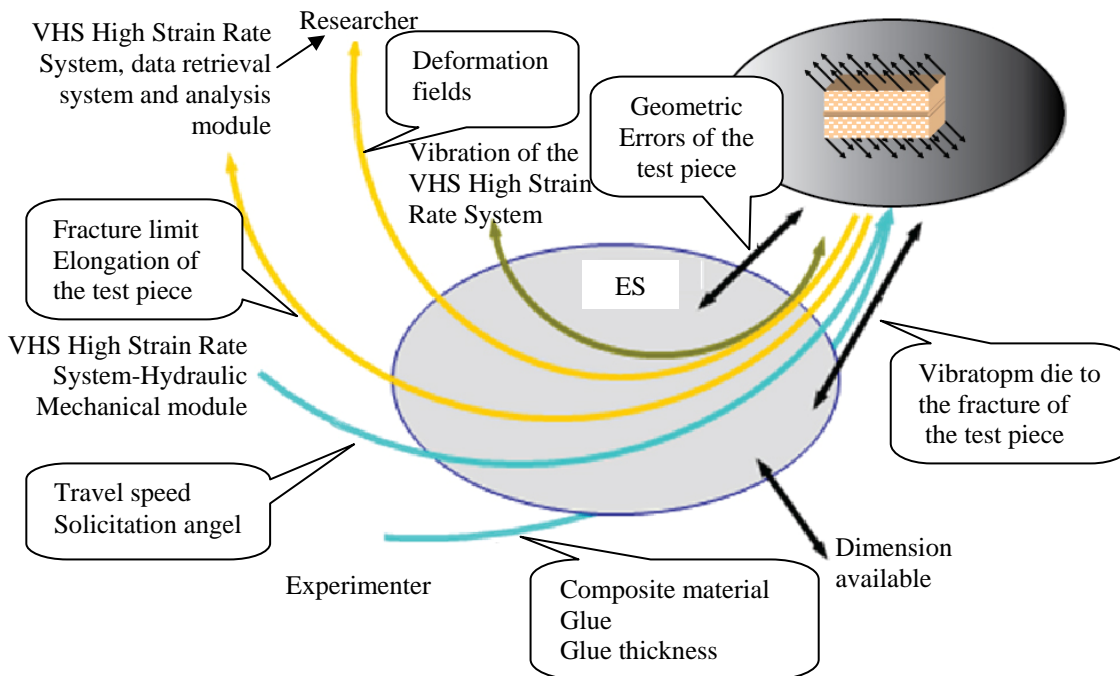

**Figure 11:** APTE model of the system experimental

The identification of the principal and secondary functions partly represented on the figure above makes it possible to draw up the summary table below:

This allows drafting specifications and provides the information needed for the construction of the test and checking the validity of results. Some examples of the information used:

- Recommendations for manufacturing test pieces (geometric errors, humidity, surface conditions, ...)
- Preparation of tests: to remove any interplay before the dynamic loading, the whole system of ESs and specimen should be placed under preload.

The study of the specifications shows that the old ARCAN system (Figure 7) cannot be improved. A design of a new ESs is necessary.

**Table1:** Overall view of the main functions of the ESs.

N°	Description	Connections	Criteria for assessment	level
<i>First-order functions.</i>				
F1	Transmit the dynamic movement	MTGV $\Rightarrow$ test-piece	Speed of movement , v stress angle $\alpha$ approximate load precision between axes	0,1 $\rightarrow$ 20m/s $\pm$ 2% 0°, 45°, 90°( $\pm$ 1°) 10 à 20 KN < 0,2mm
F2	Change the test-piece	Experimenter $\Rightarrow$ test-piece	loading time Errors in positioning	less than 30 min $\pm$ 0,2 mm
F3	Transmit real time stress delivered	test-piece $\Rightarrow$ high speed machinery stress sensor	Error in transmitted load	$\pm$ 1% of measured value
F4	Measuring the elongation of the specimen in real time	test-piece $\Rightarrow$ Zimmer device	Measurement precision	5 $\mu$ m
F5	Observe local deformation field during the trial	test-piece $\Rightarrow$ experimenters and scientists	Number of observed points Precision of observation Number of observation	EF mesh 5 $\mu$ m Minimum 4
<i>Second-order functions</i>				
F6	isolate the vibrations close to the dynamic stress	Environment $\Rightarrow$ test-piece	dynamic stress	from 1kHz to 20 kHz
F7	Avoid the influence of geometric errors of the specimen	test-piece $\Rightarrow$ stress	parallax error dimensioning error	$\pm$ 1° 0,1 mm

## 5 Conclusion

The method suggested is a mix between methods of experimental design and methods for functional analysis. It makes it possible to establish the link between the researcher with his context of research and the designer with his technological knowledge. In a more general way, it helps the designer and the researcher to exchange information using a common language. It makes it possible to formalize their association. Its use leads to a more transverse vision in the development of ESs.

The flexibility of our method makes it possible to adapt it to various levels of complexity in experimental phenomena. It showed its effectiveness in various contexts of development, of innovation,

from existing ESs to the development of new ESs. Its application is relatively simple and optimal.

The relevance of the method lies in the definition of the performance of the functions resulting from a translation of the intrinsic scientific parameters at the experiment. It should be reminded here that it is the experiment and not the product which is the focus of the analysis.

Taking into account of the interactions which allows the evolution of requirements during the process of design is a assurance of success. It makes it possible to the researcher to control the development of ME and at the same time to better know the operational limits of this one.

The applications of the step carried out within the framework of SEs to dominant mechanics, show its

relevance. Experimentation in other fields will be necessary in order to generalize its contribution. The economic dimension should be better taken into account since it will lead not only to ES "good design first" but also to cost-optimization in development. It will allow greater consistency between the budget available and the target in terms of performance. The creation of a database of external environments and interactions tailored to each area of research will be a necessary tool to facilitate the analysis. Capitalization of knowledge-based development experience ESs will provide appropriate solutions.

## References

- [1] OLF, 2009, Office Québécois de la Langue Française; Grand dictionnaire terminologique, [http://www.granddictionnaire.com/BTML/FRA/r\\_Motclef/index800\\_1.asp](http://www.granddictionnaire.com/BTML/FRA/r_Motclef/index800_1.asp)
- [2] Dortier J. F., 2000, Qu'est ce qu'un chercheur, Journal Histoire et Philosophie des sciences, Hors série N° 31.
- [3] Bernard C., 1966, Introduction à la médecine expérimentale, réédition, Edition Garnier-Flammarion, Paris.
- [4] Jacques G., 2001 Introduction aux plans d'expériences, 2èmes édition, DUNOD.
- [5] Françaises N., - Analyse de la valeur, Analyse Fonctionnelle ; NF X 50-151 ; NF X 50-152 ; NF X 50-153, <http://www.afav.eu/>
- [6] Tagushi G. and Phadke M. S., 1984, Quality Engineering through Design Optimisation, in Global Telecommunications Conference Edition IEEE, Atlanta, GA.
- [7] Osborne D. M. and Armacost R. L., 1996, Review of techniques for optimizing multiple quality characteristics in product development, Computers in engineering, 31(1-2):107-110.
- [8] Luong L., 2001, Enquête sur l'état de développement et d'utilisation de Systèmes d'expérimentations; Rapport de l'enquête.
- [9] Luong L., 2005, Thèse de doctorat, Conception des moyens d'expérimentation, approche de cohérence en coût-performance, septembre 2005.
- [10] Delafollie G. and Texido C., 1998, Les outils d'analyses initiales de conception; Conception en mécanique industrielle ; Edition Les Référentielle Dunod ; Chapitre 3.9.
- [11] Bretesche B., 2000, La méthode APTE, Analyse de la valeur, analyse fonctionnelle, Editions Petrelle.
- [12] Tagushi G., Chowdhury S. and Tagushi S., 2000, Robust Engineering, American Supplier Institute, McGraw-Hill.
- [13] Martin P., Lossent L., Abt L. and Brassat F., 2004, Conception de machines spéciales : méthodologie d'élaboration de cahier des charges, Journal de Mécanique & Industries, 5(3):305-316.
- [14] Arcan M., Hashin Z. and Voloshin A., 1978, A Method to Produce Uniform Plane Stress States with Applications to Fiber-Reinforced Materials, Experimental mechanics, 18(2):141-146.
- [15] Arcan L., Arcan M. and Daniel I., 1987, SEM Fractography of Pure and Mixed Mode Interlaminar Fracture in Graphite/Epoxy Composites, ASTM Special Technical Publication, 948 :41-67.
- [16] Gineste B., 1993, Assemblage de structures en matériaux composites par stratification d'un élément de liaison, caractérisation de l'endommagement, Thèse de doctorat de l'Ecole Centrale de Nantes.
- [17] Hung S. C. and Leichti K. M., 1997, An Evaluation of the ARCAN Specimen for Determining the Shear Moduli of Fiber-Reinforced Composites, Experimental mechanics, 37(4):460-468.
- [18] Hung S. C. and Leichti K. M., 1999, Finite Element Analysis of the ARCAN Specimen for Fiber-Reinforced Composites under Pure Shear and Biaxial Loading, Journal of composites materials, 33(14):1288-1317.
- [19] Rozycki P., 2000, Contribution au développement des lois de comportement pour matériaux composites soumis à l'impact, Thèse de doctorat de l'Université de Valenciennes et du Hainaut Cambrésis.
- [20] Dormegnien D., 2001, Contribution à l'étude de loi de similitude applicables au crash de structures composites stratifiés du type absorbeur d'énergie, Thèse de doctorat à l'Université de Valenciennes et du Hainaut Cambrésis.
- [21] Fischer M. and Pasquier M., 1989, Shear Behaviour of Structural Adhesives in the

- Bondline, *Construction & Building Materials*, 3:31-34.
- [22] Adams R. D., Comyn J. and Wake W. C., 1997, *Structural Adhesives Joints in Engineering*, 2nd edition, Chapman & Hall.
- [23] Neon N., 1998, *Mécanismes de rupture de l'interface implant ciment des tiges fémorales*, thèse de l'université de Nantes.
- [24] Tong L. and Steven G. P., 1999, *Analysis and Design of Structural Bonded Joints*, Boston: Kluwer Academic.
- [25] Penado F. E. 2000, *Analysis of Singular Regions in Bonded Joints*, *International Journal of Fracture*, 105:1-25.
- [26] Cheikh M., Coorevits P. and Loredo A., 2001, *Modelling the Stress Vector Continuity at the Interface of Bonded Joints*, *International Journal of Adhesion & Adhesives*, 22:249-257.