



## Science Arts & Métiers (SAM)

is an open access repository that collects the work of Arts et Métiers Institute of Technology researchers and makes it freely available over the web where possible.

This is an author-deposited version published in: <https://sam.ensam.eu>  
Handle ID: <http://hdl.handle.net/10985/25866>



This document is available under CC BY license

### To cite this version :

Koffi Samuel KOULEKPA, Chadi BENKED-DAR, Hélène L. ELIAS-BIREMBAUX, FREDERIC ROSSI, Gerard POULACHON - Investigating the efficiency of mixtures based on supercritical CO<sub>2</sub> and lubricants by friction tests under conditions similar to the machining of Ti6Al4V - Frontiers in Manufacturing Technology - Vol. 4, p.01-08 - 2024

Any correspondence concerning this service should be sent to the repository

Administrator : [scienceouverte@ensam.eu](mailto:scienceouverte@ensam.eu)





## OPEN ACCESS

## EDITED BY

Vincent Wagner,  
École Nationale d'Ingénieurs de Tarbes, France

## REVIEWED BY

Tom Slatter,  
Loughborough University, United Kingdom  
Munish Gupta,  
Shandong University, China

## \*CORRESPONDENCE

Koffi Samuel Koulekpa,  
✉ koffi.koulekpa@ensam.eu

RECEIVED 31 March 2024

ACCEPTED 30 September 2024

PUBLISHED 31 October 2024

## CITATION

Koulekpa KS, Benked-Dar C, Elias-Birembaux H, Rossi F and Poulachon G (2024) Investigating the efficiency of mixtures based on supercritical CO<sub>2</sub> and lubricants by friction tests under conditions similar to the machining of Ti6Al4V. *Front. Manuf. Technol.* 4:1410292. doi: 10.3389/fmtec.2024.1410292

## COPYRIGHT

© 2024 Koulekpa, Benked-Dar, Elias-Birembaux, Rossi and Poulachon. This is an open-access article distributed under the terms of the [Creative Commons Attribution License \(CC BY\)](#). The use, distribution or reproduction in other forums is permitted, provided the original author(s) and the copyright owner(s) are credited and that the original publication in this journal is cited, in accordance with accepted academic practice. No use, distribution or reproduction is permitted which does not comply with these terms.

# Investigating the efficiency of mixtures based on supercritical CO<sub>2</sub> and lubricants by friction tests under conditions similar to the machining of Ti6Al4V

Koffi Samuel Koulekpa\*, Chadi Benked-Dar, Hélène Elias-Birembaux, Frédéric Rossi and Gérard Poulachon

Arts et Métiers Institute of Technology, LaBoMaP, Université Bourgogne Franche-Comté, Cluny, France

New supercritical carbon dioxide (scCO<sub>2</sub>)-based cutting fluids combining the cooling from scCO<sub>2</sub> and lubrication from various additives are investigated in this study. Selected components, including ionic liquids, vegetable and mineral oils, water, and PEG, were introduced into supercritical CO<sub>2</sub>, and tribological tests were performed on a CNC lathe to analyze their influence on Ti6Al4V/WC-Co contact. Forces and temperatures were recorded to compare the performances of the scCO<sub>2</sub>-lubricant mixtures for future use in machining. The analysis of the apparent friction coefficient and sticking zone showed a noticeable decrease by ionic liquids when combined with scCO<sub>2</sub> at a speed of 100 m/min and 4 mL/min delivery flow rate. The other lubricants (water and PEG vegetable oils) performed similarly to standard mineral oil and are less expensive, which could help in developing future low-cost yet effective cooling and lubrication methods for the machining industry.

## KEYWORDS

tribology, cryogenic cutting, supercritical CO<sub>2</sub>, ionic liquids, minimum quantity lubrication

## 1 Introduction

New cooling and lubrication methods for machining processes are under investigation to improve tool life and the quality of machined parts. These methods aim to reduce both friction and heating phenomena at chip/tool and tool/part contact zones. The application of supercritical CO<sub>2</sub> (scCO<sub>2</sub>)-based cutting fluids as replacement of previous methods (flood coolants, minimum quantity lubrication, or cryogenics such as liquid nitrogen) has proved to be of great interest for the machining industry. Carbon dioxide becomes supercritical at conditions above 31°C and 74 bar (McHugh and Krukonis, 1994). When delivered to the cutting zone, the expansion due to phase transformation leads to a temperature decrease, enabling a cooling effect on both the cutting tool and the machined part (Cai et al., 2021). In addition, scCO<sub>2</sub> is known as a green solvent (Hyatt, 2002), so different lubricants could be added to combine cooling and lubrication effects, making this technique worth exploring.

As an example, Supekar et al. (2012) used soybean oil dissolved in scCO<sub>2</sub> (0.001 g/s) when milling compacted graphite iron at 150 m/min. The flank wear measured after 250 s was roughly half of that measured using emulsion flood. Different studies recorded lower tool wear with scCO<sub>2</sub> + MQL compared to the flood coolant: Tapoglou et al. (2021) in

TABLE 1 List of lubricants and tested conditions.

Mixture	Cooling fluid	Lubricant	Flow rate	Force $F_N$ (N)	Speed (m/min)
scCO <sub>2</sub>	scCO <sub>2</sub>	None	scCO <sub>2</sub> : 0.185 kg/min Lubricant: 1 mL/min and 4 mL/min	100	20
scCO <sub>2</sub> + W		Water		250	
scCO <sub>2</sub> + MQL		Mineral oil		400	
scCO <sub>2</sub> + R		Rapeseed oil			
scCO <sub>2</sub> + S		Sunflower oil			
scCO <sub>2</sub> + PE		PEG			
scCO <sub>2</sub> + PF6		BMIM-PF6			
scCO <sub>2</sub> + BF4		BMIM-BF4			
Dry	None	None	-		

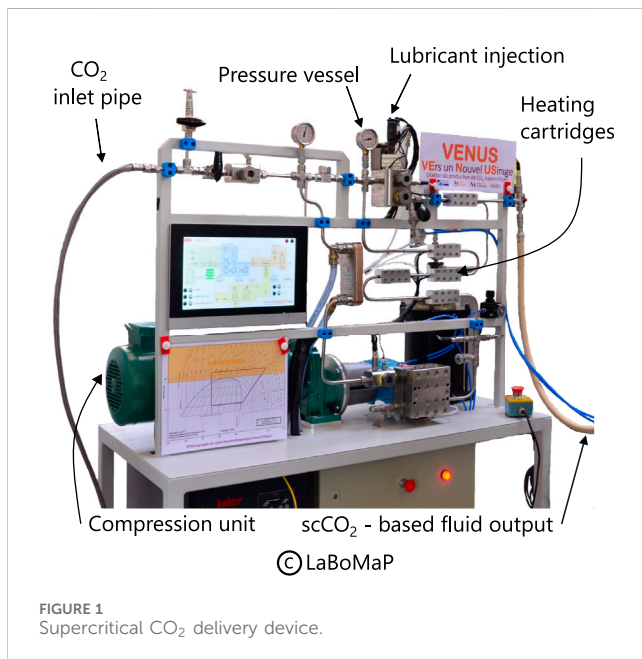

FIGURE 1  
Supercritical CO<sub>2</sub> delivery device.

milling Ti6Al4V and [Rahim et al. \(2016\)](#) on turning AISI 1045 steel. The global trend demonstrated longer tool life with scCO<sub>2</sub> + MQL while scCO<sub>2</sub> alone often performed worse than the flood coolant ([Tapoglou et al., 2021](#)). Other studies added oil-on-water (OoW) to scCO<sub>2</sub> + MQL, which resulted in reducing both tool wear and cutting temperatures, better than scCO<sub>2</sub> + MQL in milling operations for 316L stainless steel ([Yuan et al., 2018](#)), Si<sub>p</sub>/Al composite ([Yu et al., 2022](#)), Inconel 718 ([Zhang et al., 2021](#)), and Ti6Al4V ([Cai et al., 2021](#)).

These studies showed that scCO<sub>2</sub> combined with soluble lubricants is an interesting way to reduce friction in machining processes. Investigating the lubrication potential of other components in scCO<sub>2</sub> (preferably sustainability-oriented or low-cost) is a topic to be explored.

This work aims to investigate the influence of scCO<sub>2</sub> associated with different lubricants on the friction by using tribological tests, as performed for other cooling techniques [[Courbon et al. \(2020\)](#) for liquid nitrogen; [Pušavec et al. \(2020\)](#) for liquid carbon dioxide]. As

these cooling techniques are especially useful in the case of difficult-to-cut material, Ti6Al4V is considered in this study. It is a well-known material widely applied in the aerospace industry, and several studies have previously investigated the improvements using cryogenic cooling on the cutting of Ti6Al4V, especially liquid CO<sub>2</sub> ([Bergs et al., 2019](#); [Gross et al., 2019](#)).

Several components are selected to be paired with scCO<sub>2</sub>, based on either their solubility in scCO<sub>2</sub>, their sustainable character, or their previous performances in machining-related friction analysis. The evaluation of the apparent friction coefficient could help develop future efficient scCO<sub>2</sub>-based cutting fluids and could be useful for scCO<sub>2</sub>-assisted finite element method (FEM) simulations.

## 2 Lubricant selection

Different types of components have been chosen based on previously numbered reasons. The components are described below and summarized in [Table 1](#).

### 2.1 Ionic liquids

First, ionic liquids (ILs) have been reported by [Sahab et al. \(2017\)](#) to improve lubrication in reducing wear scar diameter (13%) during a tribological four-ball wear test. [Davis et al. \(2015\)](#) also noticed a better decrease of cutting forces when comparing IL-based MQL to water-based MQL during titanium machining. Their attractive properties, such as low melting point, negligible volatility, high thermal stability, and non-flammability, make them interesting lubricants for machining applications. Ionic liquids are soluble in scCO<sub>2</sub> with a solubility that increases with pressure ([Wu et al., 2003](#)). Two ILs that have already been used in machining cutting fluids ([Davis et al., 2015](#)) are retained to be tested with scCO<sub>2</sub> in the present study, namely, 1-butyl-3-methylimidazolium hexafluorophosphate (BMIM-PF6) and 1-butyl-3-methylimidazolium tetrafluoroborate (BMIM-BF4). These components are from BLDPharm with molecular weights of 248.18 g/mol and 226.02 g/mol, respectively.

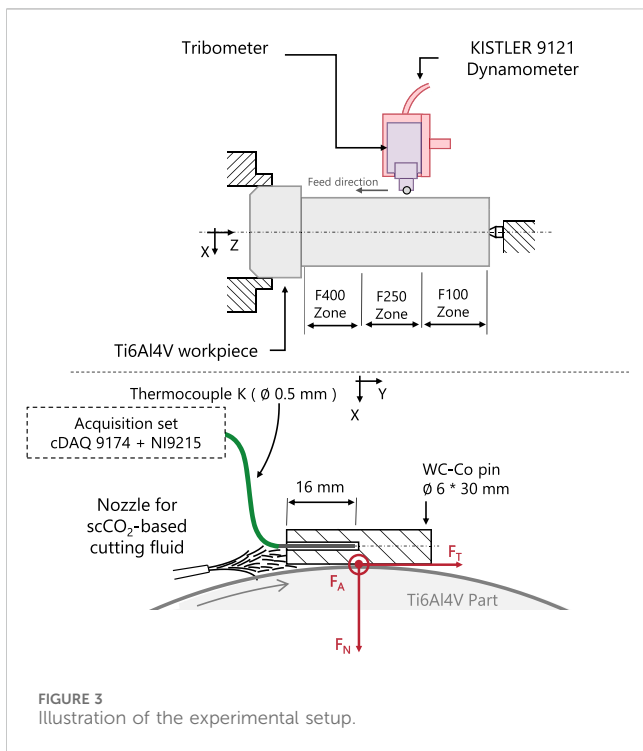
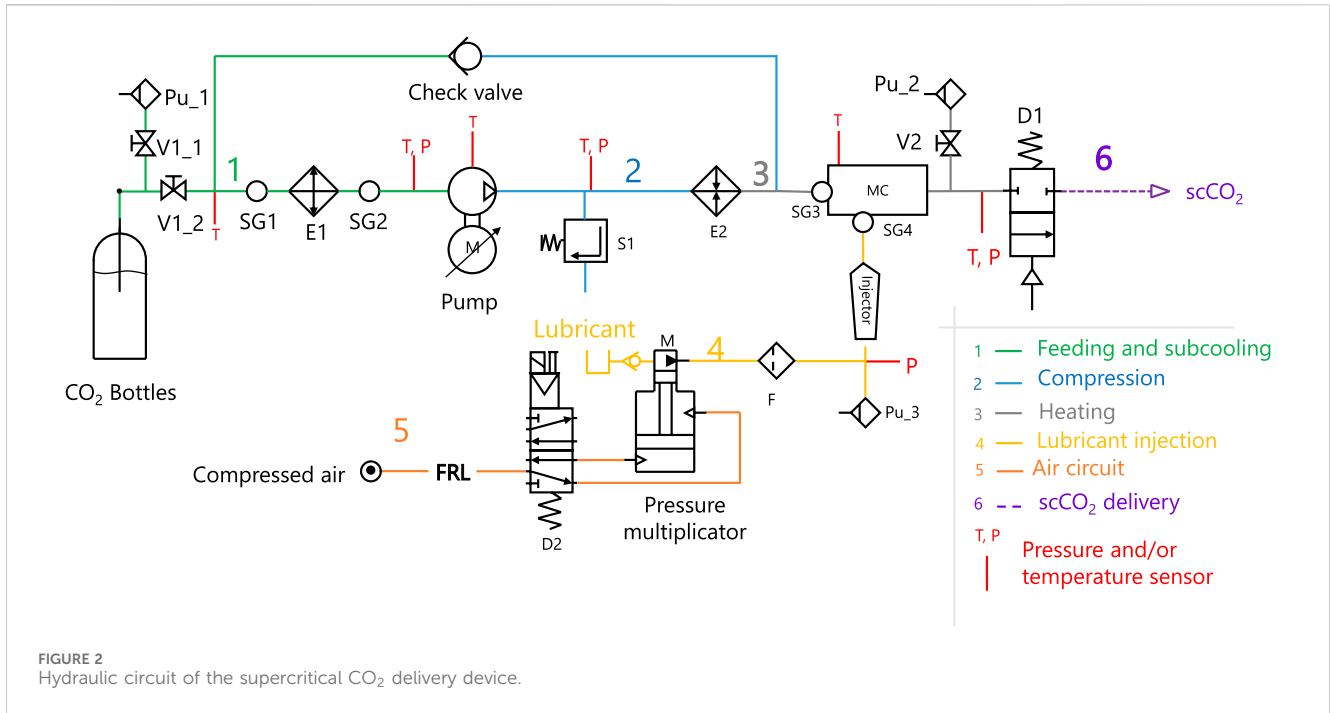

## 2.2 Vegetable oils

Another leverage of sustainability in machining assistance techniques is the use of vegetable-based oils. Commercial sunflower (S) and rapeseed (R) oils have been chosen because they are available, soluble in scCO<sub>2</sub>, and have a high potential in cryogenic minimum quantity, as demonstrated by Meier et al. (2021) in milling tests.

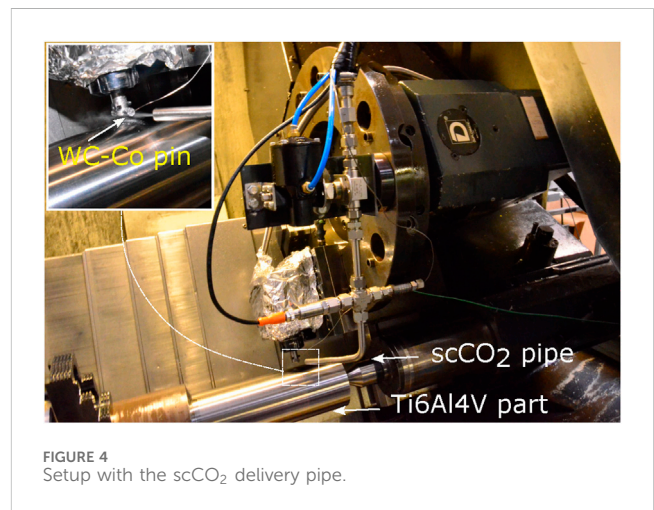

## 2.3 Other lubricants

Polyethylene glycol (PEG) from ThermoFisher (molecular weight: 200 g/mol) is also tested in this study. As reported by Goindi et al. (2018), it can be used as a lubricant although it is expected to decrease tool wear less than ionic liquids. The influence of dissolved droplets of water in scCO<sub>2</sub> on the apparent coefficient friction has also been selected for investigation because of its cooling ability shown in milling and grinding (Cai et al., 2021; Dang et al., 2021). A common mineral oil with a kinematic viscosity at 40°C of 28 mm<sup>2</sup>/s, named here MQL, has been chosen for comparison with the selected previous lubricants when associated with scCO<sub>2</sub>.

The lubricants selected in this study offer greater availability and are less health-threatening than traditional emulsions due to their

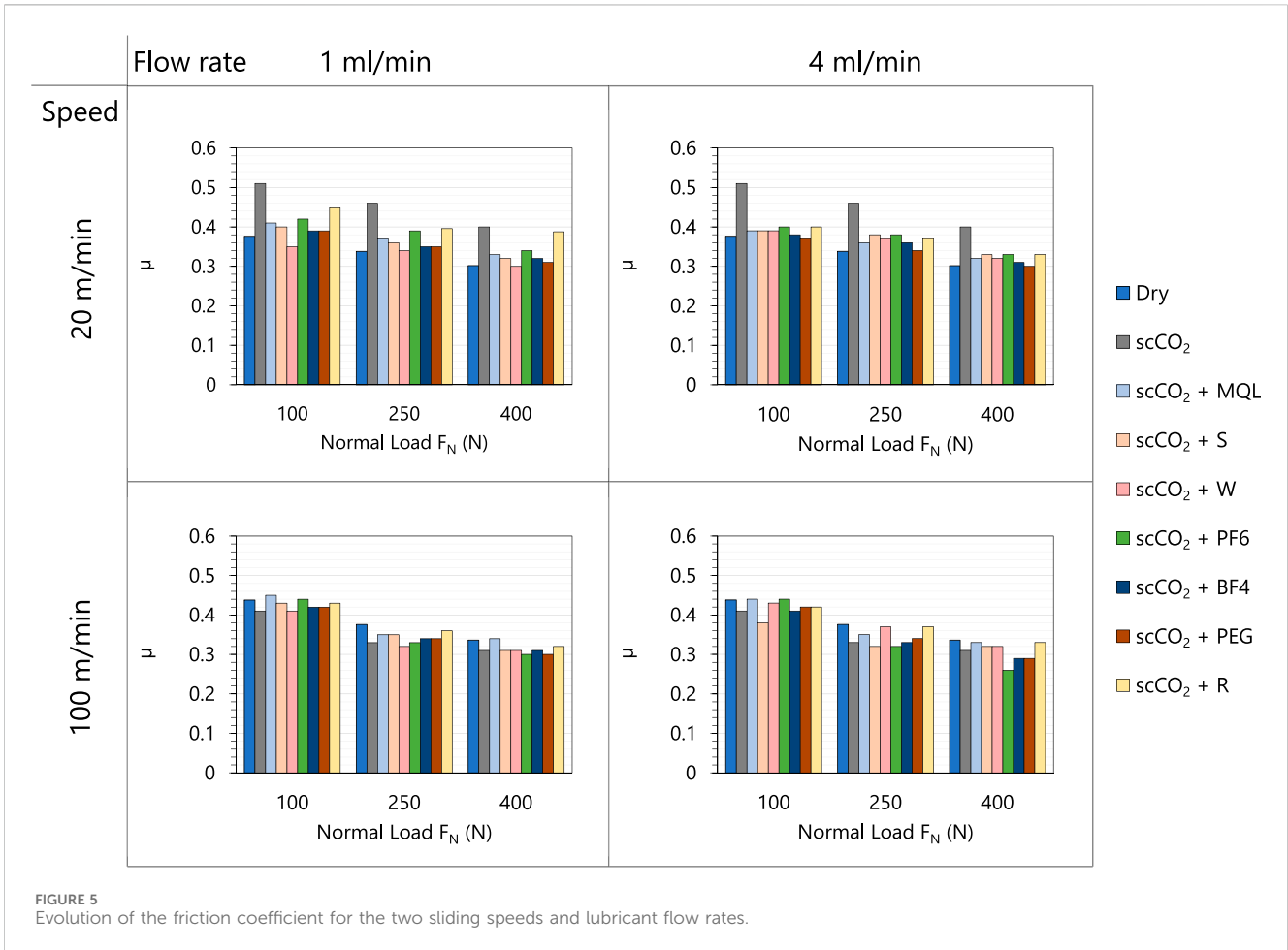

FIGURE 5 Evolution of the friction coefficient for the two sliding speeds and lubricant flow rates.

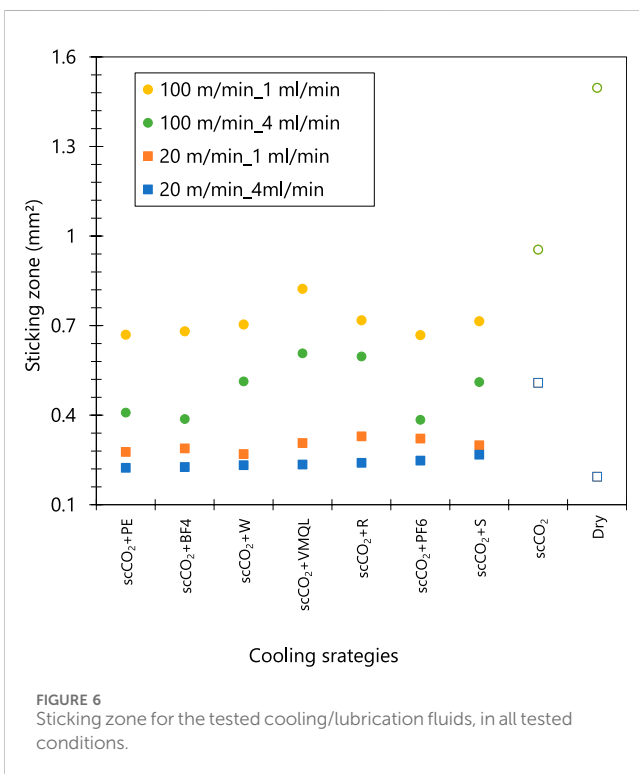

FIGURE 6 Sticking zone for the tested cooling/lubrication fluids, in all tested conditions.

biological composition. *Pereira et al. (2016)* have already highlighted the sustainability of cryo-MQL cooling methods over conventional flood coolants, considering environmental factors such as toxicity, power consumption, and ozone depletion.

However, the chosen lubricants here would not be suitable for machining applications where cleanliness is crucial, such as in the biomedical and agri-food industries.

### 3 Experimental setup and methods

#### 3.1 scCO<sub>2</sub>-based mixture delivery machine

A research-dedicated setup (*Figure 1*) was designed and manufactured to produce scCO<sub>2</sub>-based cutting fluids. The hydraulic circuit is illustrated in *Figure 2*. The different parts of the process are presented in a dedicated video available online at <https://cutt.ly/yw9oGrxP>.

The machine is fed in CO<sub>2</sub> from a rack of bottles stored at ambient temperature and a pressure of 60 bar, where the CO<sub>2</sub> might be liquid or gas. To ensure a liquid phase before compression, the entering liquid/gas CO<sub>2</sub> is cooled to 10° through a heat plate exchanger E1 before compression and heating to desired values of pressure (P) and temperature (T). Real-time measurements of (P) and (T) are monitored by a

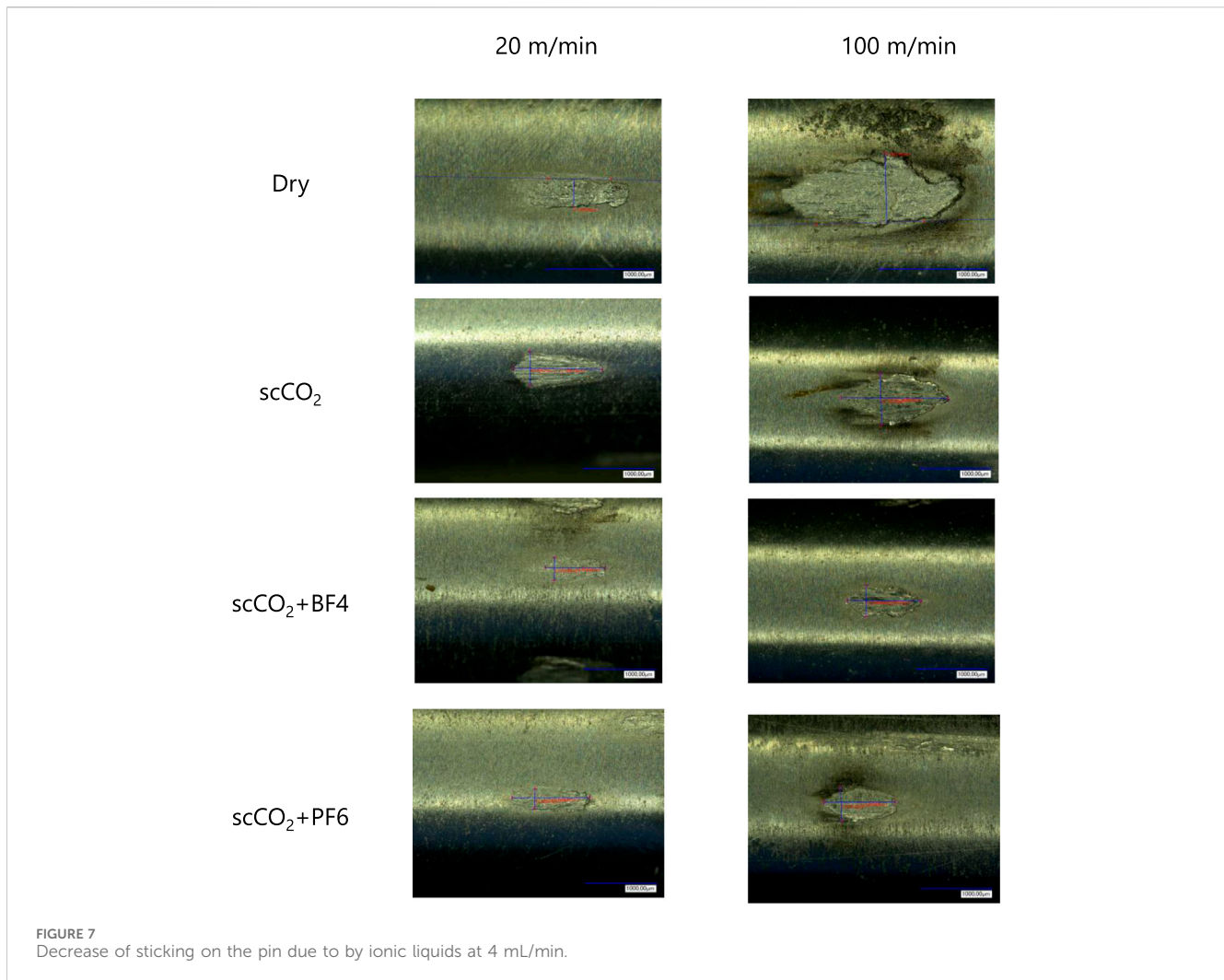

controller to fit to the user-specified commands. The liquid CO<sub>2</sub> is then compressed to the desired pressure (maximum of 350 bar). The temperature is then increased by four heating cartridges E2 to reach the supercritical state in the mixing chamber (MC), where lubricants are delivered at a user-specified injection rate. The scCO<sub>2</sub> with or without lubricants is then delivered through a round jet nozzle by activating the pneumatic valve D1. Several sight glasses are positioned along the circuit to visualize the state of the fluid (SG1 to SG4), the occurring phase transformation, and the lubricant injection (SG3 and SG4).

A nozzle diameter of 0.25 mm was used for this study. The flow rate of scCO<sub>2</sub> was 0.185 kg/min, determined by bottle mass difference measurement. The lubricants were delivered at 1 mL/min and 4 mL/min, which are common delivery rates for MQL applications.

The pressure was limited to 100 bar, and the temperature was set to 40°C. This choice was made to guarantee a supercritical state and sufficient flow rate while minimizing CO<sub>2</sub> consumption with limited pressure. Additionally, being slightly above the critical temperature helps avoid the reduced mass flow rate that typically occurs during scCO<sub>2</sub> expansion at higher temperatures (Fan et al., 2018).

### 3.2 Tribology: setup and conditions

A pin-on-cylinder tribometer was used to reproduce the pressure at the chip/tool contact and chip sliding velocities. As illustrated in Figure 3, the tribometer screwed on a dynamometer (KISTLER 9121) was mounted on a SOMAB T500 lathe for the friction tests. A Hedenqvist-type tribometer (cylindrical pin on a cylindrical bar) was chosen for easy and quick execution (Hedenqvist and Olsson, 1991). The normal load  $F_N$  was applied by controlled displacements, determined in a preliminary test. After each friction test, the workpiece's surface was refreshed by a VBMT 160408 MT insert mounted on the SVVBN 2525 M16 tool holder at  $f = 0.11$  mm/rev to obtain a theoretical surface roughness of  $R_a \approx 0.5$  µm.

The  $\phi 6 \times 30$  mm cylindrical carbide pins were instrumented with a K thermocouple of  $\phi 0.5$  mm diameter connected to a cDAQ9174 + NI9215 acquisition set for temperature measurement during the test at a 2 kHz rate, as illustrated in Figure 3. A Ti6Al4V workpiece with an initial diameter of 120 mm was used for the experiment (Figure 4). After each test, the pins are rotated by 25° to use a new contact surface or changed if completely worn. The newly machined workpiece surface was cleaned to remove the residuals of previous lubricants.

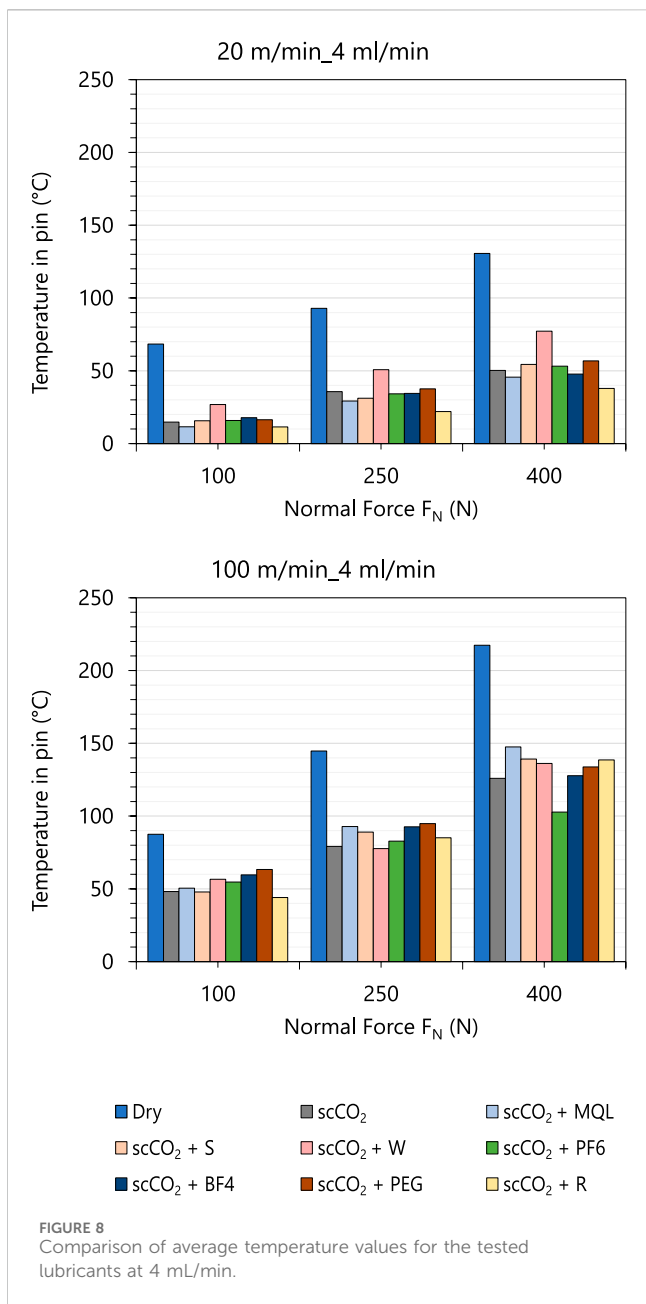

Only two sliding velocities of 20 m/min and 100 m/min (rotation of Ti6Al4V bar), based on a previous study by Courbon et al. (2020) on Ti6Al4V, were retained to reduce the number of experiments. These values cover the range of chip sliding velocities in machining difficult-to-cut alloys such as Ti6Al4V or Inconel718 (Courbon et al., 2013). Remember here that the main purpose is to investigate the comparative performance of the chosen mixtures (scCO<sub>2</sub> + lubricants) rather than typical tribological analysis with variable sliding speeds. The pin was moved at three different speeds (0.5, 0.75, and 1 mm/rev) corresponding to each force zone in Figure 3.

For the normal load, a contact pressure of 1,300 MPa based on the experimental results of Outeiro et al. (2015) was used as the benchmark for a mechanical indentation FEM simulation to find corresponding tribological forces to use in the experiments, in

association with chosen sliding velocities. Three values of forces, 100 N, 250 N, and 400 N, were selected and are presented in Table 1.

The recorded normal  $F_N$  and tangential forces  $F_T$  were used to calculate the apparent friction coefficient  $\mu$  by Equation 1.

$$\mu = \frac{F_T}{F_N} \tag{1}$$

## 4 Results and discussions

### 4.1 Influence of lubricants on apparent friction coefficient

All measured forces remained constant throughout each test (above 60 s), as well as the temperature, apart from the quick transition increase at the beginning of the friction. The average values of the apparent friction coefficient are computed for all the tested lubrication methods and compared in Figure 5.

The values for the apparent coefficient of friction reported here for dry tests at 100 m/min are higher than those obtained in tests with a spherical tip carbide (Courbon et al., 2020). For similar studies using the pin-on-cylinder tribological test at a 500 N load, the 0.25 value obtained by Courbon et al. (2020) is lower than those observed here with similar conditions of 400 N and 100 m/min. This could be due to our lower load conditions and the influence of the cylinder-on-cylinder contact (which has a larger surface area than spherical-tip-on-cylinder contact), potentially reducing the applied loads. As Courbon et al. (2020) cited from Meier et al. (2017), the friction coefficient is higher at lower loads. We assume these reasons could explain the differences between our results and their findings. Nevertheless, they reported no influence of the sliding speed on the coefficient of friction.

The main idea here is rather to check whether the selected lubricants can improve the contact when paired with scCO<sub>2</sub>. As suspected, scCO<sub>2</sub> alone had almost no lubrication effect. Existing friction tests with liquid CO<sub>2</sub> (Pušavec et al., 2020) or machining tests with scCO<sub>2</sub> (Tapoglou et al., 2021), without lubricant studies showed only the cooling effect of the CO<sub>2</sub> coolants. This study hence demonstrates the need for lubrication when using supercritical CO<sub>2</sub> in friction-related applications.

For the 20 m/min sliding tests, even if the addition of lubricants to scCO<sub>2</sub> decreased the friction, the scCO<sub>2</sub>-based fluids did not perform better than the dry test, as expected. The value of  $\mu$  for the scCO<sub>2</sub>-based fluids stayed above the one for dry test for almost all loads.

Nevertheless, a mean decrease of 0.1 in the apparent friction coefficient value was observed for the tests at 100 m/min. When increasing the lubricant flow rate from 1 mL/min to 4 mL/min, reductions of  $\mu$  values occurred at 100 m/min. The lubricating effect of the used ionic liquids (PF6 and BF4), cited from previous literature (Section 2), could be depicted for the 100 m/min conditions with significant friction decreases at 4 m/min and 400 N. Even if it is well known that lower friction at higher speed could be due to material softening (Rech et al., 2013), the decrease of  $\mu$  observed here could be associated with the combined effect of lubrication by the additives and cooling from scCO<sub>2</sub> because of the notable differences between the values of  $\mu$  for

scCO<sub>2</sub> + IL and scCO<sub>2</sub> alone. Except for the ionic liquids, the effects of the additives were not clearly visible here.

It is also important to notice that “cheap” lubricants, such as water or rapeseed oils, were similar to commonly used machining mineral oil (MQL) when paired with scCO<sub>2</sub>, which might be interesting for sustainability consideration or cost reduction. Solubility tests of these additives in scCO<sub>2</sub> under the tested conditions will be investigated for more insight.

## 4.2 Influence of lubricants on sticking

Ti6Al4V is known for adhesive behavior on the countermaterial in friction tests. The friction zone is then observed under an optical microscope after each test (meaning the application of all loads for the considered cooling conditions) to relate the area of sticking on the pin to the evolution of the apparent coefficient through all tests. Hedenqvist and Olsson (1991) used image post-processing to obtain the sticking area. Here, the observed zone is assimilated to an ellipse, and its area is calculated from the two measured half-axis. Though this method is less accurate than the one from Hedenqvist and Olsson (1991), it allows a comparison of the influence of the lubricating strategies on the sticking zone. This is summarized in Figure 6.

As seen for the apparent friction coefficient, no gain regarding friction was recorded at 20 m/min by adding the lubricants in scCO<sub>2</sub>, with respect to the dry condition. However, their effects are clearly visible at 100 m/min. The lubricating effect of the ionic liquids is confirmed here as they led (together with PEG) to the lowest sticking area values. At 1 mL/min rate, the surface is reduced by 54% and 55% for BF<sub>4</sub> and PF<sub>6</sub>, respectively. These values increased to 74% at 4 mL/min, showing the influence of the flow rate on the sticking.

Examples of sticking patterns are presented in Figure 7 to show the effect of the ionic liquids paired with scCO<sub>2</sub> under the 4 mL/min conditions. The formation of a sticking area is well known for the Ti6Al4V/WC-Co friction tests due to severe plastic deformation occurring at the pressures applied. In addition, high sliding speeds lead to material softening because of local temperatures, thereby increasing the sticking area. This explains the differences in sticking between the 20 m/min and the 100 m/min conditions. Adding lubricants, such as mineral or vegetable oils, forms an adsorption layer that reduces the contact between the two materials, as reported by Meier et al. (2017) or Sahab et al. (2017), explaining the decrease observed between the dry condition and the mixtures applied. It is important to note that the vegetable oils performed similarly and slightly better than the scCO<sub>2</sub> + MQL. Similar phenomena are occurring here (tribofilms) but with more effectiveness with vegetable oils, which are more available. Especially for the ionic liquids, Davis et al. (2015) noticed a very low titanium deposition on the cutting edge when using these ILs in milling, demonstrating the effectiveness of the protective layer formed by the presence of the additives. They attributed this to the tribochemical reaction between the ILs and the tool/workpiece material based on analyses of tribological performances and surface tensions made on the topic by Jiménez and Bermúdez (2010) and Watanabe et al. (2013).

## 4.3 Influence of lubricants on temperature

The cooling abilities of scCO<sub>2</sub> have already been stated in machining tests (Cai et al., 2021). The measured temperatures in the pin were, as expected, significantly decreased by scCO<sub>2</sub> alone with respect to the dry tests, with a maximum reduction of 80°C. These temperatures are presented in Figure 8 versus the load values for two speeds at a lubricant rate of 4 mL/min. No significant difference in cooling was provided by the presence of the lubricants compared to the effect of scCO<sub>2</sub> alone. However, additives are known to contribute to heat removal (Pušavec et al., 2020). The authors currently lack explanations for the negative temperature results. Possible hypotheses include the additives not being activated under the tested speed conditions, suboptimal delivery techniques, or solubility issues, as stated in Section 4.1.

## 5 Conclusion and future work

In this study, different lubricants (ionic liquids, vegetable and mineral oil, water, and PEG) were paired to scCO<sub>2</sub> to investigate the potential decrease of friction, using a Hedenqvist-type tribological test. The analysis of the apparent friction coefficient and the sticking zone area confirmed the efficiency of ionic liquids at 100 m/min speed regarding lubrication. The other components, such as vegetable oils or water, though as efficient as industrial mineral oil, did not reduce the coefficient of friction as expected. Solubility studies are under investigation to find suitable supercritical conditions for better efficiency of dissolved oils in scCO<sub>2</sub> and define new efficient cutting fluids based on supercritical CO<sub>2</sub>.

## Data availability statement

The original contributions presented in the study are included in the article/Supplementary Material; further inquiries can be directed to the corresponding author.

## Author contributions

KK: writing—original draft, writing—review and editing, data curation, formal analysis, validation, and visualization. CB-D: data curation, formal analysis, investigation, methodology, validation, visualization, and writing—review and editing. HE-B: project administration, supervision, and writing—review and editing. FR: data curation, methodology, project administration, supervision, and writing—review and editing. GP: project administration, supervision, and writing—review and editing.

## Funding

The author(s) declare that financial support was received for the research, authorship, and/or publication of this article. This study is part of the French research project ScCRYO<sub>2</sub>, funded by INSTITUT CARNOT ARTS, CETIM, and the Bourgogne Franche-Comté Council.

## Conflict of interest

The authors declare that the research was conducted in the absence of any commercial or financial relationships that could be construed as a potential conflict of interest.

## Publisher's note

All claims expressed in this article are solely those of the authors and do not necessarily represent those of their affiliated

organizations, or those of the publisher, the editors, and the reviewers. Any product that may be evaluated in this article, or claim that may be made by its manufacturer, is not guaranteed or endorsed by the publisher.

## Supplementary material

The Supplementary Material for this article can be found online at: <https://www.frontiersin.org/articles/10.3389/fmtec.2024.1410292/full#supplementary-material>

## References

- Bergs, T., Pušavec, F., Koch, M., Grguraš, D., Döbbeler, B., and Klocke, F. (2019). "Investigation of the solubility of liquid CO<sub>2</sub> and liquid oil to realize an internal single channel supply in milling of Ti6Al4V," in Sustainable Manufacturing for Global Circular Economy: Proceedings of the 16th Global Conference on Sustainable Manufacturing, Lexington Kentucky, United States, October 2–4, 2018 (Procedia Manufacturing), 33 200–207. doi:10.1016/j.promfg.2019.04.024
- Cai, C., Liang, X., An, Q., Tao, Z., Ming, W., and Chen, M. (2021). Cooling/lubrication performance of dry and supercritical CO<sub>2</sub>-based minimum quantity lubrication in peripheral milling Ti-6Al-4V. *Int. J. Precis. Eng. Manuf.-Green Tech.* 8, 405–421. doi:10.1007/s40684-020-00194-7
- Courbon, C., Pusavec, F., Dumont, F., Rech, J., and Kopac, J. (2013). Tribological behaviour of Ti6Al4V and Inconel718 under dry and cryogenic conditions—application to the context of machining with carbide tools. *Tribol. Int.* 66, 72–82. doi:10.1016/j.triboint.2013.04.010
- Courbon, C., Sterle, L., Cici, M., and Pusavec, F. (2020). Tribological effect of lubricated liquid carbon dioxide on TiAl6V4 and AISI1045 under extreme contact conditions. *Procedia Manuf.* 47, 511–516. doi:10.1016/j.promfg.2020.04.139
- Dang, J., Zhang, H., An, Q., Ming, W., and Chen, M. (2021). Surface modification of ultrahigh strength 300M steel under supercritical carbon dioxide (scCO<sub>2</sub>)-assisted grinding process. *J. Manuf. Process.* 61, 1–14. doi:10.1016/j.jmapro.2020.11.001
- Davis, B., Schueller, J. K., and Huang, Y. (2015). Study of ionic liquid as effective additive for minimum quantity lubrication during titanium machining. *Manuf. Lett.* 5, 1–6. doi:10.1016/j.mfglet.2015.04.001
- Fan, X., Wang, Y., Zhou, Y., Chen, J., Huang, Y., and Wang, J. (2018). Experimental study of supercritical CO<sub>2</sub> leakage behavior from pressurized vessels. *Energy* 150, 342–350. doi:10.1016/j.energy.2018.02.147
- Goindi, G. S., Jayal, A. D., and Sarkar, P. (2018). Application of ionic liquids in interrupted minimum quantity lubrication machining of plain medium carbon steel: effects of ionic liquid properties and cutting conditions. *J. Manuf. Process.* 32, 357–371. doi:10.1016/j.jmapro.2018.03.007
- Gross, D., Appis, M., and Hanenkamp, N. (2019). Investigation on the productivity of milling Ti6Al4V with cryogenic minimum quantity lubrication. *MM Sci. J.* 2019, 3393–3398. doi:10.17973/mmsj.2019\_11\_2019098
- Hedenqvist, P., and Olsson, M. (1991). Sliding wear testing of coated cutting tool materials. *Tribol. Int.* 24, 143–150. doi:10.1016/0301-679X(91)90020-A
- Hyatt, J. A. (2002). *Liquid and supercritical carbon dioxide as organic solvents*. Archive Location: ACS Publications world Publisher: American Chemical Society. doi:10.1021/jo00200a016
- Jiménez, A. E., and Bermúdez, M. D. (2010). Ionic liquids as lubricants of titanium–steel contact. Part 3. Ti6Al4V lubricated with imidazolium ionic liquids with different alkyl chain lengths. *Tribol. Lett.* 40, 237–246. doi:10.1007/s11249-010-9633-1
- McHugh, M. A., and Krukonis, V. J. (1994) "Supercritical fluid extraction: principles and practice," in *Butterworth-Heinemann series in chemical engineering*. 2nd edn. Boston: Butterworth-Heinemann.28708798
- Meier, L., Schaal, N., and Wegener, K. (2017). In-process measurement of the coefficient of friction on titanium. 16th CIRP Conference on Modelling of Machining Operations (16th CIRP CMMO). *Procedia CIRP* 58, 163–168. doi:10.1016/j.procir.2017.03.212
- Meier, T., Gross, D., and Hanenkamp, N. (2021). Investigation of lubricating oils from renewable resources for cryogenic minimum quantity lubrication. *mm Sci. J.* 2021, 5069–5076. doi:10.17973/MMSJ.2021\_11\_2021154
- Outeiro, J. C., Umbrello, D., M'Saoubi, R., and Jawahir, I. S. (2015). Evaluation of present numerical models for predicting metal cutting performance and residual stresses. *Mach. Sci. Technol.* 19, 183–216. Publisher: Taylor and Francis eprint. doi:10.1080/10910344.2015.1018537
- Pereira, O., Rodriguez, A., Fernandez-Abia, A., Barreiro, J., and Lopez de Lacalle, L. (2016). Cryogenic and minimum quantity lubrication for an eco-efficiency turning of aisi 304. *J. Clean. Prod.* 139, 440–449. doi:10.1016/j.jclepro.2016.08.030
- Pušavec, F., Sterle, L., Kalin, M., Mallipeddi, D., and Krajnc, P. (2020). Tribology of solid-lubricated liquid carbon dioxide assisted machining. *CIRP Ann.* 69, 69–72. doi:10.1016/j.cirp.2020.04.033
- Rahim, E., Rahim, A., Ibrahim, M., and Mohid, Z. (2016). Experimental investigation of supercritical carbon dioxide (SCCO<sub>2</sub>) performance as a sustainable cooling technique. *Procedia CIRP* 40, 637–641. doi:10.1016/j.procir.2016.01.147
- Rech, J., Arrazola, P. J., Claudin, C., Courbon, C., Pusavec, F., and Kopac, J. (2013). Characterisation of friction and heat partition coefficients at the tool-work material interface in cutting. *CIRP Ann.* 62, 79–82. doi:10.1016/j.cirp.2013.03.099
- Sahab, A. S. A. S., Rahim, E. A., and Samion, S. (2017). Tribological performance of modified jatropha oil containing oil-miscible ionic liquid for machining applications. *J. Mech. Sci. Technol.* 31, 5675–5685. doi:10.1007/s12206-017-1108-y
- Supekar, S., Clarens, A., Stephenson, D., and Skerlos, S. (2012). Performance of supercritical carbon dioxide sprays as coolants and lubricants in representative metalworking operations. *J. Mater. Process. Technol.* 212, 2652–2658. doi:10.1016/j.jmatprotec.2012.07.020
- Tapoglou, N., Taylor, C., and Christos, M. (2021). Milling of aerospace alloys using supercritical CO<sub>2</sub> assisted machining. *Procedia CIRP* 101, 370–373. doi:10.1016/j.procir.2020.06.008
- Watanabe, S., Takiwatari, K., Nakano, M., Miyake, K., Tsuboi, R., and Sasaki, S. (2013). Molecular behavior of room-temperature ionic liquids under lubricating condition. *Tribol. Lett.* 51, 227–234. doi:10.1007/s11249-013-0130-1
- Wu, W., Zhang, J., Han, B., Chen, J., Liu, Z., Jiang, T., et al. (2003). Solubility of room-temperature ionic liquid in supercritical CO<sub>2</sub> with and without organic compounds. *Chem. Commun.*, 1412–1413. doi:10.1039/B302311G
- Yu, W., Chen, J., Ming, W., An, Q., and Chen, M. (2022). Feasibility of supercritical CO<sub>2</sub>-based minimum quantity lubrication to improve the surface integrity of 50% SiP/Al composites. *J. Manuf. Process.* 73, 364–374. doi:10.1016/j.jmapro.2021.11.022
- Yuan, Y., Wang, C., Yang, J., Zheng, L., and Weiqiang, X. (2018). Performance of supercritical carbon dioxide (scCO<sub>2</sub>) mixed with oil-on-water (OoW) cooling in high-speed milling of 316L stainless steel. *Procedia CIRP* 77, 391–396. doi:10.1016/j.procir.2018.08.301
- Zhang, H., Dang, J., An, Q., Ming, W., Chen, M., and Zhang, J. (2021). Investigation of machinability in milling of Inconel 718 with solid SiAlON ceramic tool using supercritical carbon dioxide (scCO<sub>2</sub>)-based cooling conditions. *Ceram. Int.* S0272884221034398 48, 4940–4952. doi:10.1016/j.ceramint.2021.11.032