



### **Science Arts & Métiers (SAM)**

is an open access repository that collects the work of Arts et Métiers Institute of Technology researchers and makes it freely available over the web where possible.

This is an author-deposited version published in: <https://sam.ensam.eu>  
Handle ID: <http://hdl.handle.net/10985/8338>

#### **To cite this version :**

Livio DE LUCA, Michel FLORENZANO, Philippe VERON - Reverse-engineering of architectural buildings based on an hybrid modeling approach - Computers and Graphics - Vol. 30, n°2, p.160-176 - 2006

Any correspondence concerning this service should be sent to the repository

Administrator : [scienceouverte@ensam.eu](mailto:scienceouverte@ensam.eu)



# Reverse engineering of architectural buildings based on a hybrid modeling approach

Livio De Luca<sup>a</sup>, Philippe Veron<sup>b,\*</sup>, Michel Florenzano<sup>a</sup>

<sup>a</sup>UMR CNRS/MCC 694 MAP—Modeles Et Simulations Pour L'Architecture, L'Urbanisme Et Le Paysage, Équipe GANSAU—Groupe De Recherche Pour L'Application Des Methodes Scientifiques A, L'Architecture Et L'Urbanisme, École D'Architecture De Marseille, 184, Avenue De Luminy 13288 Marseille, France

<sup>b</sup>UMR CNRS 6168—LSIS—Laboratoire Des Sciences De L'Information Et Des Systemes, École Nationale Supérieure D'Arts Et Metiers, 2, Cours Des Arts Et Metiers, 13617 Aix-En-Provence, France

---

## Abstract

This article presents a set of theoretical reflections and technical demonstrations that constitute a new methodological base for the architectural surveying and representation using computer graphics techniques. The problem we treated relates to three distinct concerns: the surveying of architectural objects, the construction and the semantic enrichment of their geometrical models, and their handling for the extraction of dimensional information. A hybrid approach to 3D reconstruction is described. This new approach combines range-based modeling and image-based modeling techniques; it integrates the concept of architectural feature-based modeling. To develop this concept set up a first process of extraction and formalization of architectural knowledge based on the analysis of architectural treaties is carried on. Then, the identified features are used to produce a template shape library. Finally the problem of the overall model structure and organization is addressed.

*Keywords:* Architectural knowledge; Laser scanning; Image-based modeling; Range-based modeling; Feature-based modeling

---

## 1. Introduction

The understanding of the architectural and patrimonial heritage studies can be widely improved nowadays by using the 3D reconstruction of the real buildings. This way is also efficient to document historic buildings and sites for their reconstruction or restoration, to create resources for researchers and to analyze their historical evolutions.

The problem of spatial data acquisition has greatly progressed in these last years due to the introduction of

laser scanning technologies [1]. In parallel, the digital images-based techniques introduce the possibility to produce 3D models of architectural buildings from photographs [2,3]. These two kinds of techniques are different both in terms of devices (on the one hand a laser sensor and on the other hand a simple camera) and in terms of required 3D reconstruction techniques. The advantages of the laser scanning are its capacity to store large 3D point clouds acquired with a high speed and a high level of precision. Nevertheless, while the acquisition phase can profit of automatic procedures, the point clouds post processing requires many manual actions when the objective is to analytically represent an architectural object [4]. Moreover, the resulting polyhedra are often too heavy for an efficient use in whole

---

\*Corresponding author. Tel.: +33 442 93 81 24; fax: +33 442 93 81 41.

*E-mail address:* philippe.veron@ensam.fr (P. Veron).

building reconstruction, especially if the final goal is to produce a digital mock-up allowing 3D real-time navigation. Considering this aspect, the models obtained by image-based modeling and rendering techniques are very light because they appeal to the texture mapping for the description of shape details. It is however possible to consider range-based and image-based modeling as complementary techniques [5,6].

Regardless of the acquisition device, before starting the treatment of the data sets, it is essential to take into account the representation problems as the reconstruction process makes a geometrical interpretation of the architectural elements. Indeed, if the reconstruction techniques provide good surface reconstructions, they do not necessarily integrate the semantic interpretation of the architectural geometry. In fact, architectural surveying is a reverse process which, starting from the real object, rebuilds a digital model and interprets the idea upstream of its realization [7]. In an architectural building project two essential points of view are to be considered. The first one is related to the architect that has an ideal, perfect design reference and the second one to the concrete and imperfect real realization. In the same manner, the architectural surveying can be articulated around two points of view. The first one is related to crude processing of data sets that produce an imperfect digital model and the second one is related to the exploitation of semantic information producing an enhanced design model of the real building.

This way, the extraction of relevant information from the acquired 3D data, according to the architectural drawing conventions, forms an important problem that must be addressed.

In this article a hybrid modeling approach combining range-based and image-based modeling techniques is proposed. The approach has been implemented into a 3D reconstruction tool dedicated to architectural buildings. Its efficiency is demonstrated on several real-field studies.

The proposed approach uses a hybrid registration of two types of digitalized sources (point-cloud and digital images) in order to provide a complete support for the 3D modeling process. This process is supported by specific design tools developed to allow the surface reconstruction starting from relevant profiles and using a library of architectural shapes in order to produce semantic representations of architectural elements and organize them into hierarchical structures.

The paper is organized as follows. Section 2 presents a summary overview of the image-based and range-based modeling techniques. Section 3 discusses the problem of the semantic representation of architectural elements. Section 4 presents a general overview of the proposed approach. Section 5 explains the hybrid registration of different digitalized sources. Section 6 describes the design tools developed for 3D surface reconstruction.

Section 7 presents the tools set up for the model structuring and enrichment. Finally, Section 8 concludes this paper and suggests some future works.

## 2. Current surface reconstruction approaches

### 2.1. Image-based modeling and rendering

Image-based modeling systems divide the 3D reconstruction process into three main steps (cf. Fig. 1). First, correspondences between a set of homologous points on two or more photographs are interactively established. The 3D position and orientation of the camera (i.e. its extrinsic parameters) are determined [8]. They allow to link 2D image pixels to 3D point co-ordinates. A self-calibration process follows that computes the intrinsic camera parameters (usually, only the focal length) in order to obtain a metric, up to scale reconstruction [9].

The second step consists in a geometrical modeling starting from the recovered co-ordinates. The basic geometric shape of the object is built interactively using primitive polyhedral elements. The third step consists in the extraction of textures from the photographs.

### 2.2. Range-based modeling

There are two main kinds of range sensors, each using a different system. The first one is the triangulation-based system that projects light in a known direction from a known location. The second system is based on a time-of-flight measurement. It measures the delay between emission and detection of the light reflected by the surface, and thus the accuracy does not deteriorate rapidly as the range increases.

The scanning configuration determines the point density. The result is an organized point cloud, stored as an array or a range image.

A single-range image is usually not sufficient to cover an architectural object. The required number of scanning locations depends on several parameters such as the shape of the object, its number of self-occlusions, the obstacles in its front, and its size compared to the sensor range characteristics. All the 3D point-clouds (i.e. range images) must be registered in a unique reference coordinate system. Several registration techniques are available, based on positioning targets or shape features in the digitized scene.

Once the range-images are registered in a global reference system, they can be used for modeling. The surface reconstruction using the 3D point-cloud can be carried out with different modeling techniques (cf. Fig. 2) based on:

- The positioning of pre-defined geometrical primitives (points, lines, curves, volumes).

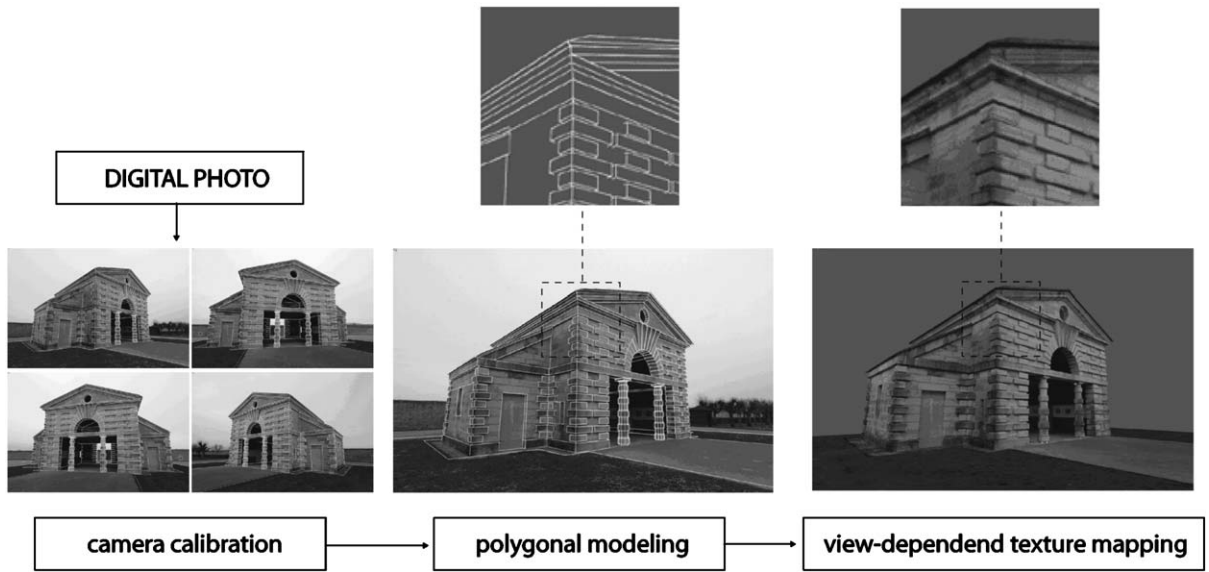

Fig. 1. Image-based modeling and rendering process applied to the surveying of the "Ecuries du directeur", Saline Royale d'Arc-et-Senans, France.

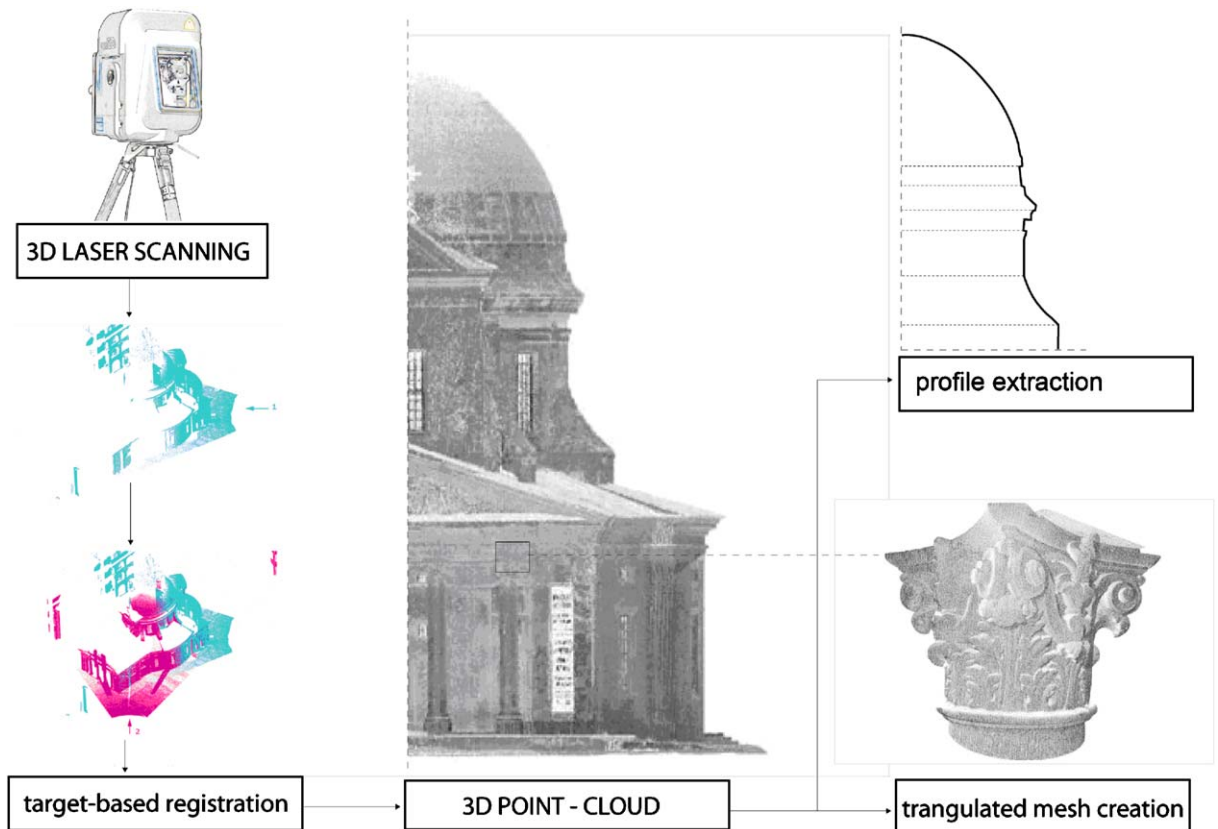

Fig. 2. Range-based modeling process applied to the surveying of the "Chapelle de la Vieille Charité", Marseille, France.

- The automatic segmentation of the 3D point-cloud and the recognition of form features in a library [10].
- The generation of polyhedral representation using triangulation algorithms working on the point-cloud [11].

This last method is often completely automatic and allows precise surface reconstructions. Other treatments can be used to extract relevant sections on the polyhedra.

### 3. Architectural knowledge extraction and formalization

The study of the drawing convention in the history of the architectural representation has a double finality: the first leads to the representation, the second one to the surveying of the object. These two analytic points of view of the architectural elements are strictly interdependent [12]. The knowledge extraction problem consists in identifying the genesis of the element shape in order to define both the appropriate way for its measurement and for its representation. To this end, architectural knowledge rules have to be formalized. An architectural knowledge system can be described as a collection of structured objects, identified through a precise vocabulary. Several studies led to the definition of classification methods for architectural elements based on levels of abstraction of the architectural space [13]. These classifications are based on the study of the architecture treaties which organize the building art knowledge relatively to different historical periods. Many treaties develop an identity coding of architectural elements. This identity is normally expressed through a hierarchical description of all the elements that make a build unit (cf. Fig. 3).

In [14], by means of representation convention, each architectural element is expressed by a geometrical

description level (lines, curves), a topological relations level (parallelism, concentricity, etc.) and a spatial relations level (proportions, harmonic reports/ratios).

The topic of reverse engineering processes of architectural buildings returns to the extraction of these three dimensions starting from the 3D data acquired on a real building. Based upon various sources of knowledge (including the study of particular cases), it consists on extracting drawing rules, formalizing them and making their appropriate for a digital translation into a semantic-based template library. In architecture, the shape analysis can be led by the identification of the process allowing its geometrical construction. Indeed the use of the drawing goes beyond the simple work of passive transcription of a given reality because the drawing, in architecture, is mainly a analysis and conceptualization tool and also projection one [15].

Understanding the true geometrical nature of an architectural element consists, above all, in identifying the atomic entities that take part, by mechanical combination, in its composition. However, this kind of approach is effective only when referring to the descriptive and representation systems that led the design of the shape. We turn our attention to the profiled elements of the classical language, because their study is supported by many theorizations developed as from the 15th century. They also constitute a good example of relation between geometry and architecture. While being based on historical sources and direct observations, Rattner [16] developed a classification of the moldings by showing in a systematic way the part they play in the building design. The author defines the mouldings as the smallest physical units, the atoms of the classical architecture, and provides a method to understand the shape of the architectural elements according to their combination. This classification is based on a variety of 14 moldings (cf. Fig. 4) and uses several criteria of regrouping. With regard to the combination of the mouldings in profiles, the aspect

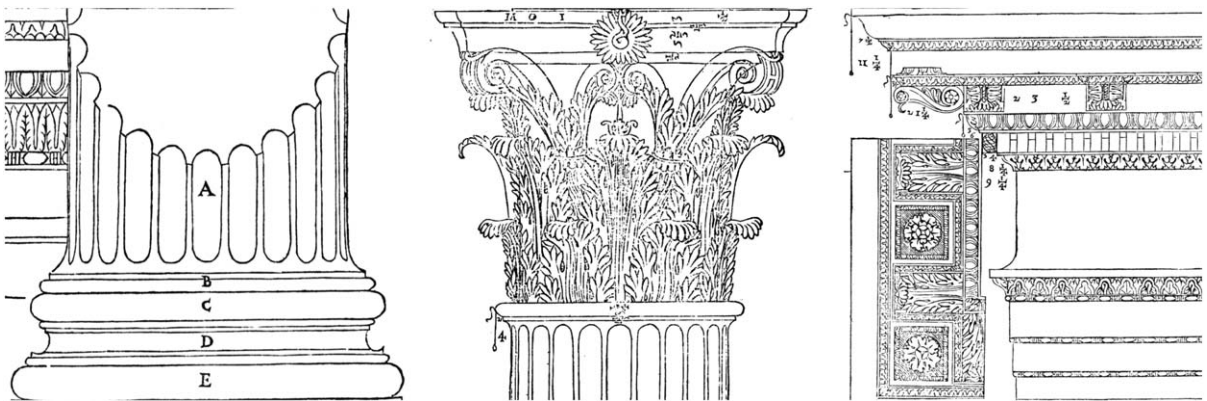

Fig. 3. Three elements of the Corinthian order from the Palladio's treaty [14]: base, capital, entablature.



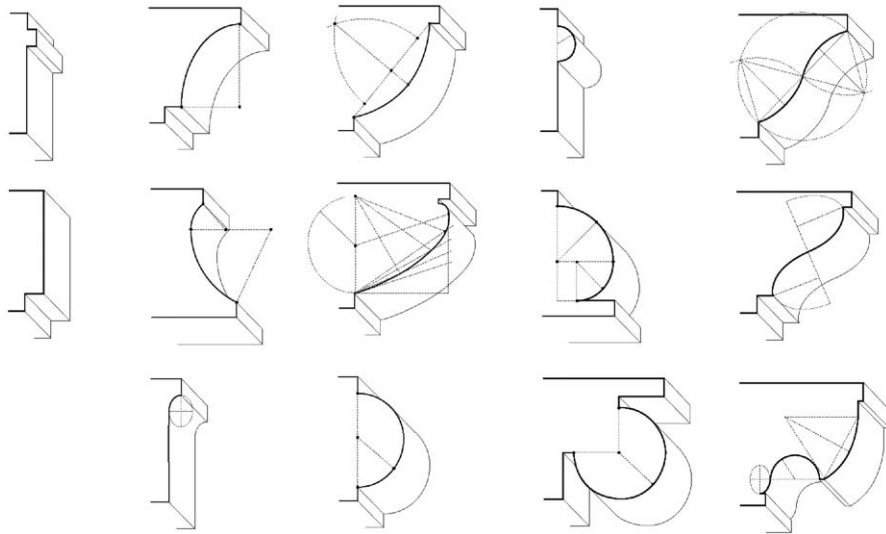

Fig. 4. Classification of mouldings of the classical language [16].

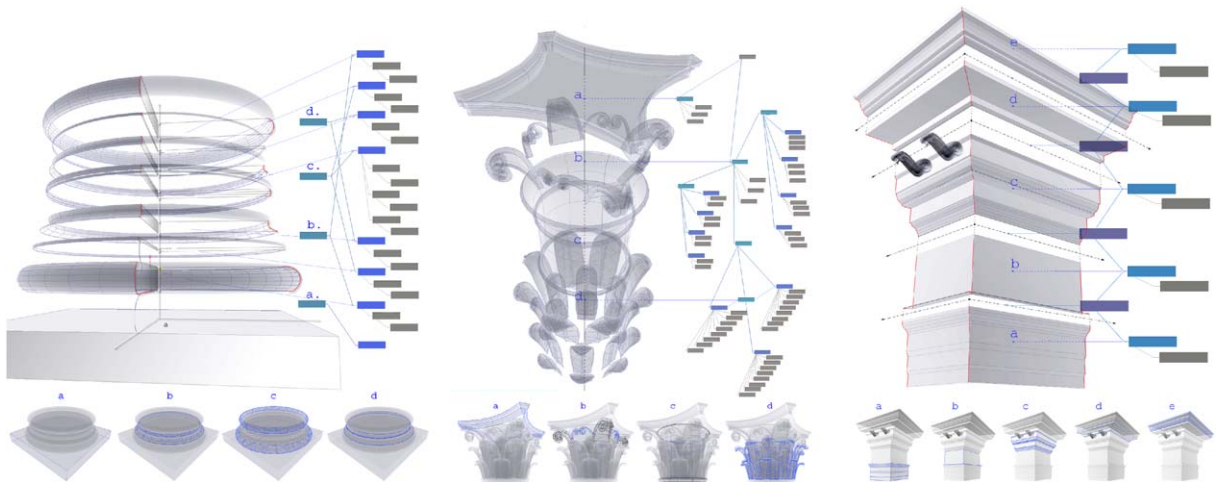

Fig. 5. Semantic representation of the three elements of the Corinthian order: base, capital, entablature.

which interests us most from a geometrical analysis point of view of the architectural element is that of coordination [17].

The relative localization of a molding and its proportions imply the coordination of various parts in order to compose an ordered unit. This is usually reached by means of plane alignments. Concerning the formalization of this type of elements, our approach is based on a three level description (cf. Fig. 5). A network of curves associated with a modeling procedure constitutes the geometrical description level of the architectural element (details in Section 6.2). The topological relations that connect the sub-elements between them are expressed through geometrical constraints between

surfaces (i.e. faces or axis coincidences, distances, angles, etc.). Four kinds of constraints are used: position, orientation, scale and contact constraints. Finally, a hierarchical organization of the sub-elements provides a structured representation of the entity.

#### 4. Overview of the proposed hybrid reconstruction approach

In order to produce the 3D model of a building its constituting parts must be represented geometrically and the aspect of its surfaces has to be reproduced. To this end, the proposed approach is divided into three main phases.

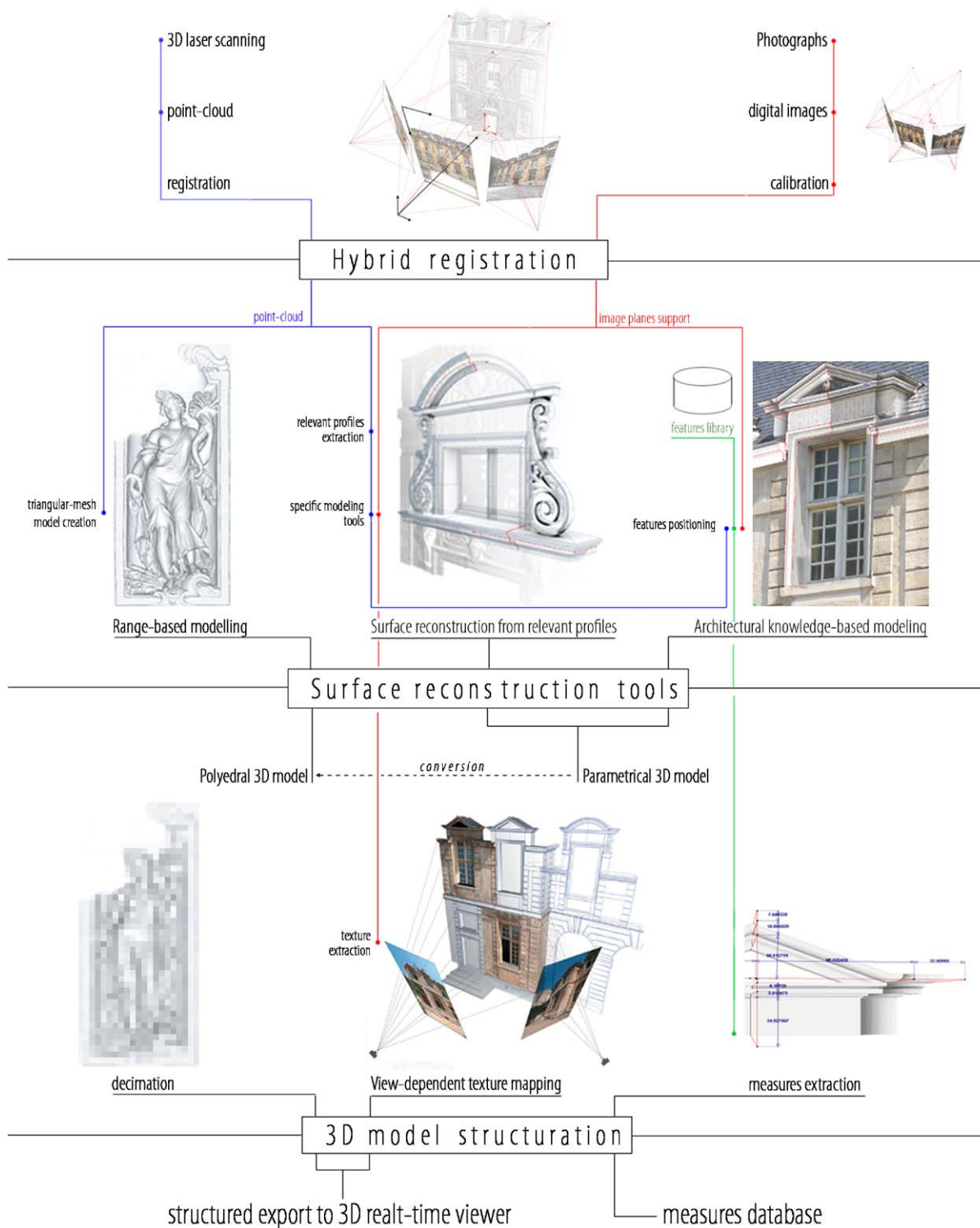

Fig. 6. Schematic representation of the hybrid approach proposed.

The first one is the surveying of the considered building including its metric and photometric properties. The second one is the construction of the geometrical building model and its enrichment by photometrical and dimensional information. The last phase focuses on the semantic organization and configuration of the 3D model in order to allow an efficient handling of the resulting digital mock-up.

Many researches have focused on the combination of different techniques in a unique reconstruction approach. For example, [18] combined structured light 3D sensing and photometric stereo to model Michelangelo's Pietà. The possibility of combining laser scanning with image-based modeling and rendering [19] has also been explored.

Nevertheless, if these solutions theoretically allow an accurate geometric reproduction of a building with all its details, the problem of producing a semantically enriched model still remains [11]. In fact, a triangulated-model can be appropriate for the representations of artistic objects, such as sculptures, by reproducing the connection between matter and modeling. But this type of geometrical representation is not efficient when the definition of geometrical relations between different parts of the shape is required to describe the proportions of typical objects. With regard to the array of classical architectural shapes, the relevant information that must be acquired, recognized and modeled can be found in a collection of relevant profiles describing these shapes on the basis of the conventions of architectural drawings.

The hybrid modeling approach proposed is organized as follows (cf. Fig. 6):

- (a) *A surveying process* (detailed in Section 5) of the morphology, the dimensions and of the superficial aspects of the building. Combining range-based and image-based techniques, the surface reconstruction process uses on the one hand the 3D point-clouds to extract relevant profiles and to create triangulated-meshes, and on the other hand the digital images to cover shadow areas in the 3D point-clouds, to recover additional coordinates and to extract textures for mapping.
- (b) *A modeling process* (detailed in Section 6), which reconstructs the geometrical model using the information resulting from the surveying phase. In the modeling environment developed, 3D point-clouds and digital images constitute respectively the metric and the visual supports. For this phase, the approach proposed introduces and exploits the architectural knowledge as a key support to relevantly interpret and reproduce the architectural shapes. A formalization process produces features libraries that are instantiated in the 3D point-cloud using a localization and fine positioning process.

- (c) *A 3D model enrichment process* (detailed in Section 7), which allows to organize the object representations in a hierarchical structure and allows the extraction of dimensional information from the instantiated object parameters.

The proposed approach has been implemented into a 3D reconstruction tool developed in Alias WaveFront MEL (MEL: Maya Embedded Language). The rest of the paper describes the developed procedures starting from the conversion of the gathered data, and finishing with a structured export towards a real-time 3D engine for the future handling of the digital mock-up produced. The approach is illustrated using a case study: the 3D reconstruction of the "Hôtel de Sully" in Paris.

## 5. Hybrid registration of the different digitized sources

Architectural objects, because of their dimensions, rarely allow a complete and homogeneous acquisition in one single recovering system. A MENSIS GS200 ToF laser scanner is used for recovering dimensional information. Several chosen stations allow an adequate recovering of the complete building. Several local high-density digitalizations are required to survey the relevant profiles and the architectural details such as decors and sculptures. In a recent paper [21], a method that allows building relevant profiles by coupling a digital camera with a range sensor and exploiting computer vision techniques has been described. To this end, in parallel with the range-based recovering, a photographic acquisition is carried out using a digital camera and different optic characteristics. A particular attention is given to the acquisition of three reference points both on the range images (i.e. 3D point-clouds) and on the digital images, thus allowing the establishment of a common global reference system for all the surveyed data.

3D point-clouds are classically stored in ASCII file format. In MEL, the entities most adapted to represent 3D point-clouds are the particle systems. We developed a tool able to convert 3D point-clouds into particle systems for their visualization and manipulation. This tool automatically recognizes in the ASCII file structure the cloud type and produces the direct transformations of co-ordinates according to their measuring unit and orientation. Finally, a .ma file (AliasWavefront Maya ASCII file) containing the converted co-ordinates with their color (intensity or RGB) attributes is outputted.

To connect the two types of digitized sources, acquired in the surveying process (point-cloud and photographs), we use a procedure of "spatial resection" [22]. This procedure consists in estimating the projection



matrix of the camera's geometrical model (associated to the photograph) starting from correspondences selected, respectively, in 3D space and on the 2D image. For this task, we use de Tsai calibration method [23]. This method uses a calculation in two steps: firstly one calculates external parameters (position and the orientation), secondly the internal parameters (focal length and distortion) of the camera used for photographs. The results of the calibration consist on a image matching on the point-cloud (cf. Fig. 7). The goal of this procedure is to enrich the geometrical reconstruction process with photography information in order to create an enhanced modeling environment. Effectively, a photograph offers an ideal support to identify relevant information (vertex, contours, profiles, etc) of analyzed shapes. Image matching is also exploited to enrich the 3D model with textures (Section 7.3).

## 6. Specific surface reconstruction tools set up

Beyond the characteristics relating to the architectural periods or the currents to which the building belongs, two fundamental scales are identified in a reconstruction problem: the architectural elements scale and the decoration one.

For architectural elements two different approaches are used:

- surface reconstruction method working from relevant profiles extracted from the 3D point-cloud,
- architectural knowledge-based modeling method.

This last uses a library of parameterized architectural primitives which can be instantiated (i.e. dimensioned and positioned) on the 3D point-cloud.

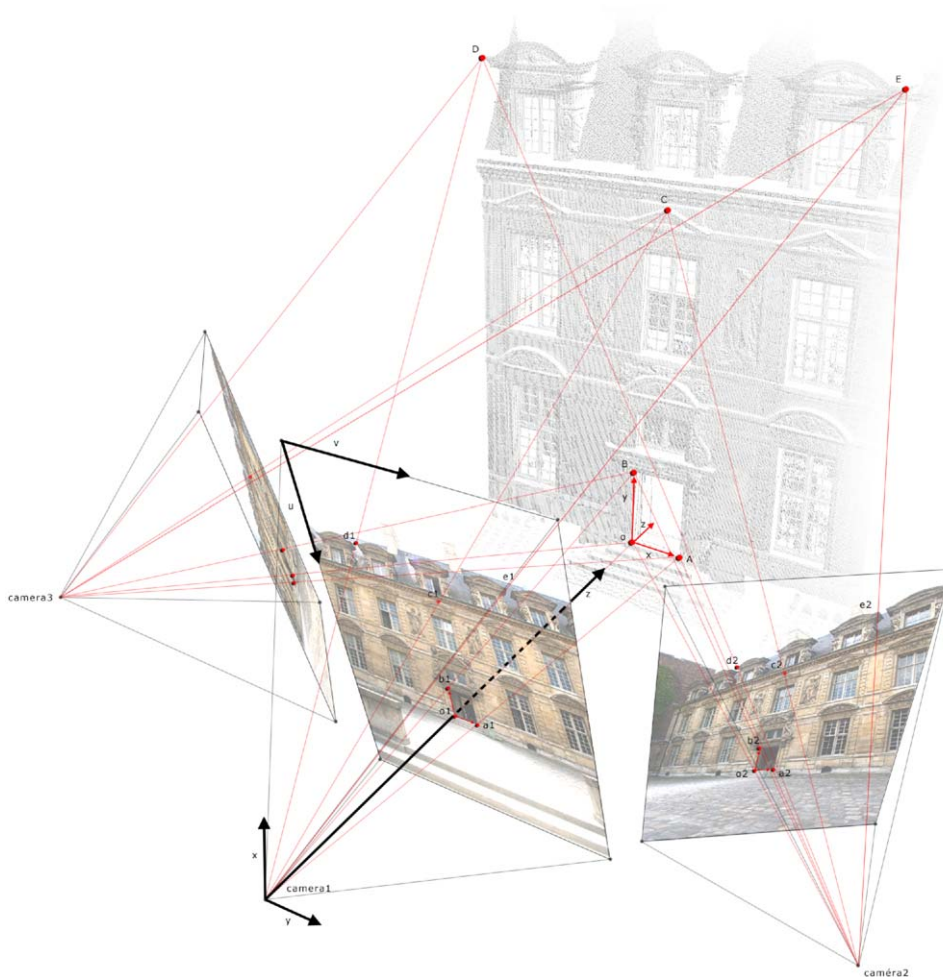

Fig. 7. Hybrid registration of different digitized sources.

When the geometry of the surveyed object is more complex (i.e. decorations, sculptures) automatic triangulation methods and polyhedral decimation techniques are used.

### 6.1. Surface reconstruction from relevant profiles

The intersection of a point-cloud with a relevant plane allows identifying point sets describing characteristic profiles of the architectural elements in order to exploit them for the surface reconstruction process. The tool developed uses an easy-to-handle plane in the space (cf. Fig. 8). This plane is composed by a camera (with orthogonal projection) defined by an in-depth limited visual pyramid. A distinct window only displays the entities ranging between the two ends of the visual pyramid of the camera. The user can thus plot B-Splines curves projecting them directly on the intersection plane.

The curves extracted from the intersection plane constitute the surface descriptors, which can be generated using modeling functions (cf. Fig. 9). For architectural element reconstruction, five surface generation operators have been retained and customized to cover the encountered cases: linear extrusion, path extrusion, surface revolution, boundary and planar surface generation.

### 6.2. Architectural knowledge-based modeling tools

To propose to the user pertinent knowledge-based modeling tools, the first step consists in describing in a theoretical way an architectural element (i.e. definition of its generic model: a template), then the second one consists to identify the vocabulary that allows to express its sub-elements and the composition rules that govern its scheduling.

To this end the treaties of architecture that capitalize the knowledge of the art of building are used. Information produced from 3D acquisition is then used to instantiate the entity templates and thus to build the representation.

The definition of our formalization approach is based on three distinct concerns:

- interpretation of knowledge linked to the shape,
- definition of methods for its geometrical construction,
- identification of relationships between parts that constitute shape.

The classification we presented in Fig. 4 shows that the study of the shape of profiled elements requires a geometrical analysis their commons characteristics. In an architectural profile a certain number of moldings

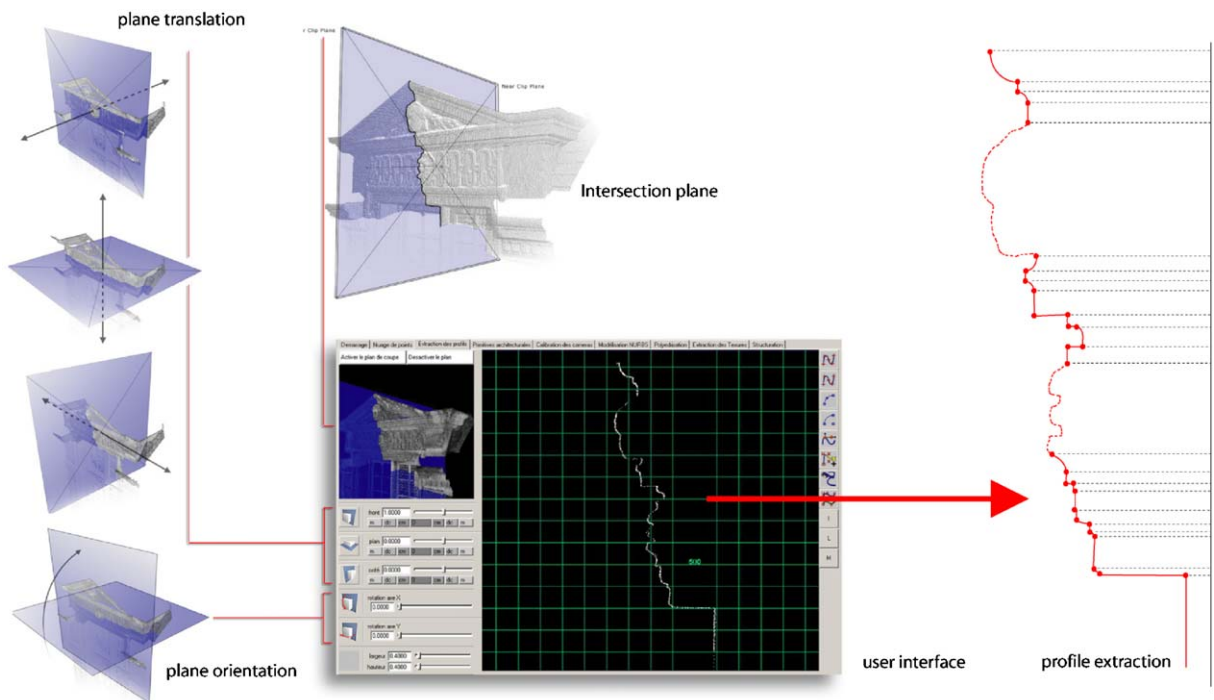

Fig. 8. Schematic representation of the profiles extraction tool's interface.

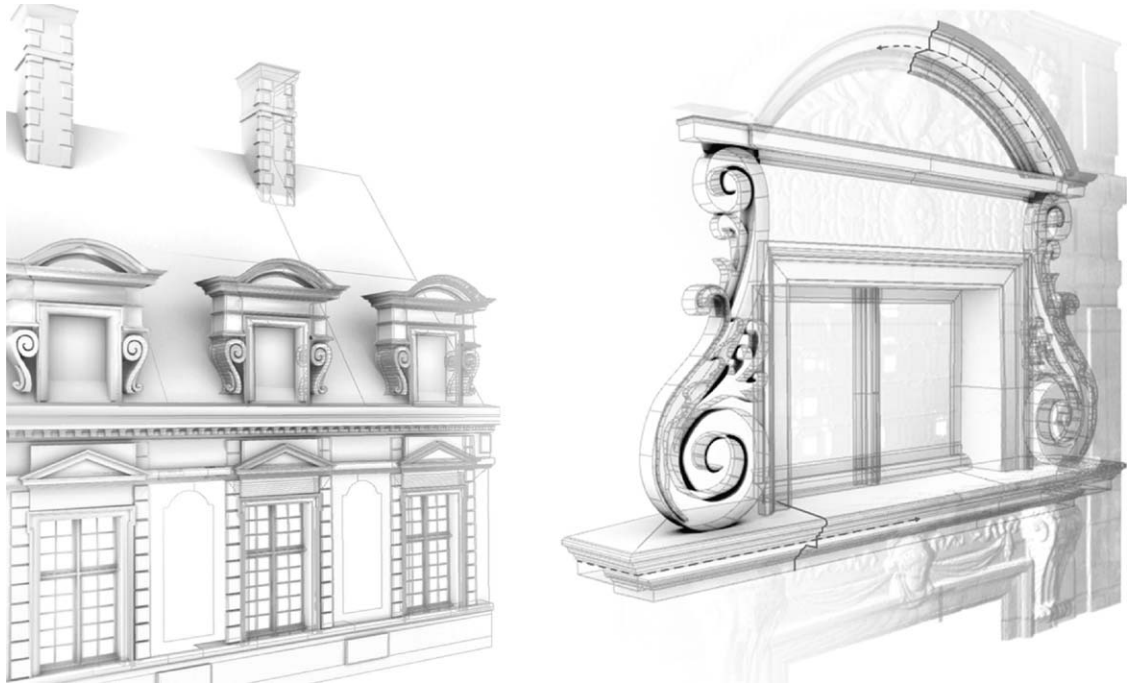

Fig. 9. Surface reconstruction by customized tools.

results from the combination of basic elements. With the geometry as central point of view, a comparative analysis of the traditional mouldings enables us to extract a series of conclusions:

- Any moulding results from a combination of linear segments or arcs.
- Any geometrical transition in a profile (or inside a moulding) is based on orthogonality between two construction plans.
- Complex parts of a moulding (concave or convex) result from the deformation of its bounding box or from a polycentric construction of tangent arcs.

With regard to the shape of a profiled element one can observe that:

- Any surface results from a generating profile and a directing path.
- The generating profile and the directing path are always in condition of orthogonality.
- Any directing path uses the same geometrical entities that composes moldings, but on a different scale.

Starting from these reports, we base our analytic approach on the formalization of knowledge connected to the architectural shape with the aim of extracting from them the principles of its geometrical construction.

We base the formalization of architectural elements on a network of specific nodes developed in MEL. MEL's core uses a data flow paradigm [24]. This core is incorporated in the Dependency Graph (DG). The data and their operations are encapsulated in the DG as *nodes*. In order to perform some complex modification to data, a network of simple nodes is created. Each node has one or more properties associated with it. These properties are commonly defined as attributes. An entire geometric mesh or NURBS (Non-Uniform Rational B-Splines) surface can be stored as an attribute in a node.

#### 6.2.1. First level features: moulding

The first phase of our analysis consists in the identification of geometrical primitives exploitable in a mechanical combination to create profiles (cf. Fig. 10). Each node of this level contains the essential attributes according with the entity position, orientation, origin and dimensions.

#### 6.2.2. Second level features: profiles

The second level of description results from a mechanical combination of first-level features. This combination is based on a logic of upward aggregation according to the vertical axis of a construction plane and it is carried out by a heritage of the position attribute (translation vector): the node origin of a moulding is constrained with the node anchoring of the moulding that precedes it in the chain. (cf. Fig. 11).

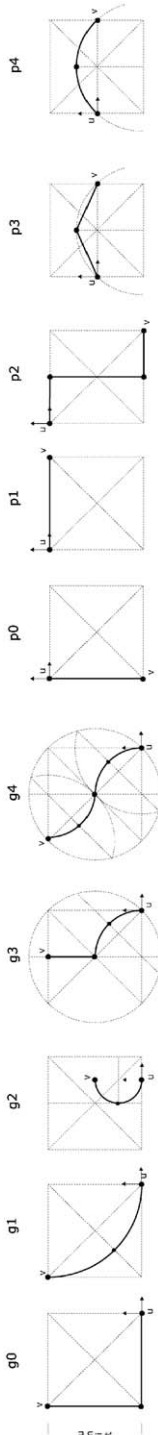

Fig. 10. A set of geometrical primitives for the construction of profiles and extrusion paths.

On each level of the progressive combination, we modify the attributes width and height of the corresponding first-level feature: we deform the bounding box of the feature to which is connected its geometrical representation (B-Spline curve). Grouping atoms in profiles is established according to the procedures of modeling. For a large variety of surfaces two profiles are sufficient. It is only necessary to identify the generator and the director of surface.

### 6.2.3. Third level features: extruded profiles

This level of the description is based on the concept of the surface construction history. Surface is indeed generated by node extrude function (linear, curved or combined) which receives geometrical information of a node profile and of a node extrusion path. Once the surface generated, this two last nodes are connected to the node extruded surface. That makes it possible to update surface according with transformation of any 1° level feature composing the profile (cf. Fig. 12). We base the procedures of modeling on a extrude function: the geometry of the generation profile is extruded along the parametric space of the directing profile.

### 6.2.4. Fourth level features: intersected surfaces

The last level of description defines the way in which various surfaces are organized together. For the majority of architectural elements that we took into account this organization results from the simple grouping of several surfaces (union of two or several distinct parts), or of an intersection between the parts of the element (Boolean functions).

The union between two surfaces can be established by a constraint introduced between two profiles. For other elements, more complex relations come into play. We introduce in the network an intersection node (cf. Fig. 13). This node creates a curve on the intersection between two surfaces. The node intersection uses two surfaces as entries. As in the cases of the surface generation starting from profiles, the intersection between two surfaces is updated at any modification of the entry nodes.

## 6.3. The features library

The formalization approach offers an interesting perspective on the possibility to organize a features library starting from the analysis of architectural treaties or the study of particular elements. The database recording organizes the elements description into 3 main blocks:

- General information on the primitive: creation date, author, context, etc.
- Description source: treaty, manual, photography.
- Geometrical and parametrical description of the entity.

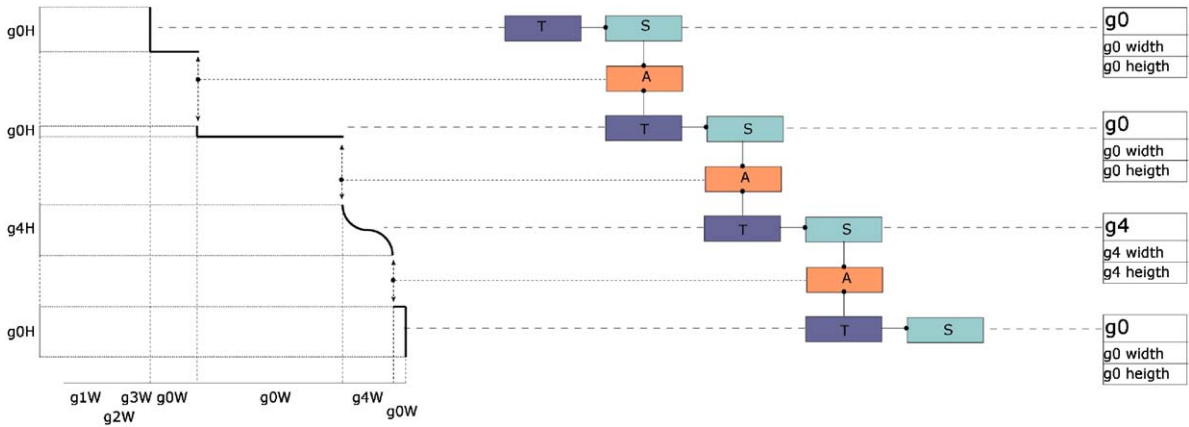

Fig. 11. A combined profile: T, transform node, S, shape node; and A, constraint node.

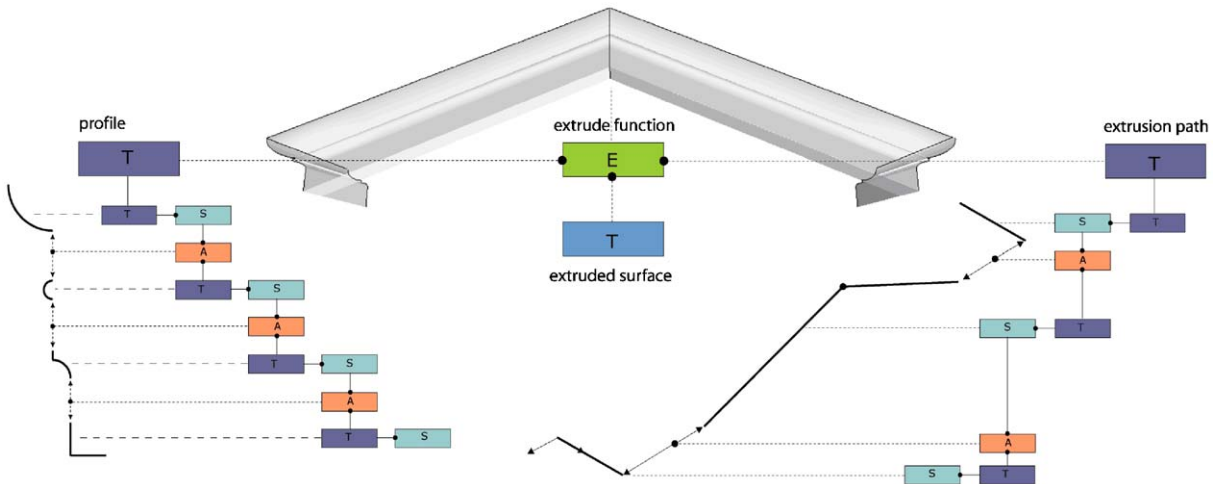

Fig. 12. A combined profile and extrusion paths: E, extrusion node; T, transform node; S, shape node; and A, constraint node.

We currently store the data into a relation database in a pre-established structure. We intend to reproduce the whole description structure in eXtensible markup language (XML). One of the most important advantages of this approach is the possibility to separating the description of the elements from their geometrical representation. The goal is to preserve the data independently of a specific modeling language. In fact, several methods of interpretation and geometrical translation of the feature's descriptions could exploit the collected knowledge.

Actually we develop a solution for sharing a features library during the modeling phase. We introduce a Web Browser inside an interface layout by a specific MEL command. This browser allows receiving MEL scripts originating from a distant site. The browser uses Gecko

as a layout engine and Mozilla Open Source to visualize the Web contents. Once an element is selected on the page showing the database records, a PHP script interprets the descriptions stored in the database and generates a MEL script for the creation of the feature into the modeler.

#### 6.4. Positioning of models library

Once the features generated into the 3D modeler, the concept of construction history on which the formalization approach is based guarantees the relationship between the profiles and the associated surfaces (cf. Fig. 14).

The feature maintains the structure of the formalized constraints and exploits it for the phase of positioning



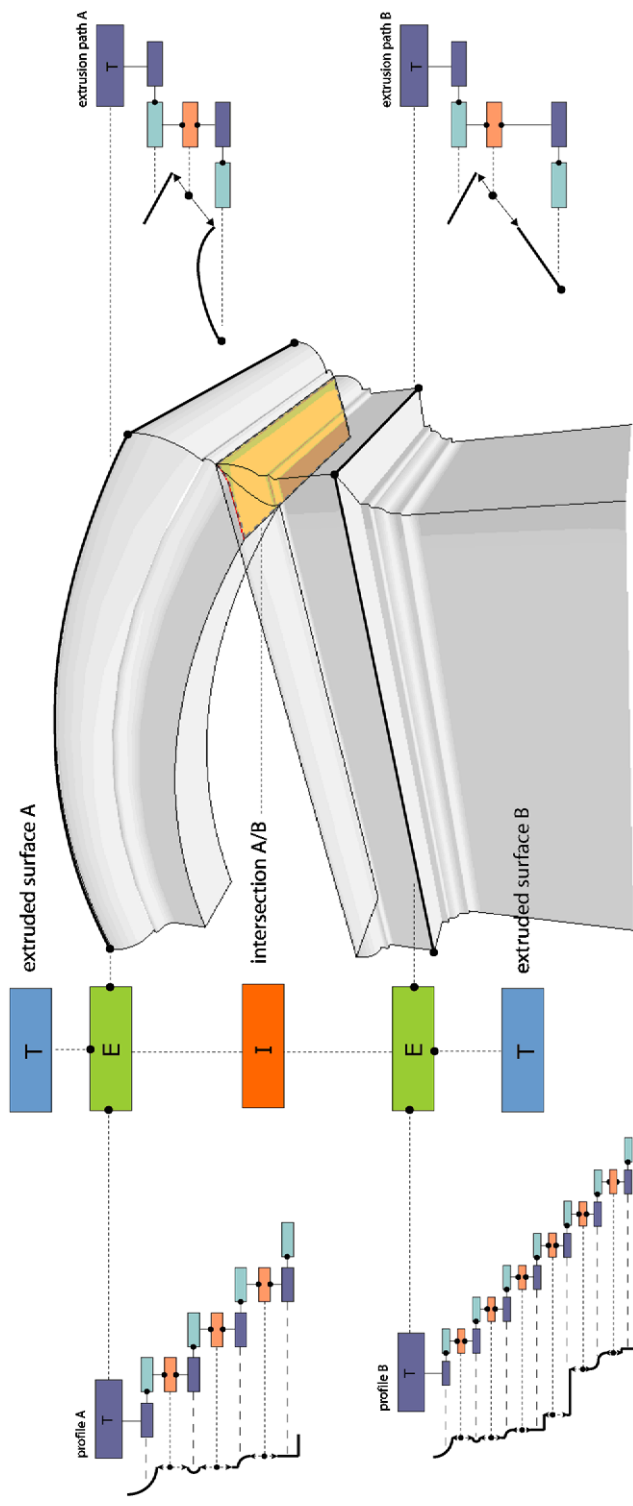

Fig. 13. Intersection function applied to two extruded surface; I, intersection node; E, extrusion node; T, transform node; S, shape node; and A: constraint node.

on the point cloud. The process of positioning is based on three steps.

- First, one introduces the primitive into the scene inside a bounding box defined by two intersection planes (horizontal and vertical). Translations, rotations and scaling may be applied to the whole primitive and its positioning can be controlled in real time. In this phase, one just seeks to locate the ends of the element without being concerned with the effective coincidence between the primitive and the cloud.
- The second phase consists of an under-constraint deformation of the profiles. A dedicated tool allows the direct control of the profile deformation on its construction plane. This planes form a support for the

positioning process. The deformation logic follows an upward sequence. Thanks to the chain of formalized constraints, the deformations applied to a profile determine the update of the positions of the others profiles on the chain and the related surfaces.

- The third phase (optional) makes it possible to control the lowest level of description of the primitive. In this case, the transformations can be applied to the control points of the B-Splines curves. This phase is important to finely adapt the profiles on the point-cloud.

At the end of the process, the hybrid registration (Section 4) allows to position the primitive on the point cloud with the support of the photographs (cf. Fig. 15).

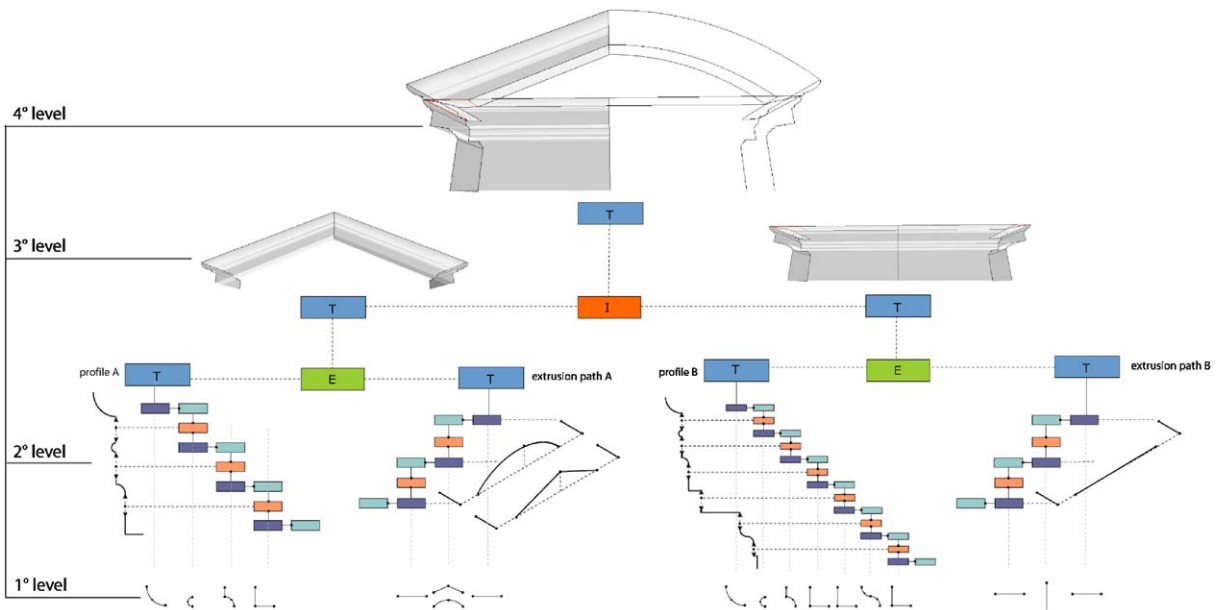

Fig. 14. Intersection function applied to two extruded surfaces.

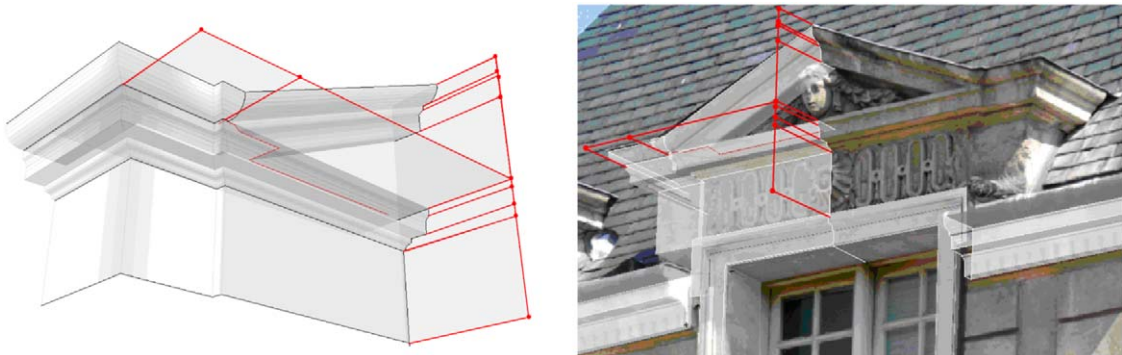

Fig. 15. Feature positioning and fine-tuning.

This procedure is currently completely manual. However, its organization in stages of progressive positioning, makes it possible to integrate automatism. Best-fit methods are surely to take into account to automate the second and the third phase of the positioning process.

## 7. Digital mock-up structuring and enrichment

### 7.1. The extraction of dimensional information

One of the most interesting exploitation of the knowledge-based modeling tool consists in the possibility of creating, at the same time the feature shape is instantiated, an organized structure of relevant measurement. In fact, every moulding (set of first level features) of the formalized primitive can be associated to a label. After deformation every label associated to a part of the shape obtains a dimensional value. The modeling process based on the use of architectural primitives thus becomes a way of structuring of an organized abacus of dimensional information (cf. Fig. 16).

### 7.2. Hierarchical structuring

To allow an efficient exploitation of the digital mock-up produced, the proposed approach ensures the organization of the model in parts and sub-parts and the identification of their reciprocal relations in order to guarantee a correspondence between the hierarchical description of the building model and its geometrical representation. The structuring tool developed this way

is based on simple grouping operations assisted by a graphic interface that allows the visualization of the labels and connections between the elements of the model.

### 7.3. Texture mapping

The texture extraction process uses the calibrated photographs and transforms them into image planes inside the 3D scene according to the tool described in Section 5. The texture definition starts with a shading node creation. Then, the Lambert type appearance we created is connected to a 2D texture node identified by the path to a file image.

Once the projection methods deduced from the properties of the calibrated camera and the photographs transformed into a mapping system, the interface allows the selection of an object into the scene and of photography into the browser to carry out the texture extraction and mapping. A new material node is automatically connected to the texture obtained by using a backing operation (cf. Fig. 17).

Polyhedral decimation algorithms previously developed [25,26] are used to produce various levels of detail of each object of the scene. Future works will focus on the dynamic handling of these LOD during the interactive navigation into the 3D scene.

## 8. Conclusions and future works

A complete approach has been proposed to produce enriched digital mock-ups of patrimony buildings

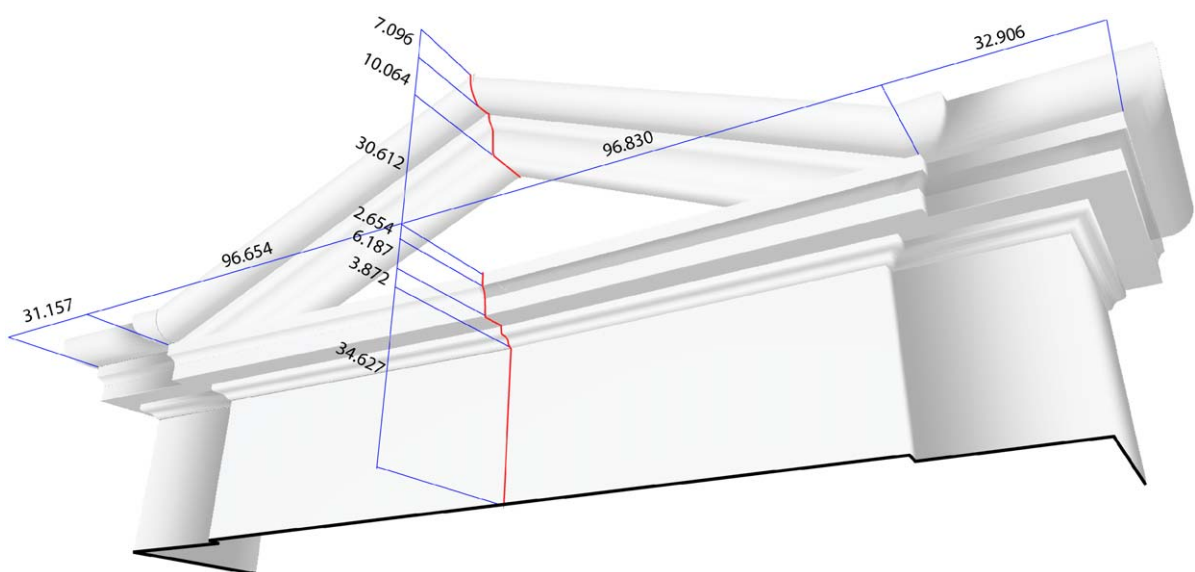

Fig. 16. Extraction of dimensions of the parts of the feature positioned on the point-cloud.



Fig. 17. The texture mapping process.

according to the associated knowledge and using appropriate geometrical representation and modeling tools. Currently, the digital model resulting from the reconstruction process described in this paper only concerns the morphology point of view.

Future works will introduce the concept of exploitation goal or of user point of view to drive the appropriate choices between various representations and level of details of a same object. The geometrical model associated with an architectural object of the digital mock-up will have to be able to support several representations (i.e. multi-representations) around the same semantic description. Appropriate tools will have to be set up to produce and manage these representations.

These various representations will be able to present information at different levels of consultation according to the user profiles (i.e. architect, historian, general public, etc.). Moreover, the geometrical model associated with an object will have to be able to take into account the temporal dimension of the building (i.e. its evolution during time). In this way, the conversion of the architectural models into geometrical ones can be considered as a data organization problem that exploits the communication with data bases. The required representations have to be identified according to the semantic complexity of a patrimony building. The global perspective is to constitute patrimonial data bases. Within the proposed framework, the 3D structured and enriched representation of patrimony buildings becomes a privileged support for navigation and interaction within the virtual edifices and its associated documentary sources (i.e. search and consultation of documents or information). Of course, these informa-

tion and documents sources will have to be associated with the 3D model in a structured way and according to different defined user point of views.

## Acknowledgments

We thank MENSİ and REALVIZ companies for their helpful comments and the following people for providing us images from their works: Francesca De Domenico (Fig. 1), Kyung-Tae Kim (Fig. 9). The CMN (French national center of patrimony buildings) is also acknowledged for the opportunity given to demonstrate our approach on the Hôtel de Sully in Paris. We thank Tudor Driscu for his help on the English translation.

## References

- [1] Barber D, Mills J, Bryan P. Laser scanning and photogrammetry: 21st century metrology. CIPA Symposium, Potsdam, Germany, 2001.
- [2] Debevec PE. Modeling and rendering architecture from photographs. PhD thesis, University of California, Berkeley, 1996.
- [3] Leibowitz D, Criminisi A, Zisserman A. Creating architectural models from images. In: Proceedings of eurographics 99, 1999.
- [4] Remondino F. From point cloud to surface: the modeling and visualization problem. In: Proceedings of ISPRS international workshop on visualization and animation of reality-based 3D models 03, 2003.
- [5] El-Hakim S, Beraldin A, Picard M. Detailed 3D reconstruction of monuments using multiple techniques. In: Proceedings of ISPRS workshop on scanning for cultural heritage recording 02, 2002.
- [6] Blaise JY, De Luca L, Florenzano M. Architectural surveying—from a point cloud to a 3D model. In: Proceedings of EVA-electronic visual arts 04, 2004.
- [7] Migliari R. Per una teoria del rilievo. Website: [www.rap-presentazione.net](http://www.rap-presentazione.net), 2001.
- [8] Faugeras O, Robert L, Laveau S, Csurka G, Zeller C, Gauclin C, et al. 3D reconstruction of urban scenes from image sequences. Computer Vision and Image Understanding 1998;69(3):292–309.
- [9] Pollefeys M, Koch R, Van Gool L. Self-calibration and metric reconstruction in spite of varying and unknown intrinsic camera parameters. International Journal of Computer Vision 1999;32(1):7–25.
- [10] Goulette F. Modélisation 3D automatique, outils de géométrie différentielle. Paris: Les presses de l'Ecole des Mines; 1999.
- [11] Curless B, Levoy M. A volumetric method for building complex models from range images. In: Proceedings of SIGGRAPH 96, 1996.
- [12] Docci M, Migliari R. Geometria e Architettura. Roma: Gangemi editore; 2000.
- [13] Tzonis A, Lefavre L. Classical architecture—the poetics of order. Cambridge: MIT Press; 1986.

- [14] Palladio A. *The four books of architecture*. New York: Dover publications; 1965 (original edition: Venezia, 1570).
- [15] Lichtenstein J. *La couleur éloquente*. Paris: Flammarion; 1989.
- [16] Rattner D. *Parallel of the classical orders of architecture*. New York: Acanthus Press; 1998.
- [17] Wittkower R. *Architectural principles in the age of humanism*. Chichester: Wiley; 1998.
- [18] Bernardini F, Rushmeier H, Martin IM, Mittleman J, Taubin G. Building a digital model of Michelangelo's Florentine Pieta. *IEEE CG & A* 2002;22(1):59–67.
- [19] Sequeira V, Wolfart E, Bovio E, Biotti E, Goncalves J. Hybrid 3D reconstruction and image-based rendering techniques for reality modeling. *SPIE* 2001;4309: 126–36.
- [21] Dekeyser F, Gaspard F, De Luca L, Florenzano M, Chen X, Leray P. Cultural heritage recording with laser scanning, computer vision and exploitation of architectural rules. In: *Proceedings of ISPRS conference: vision techniques for digital architectural and archaeological archives* 03; 2003.
- [22] Hartley R, Zisserman A. *Multiple view geometry in computer vision*. Cambridge: Cambridge University Press; 2004.
- [23] Tsai RY. An efficient and accurate camera calibration technique for 3D machine vision. In: *Proceedings of IEEE conference on computer vision and pattern recognition* 86, 1986.
- [24] Gould D. *Complete maya programming: an extensive guide to MEL and C++ API*. Los Altos, CA: Morgan Kaufmann, Paperback, 2002.
- [25] Véron P, Léon JC. Static polyhedron simplification using an error measurement criterion. *Computer-Aided Design* 1997;29(4):287–98.
- [26] Véron P, Léon JC. Shape preserving polyhedral simplification with bounded error. *Computer and Graphics* 1998;22(5): 565–85.

### Further reading

- [20] Trevisan C. Proporzioni e vera forma di particolari architettonici rilevati con scanner 3D: caratteristiche di un software specifico. *Disegnare idee immagini* 2002(24):44–9.