



Science Arts & Métiers (SAM)

is an open access repository that collects the work of Arts et Métiers Institute of Technology researchers and makes it freely available over the web where possible.

This is an author-deposited version published in: <https://sam.ensam.eu>
Handle ID: <http://hdl.handle.net/10985/8698>

To cite this version :

Lisi ZHU, Jingang HAN, Dongkai PENG, Tianzhen WANG, Tianhao TANG, Jean-Frederic CHARPENTIER - Fuzzy logic based energy management strategy for a fuel cell/battery/ultra-capacitor hybrid ship - In: 2014 International Conference on Green Energy, Tunisia, 2014-03 - 2014 International Conference on Green Energy - 2014

Any correspondence concerning this service should be sent to the repository

Administrator : scienceouverte@ensam.eu



Fuzzy logic based energy management strategy for a fuel cell/battery/ultra-capacitor hybrid ship

Lisi Zhu, Jingang Han, Dongkai Peng, Tianzhen Wang,
Tianhao Tang
Department of Electrical Engineering and Automation
Shanghai Maritime University
Shanghai, China
jghan.cn@gmail.com

Jean-Frederic Charpentier
French Naval Academy Research Institute
French Naval Academy
Brest, France
jean-frederic.charpentier@ecole-navale.fr

Abstract—In this paper, energy management strategy based on fuzzy logic is proposed for a fuel cell hybrid ship, combining proton exchange membrane fuel cell (PEMFC), battery and ultra-capacitor (UC). This hybrid system aims to optimize power distribution among each energy unit. The simulation model of the fuel cell hybrid power system is established in the MATLAB/SIMULINK simulation environment. The fuzzy logic energy strategy is verified by simulation according to the typical drive cycle of ship. The simulation results show that the proposed energy management strategy is able to satisfy power required by the ship, reduce the dynamic load of fuel cell, maintain the state of charge (SOC) of battery and SOC of the UC, and optimize the performance, fuel economy and efficiency of the hybrid system.

Keywords—fuel cell; hybrid power system; fuzzy logic; energy management strategy

I. INTRODUCTION

A fuel cell can directly convert chemical energy from chemical fuel into electrical energy without mechanical processes [1]. It is different from rechargeable batteries in that it can produce power continuously, as long as fuel and oxidant are supplied [2]. PEMFCs have been successfully demonstrated in various applications due to its outstanding advantages such as low operating temperature, quick start-up, high efficiency, zero emission, low noise and long life [3]. But fuel cell systems have some disadvantages, such as high cost, and slow response. Normally, a fuel cell hybrid system comprises an energy storage system (ESS) to improve dynamic performance of overall system and reduce the fuel cell cost. Battery and UC are suitable choices for energy storage system. Consequently, many recent works have already reported some hybrid power system structures using this kind of apparatus. Hwang et al. [4] and Barreras et al. [5] developed a hybrid powered electric vehicle in which the power system consisted of a PEMFC and batteries. Paladini et al. [6] focused on a car with a hybrid power train based on a PEMFC, UC and battery. Caux et al. [7] describes a hybrid system powered by a fuel cell with UC. Bauman et al. [8] compared three configurations for a vehicle: PEMFC/battery, PEMFC/UC and PEMFC/battery/UC. Battery presents relatively high energy density. Compared with battery, UC generally has a higher specific power density, it is more efficient, and has a longer life time [9]. However, the energy density of UC is significantly lower than battery system. Thus,

an hybrid ESS with batteries and UC can combine the high energy density of battery with the high power density of UC.

To split power between the fuel cell system and the different apparatus of the ESS, energy management strategy is needed. Recently, many research works in the power management strategy of hybrid systems have been done. The work of Xie et al. [10], Zheng et al. [11], and Xu et al. [12] described an off-line global optimal control strategy based on an equivalent consumption minimization strategy. However, global optimization strategy often requires a priori knowledge of a scheduled driving cycle, and it is too difficult for real-time application [13, 14]. Xu et al. [15] proposed a real-time optimal energy management strategy based on the determined dynamic programming strategy. Bernard et al. [16] described a real-time optimization strategy based on instantaneous optimization. But large amount of online computation of real-time optimization limits its promotion [17]. Fuzzy logic strategy is suitable for complex nonlinear system with several variables, and it is strong practical and promising for its robust and good real-time performance. This can be seen in the works of Gao et al. [18], Erdinc et al. [19], and Thounthong et al. [20].

To test the proposed configuration and management strategy, a realistic specification set is used. These specifications are based on the data of the Fuel Cell Ship (FCS) “Alsterwasser”. This passenger ship driven by fuel cells, was manufactured by Proton Power System Company in Germany. In this paper, a PEMFC /UC/battery hybrid power system is proposed as the propulsion power system of FCS “Alsterwasser” and a fuzzy logic management was used to manage the power distribution between the PEMFC, UC and battery.

To validate the energy management strategy, we have established the model of the fuel cell hybrid power system in the MATLAB/SIMULINK simulation environment. The powertrain structure was firstly described in Section 2. Models used in simulation are described in Section 3. In Section 4, the proposed power management strategy is introduced and implemented according to the typical drive cycle of ship. In Section 5, the simulation results are presented and discussed..

II. SYSTEM CONFIGURATION

The configuration of the power train of the FCS is shown in Fig. 1. The hybrid power train consists of a fuel cell system, a UC pack, a battery pack, a propulsion system, a bidirectional DC/DC converter and a unidirectional DC/DC converter. The fuel cell system supplies the power to the load (and ESS) through the unidirectional DC/DC converter, the UC pack is connected to the DC bus via the bidirectional DC/DC converter and the battery pack is connected directly to the DC bus. Table I summarizes the specifications of this fuel cell hybrid system.

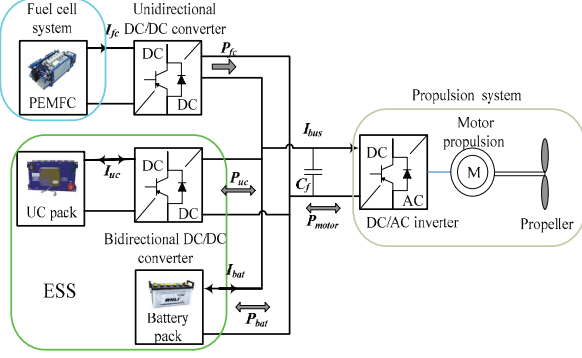

Fig. 1. Configuration of the fuel cell hybrid system.

TABLE I. SPECIFICATIONS OF FUEL CELL HYBRID SYSTEM

Power Components	Parameter	Value
Fuel cell system	Type	PEMFC
	Output voltage	140V-260V
	Nominal output power	96kW
	No. of modules	490
Battery	Type	Lead-acid
	Capacity	60Ah
	No. of modules	7
	Nominal voltage	560V
Ultra-capacitor	Capacity	128F
	Maximum voltage	405V
Unidirectional DC/DC	Type	Boost
	Input voltage	100-300V
	Output voltage	400-700V
Bidirectional DC/DC	Type	Boost-Buck
	Input voltage	200-400V
	Output voltage	400-700V

III. MODELLING OF THE HYBRID SYSTEM

A. Fuel cell system model

The parameters used in the FC model are shown in Table II. The actual fuel cell potential is lower than the ideal potential value due to the irreversible voltage drops occurring in fuel cell systems. Activation overvoltage and ohmic overvoltage are the two main types of irreversible voltage drops. The output voltage of fuel cell can be obtained from the sum of Nernst instantaneous voltage, activation overvoltage, and ohmic overvoltage [10].

$$V_{fc} = E_{Nernst} + \eta_{act} + \eta_{ohmic} \quad (1)$$

Nernst instantaneous voltage, activation overvoltage and ohmic overvoltage could be expressed as:

$$E_{Nernst} = N[E_o + \frac{RT}{2F} (\frac{P_{H_2} \sqrt{P_{O_2}}}{P_{H_2O}})] \quad (2)$$

$$\eta_{act} = -B \ln(CI_{fc}) \quad (3)$$

$$\eta_{ohmic} = -I_{fc} R_{int} \quad (4)$$

The output voltage of the FC stack could be fundamentally expressed as:

$$V_{fc} = N[E_o + \frac{RT}{2F} (\frac{P_{H_2} \sqrt{P_{O_2}}}{P_{H_2O}})] - B \ln(CI_{fc}) - I_{fc} R_{int} \quad (5)$$

The relationships between the fuel cell current and the fuel cell voltage and power are shown in Fig. 2.

TABLE II. FUEL CELL SYSTEM PRAMETERS

Symbol	Parameter	Symbol	Parameter
$B \& C$	Constant utilized in modeling of activation overvoltage (V)	R_{int}	Fuel cell internal resistance (Ω)
I_{fc}	FC current (A)	V_{fc}	Fuel cell voltage (V)
R	Universal gas constant (J/(kmol·K))	N	Number of FC stacks
T	Absolute temperature (K)	C_p	Constant-pressure specific heat capacity of air (J/(kmol·K))
F	Faraday constant (C/kmol)	γ	Ratio of the specific heats of air
E_o	Standard no load voltage (V)	P_{sm}	Pressure inside the supply manifold
P_{H_2}	Hydrogen partial pressure (atm)	T_{atm}	Atmospheric temperature (K)
P_{H_2O}	Water partial pressure (atm)	P_{atm}	Atmospheric pressure (atm)
P_{O_2}	Oxygen partial pressure (atm)	η_{cp}	Atompresor efficiency (atm)
η_{ohmic}	Ohmic over voltage (V)	W_{cp}	Mass flow rate (kg/s)
η_{act}	Activation overvoltage (V)	E_{Nernst}	Nernst instantaneous voltage (V)

Power consumption of the auxiliary components of the fuel cell system should not be ignored. As the compressor power is up to 93.5% of the total auxiliary power consumption [21], only the power absorbed by the compressor is taken into account in this work.

The power consumption of the compressor can be calculated as [25]:

$$P_{cp} = \frac{C_p \cdot T_{atm} \cdot W_{cp}}{\eta_{cp}} \left[\left(\frac{P_{sm}}{P_{atm}} \right)^{(\gamma-1)/\gamma} - 1 \right] \quad (6)$$

Thus, the output power of the fuel cell system is denoted as:

$$P_{fcs} = P_{fc} - P_{cp} \quad (7)$$

Here, P_{fc} represents the output power of fuel cell stacks. The output efficiency of the fuel cell system could be expressed as:

$$\eta_{fcs_out} = \frac{P_{fcs}}{P_{fc}} = \frac{P_{fc} - P_{cp}}{P_{fc}} \quad (8)$$

The energy conversion efficiency of the fuel cell stacks is formulated as [26]:

$$\eta_{fc} = \frac{V_{fc}}{1.482 \cdot N} \quad (9)$$

Finally, the total fuel cell system efficiency is as follow:

$$\eta_{fc} = \eta_{fc} \eta_{fcs_out} \quad (10)$$

In Fig. 3 fuel cell energy conversion and system efficiency curves are plotted against the power produced by the fuel cell. To minimize fuel consumption, the fuel cell system should be avoided to operate in the poor efficiency region.

B. Battery model

Fig. 4 shows the typical model of a battery with internal resistance. In the model, a battery is equivalent to a voltage source and an internal resistor [22,23]. Where U_o is the no load voltage; I_{bat} is the battery current; R_{bat} is the internal resistance and U_{bat} is the battery voltage.

The SOC change rate and current of the battery are expressed by the following equations:

$$I_{bat} = \frac{U_o - \sqrt{U_o^2 - 4R_{bat}P_{bat}}}{2R_{bat}} \quad (11)$$

$$SOC = -\frac{I_{bat}}{Q_{bat}} \quad (12)$$

C. Ultra-capacitor model

The natural structure of UC is appropriate to meet transient and instantaneous peak power demands [19,24]. Many

different models have been proposed for UC. The classical equivalent circuit of UC is shown in Fig. 5. Where C_{uc} is the capacitance; I_{uc} is the UC current; R_{ESR} is the equivalent series resistance (ESR) and V_{uc} is the no load voltage.

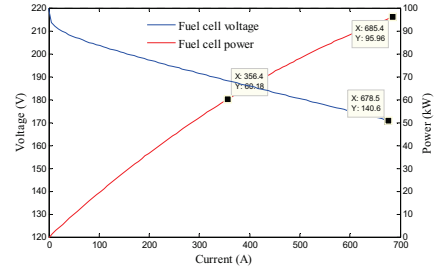

Fig. 2. Fuel cell voltage and power.

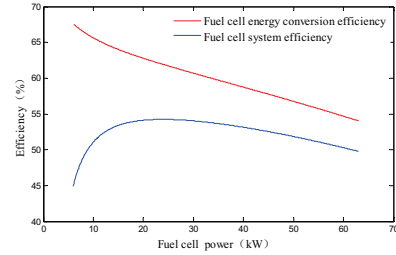

Fig. 3. Fuel cell energy conversion and system efficiency.

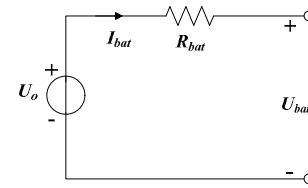

Fig. 4. Internal resistance battery model.

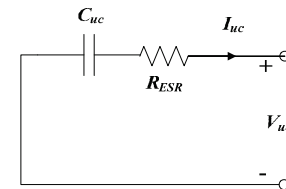

Fig. 5. Classical equivalent circuit for UC.

D. Used Driving Cycle

In this work typical small pleasure boat specifications are used. These specifications corresponds to the FCS of the “Alsterwasser” which is located on Lake Alster in Hamburg, Germany. To validate the proposed energy management, a typical driving cycle on Lake Alster is selected as a reference cycle to simulate the route test for the fuel cell hybrid powertrain. It is characterized by acceleration, constant speed and deceleration steps and lasts about 360s[27]. The maximum power is 112kW and the average power is 43.6kW.

IV. FUZZY LOGIC ENERGY MANAGEMENT STRATEGY

The power management strategy should determine the split of power between the fuel cell stack and ESS while satisfying the load power requirement and maintaining the SOC of battery and the SOC of the UC within a reasonable range. The power distribution of power among the fuel cell system and UC pack is determined by taking account of the required power of the motor and SOC s of the battery and UC. The power required from the battery can be obtained by subtracting the power required from the fuel cell system and the UC from the power required by the motor.

The fuzzy logic controller in this study has three input variables : SOC of battery (SOC_{bat}), SOC of UC (SOC_{uc}) and the required power of motor (P_{motor}) and two output variables : the required power of fuel cell system (P_{re_fcs}) and UC pack (P_{re_uc}) power. The fuzzy controller relates its outputs to inputs using a list of IF-THEN rules. The IF part of a rule, called the antecedent, specify the condition for which a rule holds. The THEN part, called the consequent, refers to values of the output variable [18]. The membership degree of the IF part of all rules are evaluated and all rules of the THEN part are averaged and weighted by these membership degrees [9]. Triangular and trapezoidal membership functions are chosen for the fuzzy inputs and outputs, as shown in Fig.6 and Fig. 7. There are five membership functions for inputs and P_{re_fcs} , including VS (Very Small), S (Small), M (Medium), B (Big), and VB (Very Big). The linguistic terms for P_{re_uc} are: NB (Negative Big), NS (Negative Small), ZE (Zero), PS (Positive Small) and PB (Positive Big).

To promote the overall system efficiency and the lifetime of fuel cell, the fuel cell power output value of the EMS is limited in a reasonable and relatively high efficiency region. In one hand, the equivalent internal resistance of UC is very low, thus very high discharging/charging currents are possible with very low losses. This is why the use of the UC bank does not affect efficiency. In other hand, due to high power capability and rapid response capability of UC, the transient components of load profile can be easily and efficiently supplied by UC.

When the ship is accelerating and the load power demand is high, the fuel cell system, the battery and the UC should supply power to the ship simultaneously. UC should response for quick load changes and provide transient power peaks. When the ship is driving at a constant speed and the required power is stable, the distribution of power among the three power sources is complex, and depends on the battery SOC and the UC SOC . If the SOC_{bat} and SOC_{uc} are lower than the desired level, fuel cell will supply the load and also charge UC and battery, if the SOC_{bat} and SOC_{uc} are higher than the desired level, the UC and battery will discharge to supply a part of the required load power. If the SOC s of UC and battery are around the desired level, fuel cell supplies all the demand power. When the ship is decelerating and the load power demand is very low, if the SOC_{bat} and SOC_{uc} is less than the desired value, the fuel cell system delivers more power in order to increase the SOC s of the UC and battery. If the SOC_{bat} and SOC_{uc} are higher than the desired level, the UC and

battery will supply the entire required power. If both SOC values are near the desired value, fuel cell supplies all the demand power. SOC_{bat} and SOC_{uc} should be controlled in a suitable region to ensure that battery and UC have enough charge to supply the required power when the ship is accelerating. It is rather important for decreasing the fuel consumption and increasing fuel economy. Table III and Table IV show the IF-THEN rules of the fuzzy logic controller which corresponds to the previous assumptions. For example, if P_{motor} is “S” , SOC_{bat} is “S” and SOC_{uc} is “S” , P_{re_fcs} is “VB” , and P_{re_uc} is “PS” .

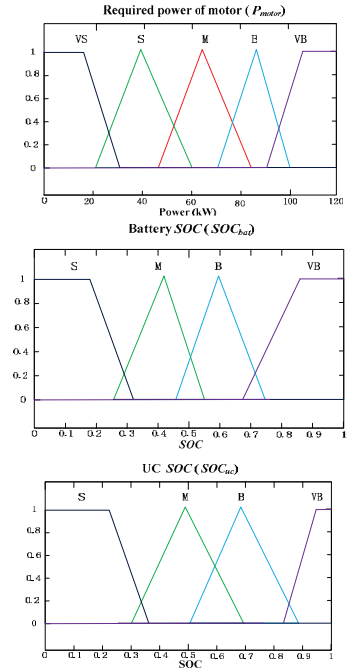

Fig. 6. Membership functions of the inputs.

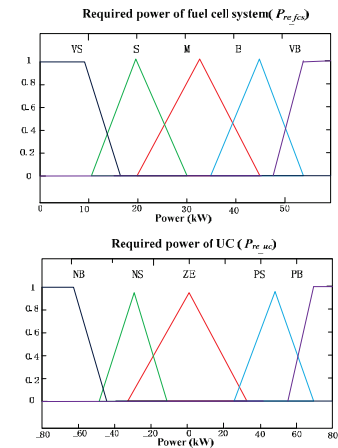

Fig. 7. Membership functions of the outputs.

V. SIMULATION RESULTS AND DISCUSSION

Simulation model of the fuel cell system of FCS “Alsterwasser” has been built in MATLAB/SIMULINK

environment. The proposed energy management strategy has been tested for the typical drive cycle of FCS “Alsterwasser”. The simulation results are given in Fig. 8-11, respectively.

TABLE III. FUZZY LOGIC IF-THEN RULES (I)

Required power of fuel cell system (P_{re_fcs})					
P_{motor}	SOC_{uc}	S	M	B	VB
	SOC_{bat}	S	M	B	VB
S	S	VB	VB	VB	VB
	M	VB	VB	VB	B
	B	VB	VB	VB	B
	VB	VB	B	B	S
B	S	VB	VB	VB	VB
	M	VB	B	B	B
	B	VB	VB	VB	B
	VB	VB	VB	B	S
M	S	VB	VB	VB	B
	M	VB	B	B	B
	B	VB	B	B	B
	VB	VB	B	M	VS
S	S	VB	VB	VB	B
	M	VB	VB	VB	B
	B	VB	VB	B	B
	VB	B	B	VS	M
VS	S	VB	VB	B	B
	M	B	B	B	B
	B	B	B	B	S
	VB	M	M	VS	VS

TABLE IV. FUZZY LOGIC IF-THEN RULES (II)

Required power of UC (P_{re_uc})					
P_{motor}	SOC_{uc}	S	M	B	VB
	SOC_{bat}	S	M	B	VB
S	S	PS	PS	PS	PS
	M	PB	PS	PS	PS
	B	PB	PB	PB	PS
	VB	PB	PB	PB	PB
B	S	PS	ZE	ZE	ZE
	M	PS	PS	PS	PS
	B	PB	PB	PS	PS
	VB	PB	PB	PS	PS
M	S	ZE	ZE	ZE	ZE
	M	PS	ZE	ZE	ZE
	B	PS	ZE	ZE	ZE
	VB	PS	PS	PS	PS
S	S	ZE	NS	NS	NS
	M	ZE	ZE	NS	NS
	B	ZE	ZE	ZE	ZE
	VB	PS	PS	PS	ZE
VS	S	NS	NB	NB	NB
	M	ZE	NS	NB	NB
	B	ZE	NS	NS	NS
	VB	ZE	ZE	ZE	ZE

Fig. 8 illustrates the fuel cell system output power and Fig. 9 shows the output power of battery and UC. As seen in Fig. 8-9, the simulation results show good distribution of power among the fuel cell system, the battery and the UC. It is obvious that FCS satisfies the rated power demand without facing to transient changes. The battery & UC supply power to the load simultaneously for the slow response of fuel cell

system. The output power of the fuel cell system is maintained mainly between 30 kW and 50kW. It is a good way to extend the fuel cell lifetime by keeping fuel cell supplying the steady state load demand. This behavior leads to less fuel cell stress.

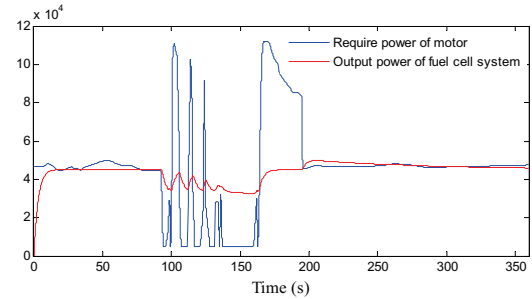

Fig. 8. Required power of motor and fuel cell system output power.

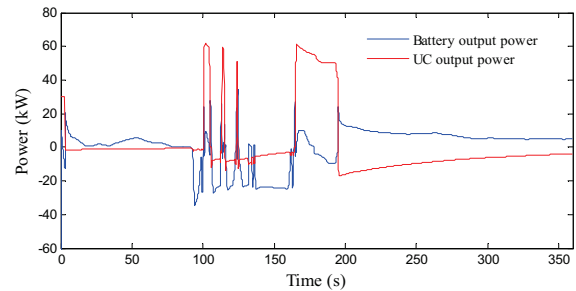

Fig. 9. Battery and UC output power.

In Fig. 10, it can be seen that the $SOCs$ of the battery and UC can be maintained within suitable limits. The SOC of the battery is regulated near its initial SOC value of 60% successfully. The SOC of UC fluctuates between 0.5 and 0.7. The proposed EMS ensures that UC and battery has always enough charge for the accelerating periods. Thus, both battery and UC bank can effectively supply the required load demand and fuel economy can be promoted.

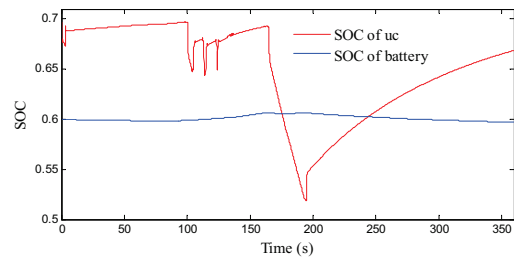

Fig. 10. $SOCs$ of the battery and UC.

Fig. 11 shows the operating region of the fuel cell system. It could be seen that the output power of the fuel cell system is in a relatively high-efficiency region during the 360s driving cycle. It is quite important for the overall system efficiency.

The hydrogen consumption during the drive cycle is 1374.2g. The global energy efficiency is given by:

$$\eta_{total} = \frac{P_{motor}}{P_{fc_in} + P_{ba_in} + P_{uc_in}} \eta_{fcs_out} \quad (14)$$

Where P_{fc_in} , P_{ba_in} and P_{uc_in} are the fuel cell input power, battery input power and UC input power, respectively. The global energy efficiency with the proposed energy management strategy is calculated as 51.4%.

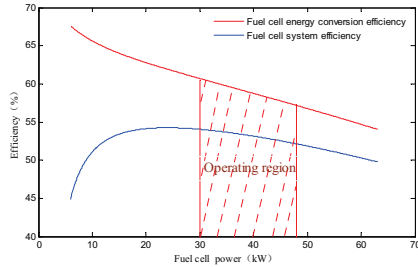

Fig. 11. Operating region of the fuel cell system.

VI. CONCLUSION

In this paper, we have presented a fuel cell/battery/UC hybrid powertrain of a ship which is based on the real specifications of a small pleasure boat. Because of the complexity of the power train, a fuzzy logic controller has been developed to manage the hybrid power energy system. To evaluate the performance of the proposed energy management strategy, a test has been carried out on a typical driving cycle of the studied boat which works in Lake Alster in Germany. The results show that the operation efficiency and performance of the hybrid system was improved and SOC's of the battery and UC are maintained at reasonable level.

ACKNOWLEDGMENT

The research is supported by the program of the National Natural Science Foundation (No.61304186 and No.51007056).

REFERENCES

- [1] Correa J, Farret F, Canha L, and Simoes M, "An electrochemical-based fuel-cell model suitable for electrical engineering automation approach," IEEE Trans. Ind. Electron., vol. 51, no.11, pp. 3-11, 2004.
- [2] Haiping Xu, Li Kong, and Xuhui Wen, "Fuel Cell Power System and High Power DC-DC Converter," IEEE Trans. Po. Electron., vol. 19, no. 5, pp. 1250-1255, 2004.
- [3] Yong Tang, Wei Yuan, Minqiang Pan, and Zhenping Wan, "Experimental investigation on the dynamic performance of a hybrid PEM fuelcell/battery system for lightweight electric vehicle application," J. Applied Energy, vol. 88, pp. 68-67, 2011.
- [4] Hwang JJ and Chang WR, "Characteristic study on fuel cell/battery hybrid power system on a light electric vehicle," J. Power Sources, vol. 207, no. 11, pp. 1-9, 2012.
- [5] Barreras F, et al, "Design and development of a multipurpose utility AWD electric vehicle with a hybrid powertrain based on PEM fuel cells and batteries," J. Hydrogen Energy, vol. 37, no. 153, pp. 67-79, 2012.
- [6] V. Paladini, T. Donato, A. de Risi, and D. Laforgia, "Super-capacitors fuel-cell hybrid electric vehicle optimization and control strategy development," J. Energy Conversion and Management, vol. 48, no. 11, pp. 3001-3008, 2007.

- [7] Caux S, Lachaize J, Fadel M, Shott P, and Nicod L, "Modelling and control of a fuel cell system and storage elements in transport applications," J. Process Control, vol. 15, no. 4, pp. 81-91, 2005.
- [8] Bauman J and Kazerani M. "A comparative study of fuel cell-battery, fuel cell-ultracapacitor, and fuel cell-battery-ultracapacitor vehicles," IEEE Trans. Veh. Technol., vol. 57, no.2, pp. 760-769, 2008.
- [9] J. Jia and Y. Wang, "The advanced control and its experiments of a hybrid PEMFC and ultra-capacitor system," in Proc. 9th ICCA, Santiago, Chile, Dec. 2011.
- [10] Changjun Xie, Joan M. Ogden, Shuhai Quan, and Qihong Chen, "Optimal power management for fuel cell-battery full hybrid powertrain on a test station," J. Electrical Power and Energy Systems, vol. 53, pp. 307-320, 2013.
- [11] C.H. Zheng, C.E. Oh, Y.I. Park, and S.W. Cha, "Fuel economy evaluation of fuel cell hybrid vehicles based on equivalent fuel consumption," J. Hydrogen Energy, vol. 37, pp. 1790-1796, 2012.
- [12] Xu L, Li J, Hua J, Li X, and Ouyang M, "Optimal vehicle control strategy of a fuel cell/battery hybrid city bus," J. Hydrogen Energy, vol. 34, no.73, pp. 23-33, 2009.
- [13] Delprat S, Lauber J, Guerra T, and Rimaux J, "Control of a parallel hybrid powertrain: optimal control," IEEE Trans. Veh. Technol., vol. 53, no.3, pp. 872-881, 2004.
- [14] Lin C, Peng H, Grizzle J, and Kang J, "Power management strategy for a parallel hybrid electric truck," IEEE Trans. Control. Syst. Technol., vol. 11, no.6, pp. 839-849, 2003.
- [15] Xu Liangfei, Yang Fuyuan, Li Jianqiu, Ouyang Minggao, and Hua Jianfeng, "Real time optimal energy management strategy targeting at minimizing daily operation cost for a plug-in fuel cell city bus," J. Hydrogen Energy, vol. 37, no.153, pp. 80-92, 2012.
- [16] J. Bernard, S. Delprat, T.M. Guerra, F.N. Büchi, "Fuel efficient power management strategy for fuel cell hybrid powertrains," J. Control Engineering Practice, vol. 18, pp. 408-417, 2010.
- [17] Li Yufang, Zhao Youqun, and Yang Zhenglin, "Study on Power Distribution Strategy and Optimization of Fuel Cell Hybrid Vehicles," in Proc. 8th VPPC, Harbin, China, Sept. 2008.
- [18] Gao Dawei, Jin Zhenhua, and Lu Qingchun, "Energy management strategy based on fuzzy logic for a fuel cell hybrid bus," J. Power Sources, vol. 185, pp. 311-317, 2008.
- [19] O. Erdinc, B. Vural, and M. Uzunoglu, "A wavelet-fuzzy logic based energy management strategy for a fuel cell/battery/ultra-capacitor hybrid vehicular power system," J. Power Sources, vol. 194, pp. 369-380, 2009.
- [20] P. Thounthong, S. Sikkabut, A. Luksanasakul, P. Koseeyaporn, and P. Sethakul, "Fuzzy logic based DC bus voltage control of a stand alone photovoltaic/fuel cell/supercapacitor power plant," in Proc. 11th IEEEIC, Venice, Italy, pp. 725-730, May 2012.
- [21] Boettner DD, Paganelli G, Guezennec YG, Rizzoni G, and Moran MJ, "Proton exchange membrane fuel cell system model for automotive vehicle simulation and control," J. Energy Resour. Technol. Trans. ASME, vol. 124, pp. 20-27, 2002.
- [22] Chunyan Li and Guoping Liu, "Optimal fuzzy power control and management of fuel cell/battery hybrid vehicles," J. Power Sources, vol. 192, pp. 525-533, 2009.
- [23] R. L. Spyker and R. M. Nelms, "Analysis of double-layer capacitors supplying constant power loads," IEEE Trans. Aerosp. Electron. Syst., vol. 36, no. 4, pp. 1439-1443, Oct. 2000.
- [24] Kim NW, Lee DH, Cha SW, and Peng H, "Optimal control of a plugin hybrid electric vehicle (PHEV) based on driving patterns," in Proc. EVS24, Stavanger, Norway, Jun. 2009.
- [25] Pukrushpan JT, Peng H, and Stefanopoulou AG. "Control-oriented modeling and analysis for automotive fuel cell systems," J. Dyn. Syst. Meas. Control, vol. 126, pp. 14-25, 2004.
- [26] Caux S, Hankache W, Fadel M, and Hissel D, "On-line fuzzy energy management for hybrid fuel cell systems," J. Hydrogen Energy, vol. 35, pp. 2134-2143, 2010.
- [27] Anno Mertens. The Zemships Propulsion System and beyond. Zemships conference. H2 Expo, Hamburg, 22 October 2008.