



Science Arts & Métiers (SAM)

is an open access repository that collects the work of Arts et Métiers Institute of Technology researchers and makes it freely available over the web where possible.

This is an author-deposited version published in: <https://sam.ensam.eu>
Handle ID: <http://hdl.handle.net/10985/11409>

To cite this version :

Katia LUPINETTI, Franca GIANNINI, Marina MONTI, Jean-Philippe PERNOT - CAD assembly descriptors for knowledge capitalization and model retrieval - In: Tools and Methods for Competitive Engineering (Aix-en-Provence : 16 : 2016), France, 2016 - Proceeding of Tools and Methods for Competitive Engineering - 2016

Any correspondence concerning this service should be sent to the repository

Administrator : scienceouverte@ensam.eu



CAD ASSEMBLY DESCRIPTORS FOR KNOWLEDGE CAPITALIZATION AND MODEL RETRIEVAL

Katia Lupinetti^{1,2}

¹Istituto di Matematica Applicata e Tecnologie Informatiche "E. Magenes"

¹Consiglio Nazionale delle Ricerche

²Arts et Métiers ParisTech

LSIS Laboratory

katia.lupinetti@ge.imati.cnr.it

Franca Giannini¹

Marina Monti¹

¹Istituto di Matematica Applicata e Tecnologie Informatiche "E. Magenes"

¹Consiglio Nazionale delle Ricerche

franca.giannini@ge.imati.cnr.it

marina.monti@ge.imati.cnr.it

Jean-Philippe Pernot²

²Arts et Métiers ParisTech

LSIS Laboratory

jean-philippe.pernot@ensam.eu

1. ABSTRACT

Today, there exists a huge amount of digital data easily downloadable from Internet and/or simply accessible from large databases. Despite this rise, the methods to retrieve and search for specific data have not been sufficiently studied and developed, notably when considering 3D contents. Thus, it is sometime more efficient to define new 3D shapes starting from scratch rather than to try to make use of existing ones hardly identifiable within those databases. This is particularly true when considering CAD assembly models often resulting from a long and time-consuming modeling phase within the Product Development Process. Thus, having new methods, models and tools to capitalize, retrieve and reuse CAD assembly models would help saving a lot of time. This paper addresses such a difficult problem of finding a method to characterize and structure CAD assemblies so as to be able to search for similar ones. A framework has been designed for the retrieval of globally and/or partially similar assembly models according to different user-specified search criteria. It is based on an assembly descriptor, called the Enriched Assembly Model (EAM), which encodes all the required data automatically extracted from the geometry and structure of the CAD models. The data are organized in several layers thus enabling multi-level structuring and queries. It also allows fuzzy queries, which can be further refined.

KEYWORDS

Assembly representation, assembly retrieval, multi-layered search, multi-modal descriptors.

2. INTRODUCTION

CAD models have become mainstream in many industrial applications. They can be considered as digital product reference models stored within a Digital Mock-Up used and shared all along the Product Development Process [6]. Over the last few years, CAD model databases grew up so much that it has become challenging to develop new searching and browsing methods and tools. This is notably true for what concern the structuring, the access and the reuse of those databases. Actually, being able to reuse existing information and data, including existing 3D models, became a crucial factor for the competitiveness of the industries whose behavior is often driven by the well-known triptych cost-quality-delay. Being faster in developing or releasing new products is a key issue.

During the design process of a new product, the ability to retrieve existing models, either parts or assemblies, can be useful to reach several objectives as reusing an existing assembly in new configurations, or providing access to existing design knowledge (e.g. simulation results, manufacturing phases) related to similar products [8] or to identify similar configurations that could benefit from a standardization. However, such a retrieval process is not straightforward when considering CAD models potentially

made of several hundreds of thousands of parts. Thus, specific search techniques have to be developed and optimized to be able to retrieve elements in a reasonable time.

In simple text-based retrievals, the user types a list of words or sentences that he/she wants to search in the database. However, with this technique, some models are not retrieved, even if they are semantically related with the query since they have not the same text in their annotations. These limitations may be overcome by using search methods based on thesauri, i.e. collections of controlled vocabulary terms that use associative relationships. However, these techniques are not sufficient since annotations may not be present and there is no guarantee of compliance to name conventions; moreover, they do not consider the shapes of the parts.

Anyhow, in case of complex products made of several parts a method based only on the shape is not sufficient for retrieving the target assembly model. Actually, 3D models with similar shapes can be assembled in different ways, involving different kinematic characteristics and then different relationships between their parts. For example, an assembly of two parts with 5 screws can be considered similar to the same assembly with 6 screws. In this case, at a higher level, what is important is that the two parts have been screwed whatever the number of screws. Thus, an advanced search method has to incorporate mechanisms working at different levels (e.g. geometry, kinematic, annotation).

For the effective re-use of existing models, content-based methods should also allow queries without the specification of a CAD model as input. This possibility is particularly important since at the early design stage, the designer would be interested in expressing vague queries, e.g. simply by specifying some attributes of the assembly model, just to take inspiration from the available models. Therefore, the challenge is to find an assembly representation able to support user requests at different level of specification details but also that is automatically defined. Indeed, to require the user to add manually some information may represent a heavy limitation.

In this context, it is crucial to provide a tool for the retrieval of assembly models which can be tailored to the user needs, and thus, that is able to consider the assembly and the part shapes, the interlinks between sub-assemblies and parts and other aspects that are implicitly stored in the 3D data.

In this paper, we propose a framework for the re-

trieval of globally and/or partially similar assembly models according to different search criteria that can be convenient for designers. It is based on an assembly descriptor, called the Enriched Assembly Model (EAM), which encodes all the required data extracted by analyzing the geometry and structure of the CAD model without user intervention. It allows fuzzy queries, which can be further refined and applied on search results. Section 2 reviews the related works. The EAM model is introduced in section 3 and the complete framework in section 4. The last section ends this paper with some conclusions and perspectives.

3. RELATED WORKS

Gupta et al. have categorized the various use scenarios for content-based assembly search as follows [8]:

- Design reuse. The retrieving of an existing similar model allows the designer to make modifications to it and to obtain faster a new product.
- Accessing the related existing knowledge. The availability of information related to similar models (e.g. costs, reliability and failure reports, shape adaptation processes for simulation and analysis results) makes easier the evaluation of the new product solutions.

In addition to these use cases, one can also imagine having mechanisms to identify similar CAD models in order to be able to standardize parts or assemblies. In literature, a lot of works focuses on part retrieval. Tangelder and Veltkamp [16] and Iyer et al. [9] provide a complete state-of-the-art on 3D shape retrieval. However, these techniques focus on shape characteristics and do not take into account other important aspects for assembly models' similarity, such as the relationships between the parts and are not able to retrieve similar assembly structures or more simply a sub-assembly in another assembly.

There are various works addressing the analysis of assembly models for diverse objectives, such as the identification of assembly constraints or the assembly sequence planning; only a limited set of works directly addresses the search for assembly models similar to a given one.

To the purpose of our research, we identified some useful criteria for a comprehensive analysis of the works directly or indirectly addressing the identification of similarities in assembly models under different perspectives. The adopted criteria can be grouped into the following macro-categories:

- context,

- type of information exploited,
- type of assembly descriptors defined,
- query model.

The context includes the **work objectives** and the required **type of input** data (i.e. B-Rep, 3D mesh or point cloud). The type of information refers to the information (i.e. **geometric and/or topological information**) the authors use to characterize the assembly model. Either this information can be implicitly coded in the input data or it can be explicitly associated to it. Moreover, it specifies if **the assembly relationships** (i.e. the relationships between the assembly components) are explicit in the CAD native models, automatically derived from assembly geometry or specified by the user.

The type of assembly descriptors includes indications on the **assembly description level**, i.e. (i) assembly level: the assembly is described by its parts and/or their relationships; (ii) part level: the assembly is described by its parts; (iii) feature level: the assembly is described through shape portions having specific assembly meaning. Moreover, it indicates how the assembly descriptors are implemented, i.e. **the descriptor representation** used to store the information, such as graph or vector.

The **query model** indicates the type of data required to express the query (i.e. a single CAD assembly model, a set of CAD assembly models, a set of CAD part models such as a sub-assembly without the constraints, a 3D mesh, or an abstract assembly de-

Paper	Input model	Work objective	Geometric/topological information used	Assembly relationships	Assembly descriptor level	Descriptor representation	Query model
[20]	B-Rep	Search for frequent similar sub-assembly models	Curvature, Model components, Mating constraints	Already existing in the CAD model	Assembly Part	Face Adjacency Graph	Assembly model
[10]	3D mesh	Search for globally similar assembly models	Model components	none	Part	Component Vector	Assembly model
[3]	B-Rep	Search for globally or partially similar assembly models	Model elements Mating constraints Degree of freedom annotation	Partially extracted	Assembly Part	Hierarchical graph	Assembly model
[18]	B-Rep	Search for globally similar assembly models	Model elements Surface properties Contact relations	Manually inserted	Assembly Part	Component attributed relation graph	Assembly model
[12]	B-Rep	Search for globally similar assembly models	Shape characteristics Mating constraints	Already existing in the CAD model	Assembly Part	Attributed Assembly graph	Assembly model
[5]	B-Rep	Search for globally or partially similar assembly models	Model elements Mating constraints Degree of freedom Annotation	Already existing in the CAD model	Assembly Part	Mating graph	Set of statistics Mating graph

Table 1 Summary of works directly addressing assembly models' retrieval

scriptor).

Table 1 summarizes the analyzed works directly aimed at the retrieval of similar assembly models according to the above criteria. Among these works, only two adopt a more comprehensive approach [3, 5]. Deshmukh et al. take into account many different aspects that play a meaningful role in the description of an assembly product [5]. The main limit of the presented work is in the required availability of several important information (such as the component orientation, component relationships and the joint constraints). A global approach, which aims to overcome this limitation, is proposed by Chen et al. [3]. This work does not consider the overall assembly shape but focuses on the product structure and the relationships between the different parts of the assembly.

The assembly descriptor presented in this work takes into account different information levels. It includes topological structure, relationships between assembly components, and geometric information. It permits the use of rough and partial incomplete queries to allow a search completely adaptable to the designer requirements. The framework we propose is based on an assembly model that similarly to the ones presented in [3] and [5] is able to support user requests at different level of specification details but differently than [5] does not require the user to add manually some information. Differently than [3] the mapping algorithm is not limited to the identification of assembly models with the same structure in terms of sub-assemblies. Moreover, the framework does not rely on a specific CAD native file format, but requires as input a STEP file describing the assembly model, in which only geometric information is available and allows the retrieval of assembly models of which the query model is a sub-set.

4. THE ENRICHED ASSEMBLY MODEL

In order to allow an efficient and meaningful retrieval of CAD assembly models, a suitable description of the assembly should be provided. As previously described, an effective reuse of already existing models requires the possibility to perform search with queries using incomplete information and involving characteristics which might be not explicitly encoded in the CAD models, but highlighting features valuable for the search purposes. To this aim in the following, we propose a new shape descriptor called Enriched Assembly Model (EAM), which organizes information in a multi-layer structure aimed at guaranteeing the search flexibility. This permits search

queries involving one or several layers of information in various combinations. The considered layers are: structural layer, statistic layer, shape layer and interface assembly layer.

4.1. Structural layer

The structural layer of the EAM encodes the hierarchical assembly structure of the CAD model as specified by the designer. At this level, information is stored as a tree graph in which arcs indicate the relation part-of and nodes correspond to the assembly elements. In particular, leaves represent the parts of the assembly model, the root the entire assembly model, while intermediate nodes represent sub-assemblies of the original model. Attributes are associated to leaf nodes to indicate the type of the corresponding component: *fastener* (e.g. bolts, screws) and *principal*. Here, the rationale is that not always the geometry of fasteners is fully specified but they may be simply indicated as annotations. Therefore distinguishing between principal shape components and fasteners allows to possibly discard the second ones during the comparison, thus permitting to focus only on the most specific parts of the assembly.

Additionally, each component is classified as *thin* or *normal* part, such that if the comparison among the shape of the single components is required in the query, it can be performed only on compatible ones discarding the others. The thin part class includes different types of objects, such as those similar to thin plates, or having an arbitrary shape with almost constant thickness distribution, or presenting a large emptiness in its bounding box. Different criteria are used to distinguish the typology of thin objects as described in [14]. For subassembly nodes, we consider the shape resulting from the Boolean union operation performed on the subassembly components, such that a single object is obtained on which the classification into *thin* or *normal* part and the various shape descriptors are computed. Such an overall assembly shape is useful to guarantee the possibility of evaluating similar assemblies from the structural and shape point of view, such that subassembly can be treated as it were a single unique part. Such decomposition into parts, subassemblies or a single component resulting from the merging of all the parts and subassemblies also correspond to the way designers may focus on a product. Actually, designers can consider the product either as a whole object with its characteristics (e.g. volume, gravity center), or focusing on subassemblies (e.g. for kinematics purposes) or parts (e.g. for manufacturing issues).

Figure 1 shows an example of the structural layer of an assembly model. The object is an engine formed by three sub-assemblies (S1, S2, S3): a piston, a crank shaft and a mass and two linking parts (P3, P10).

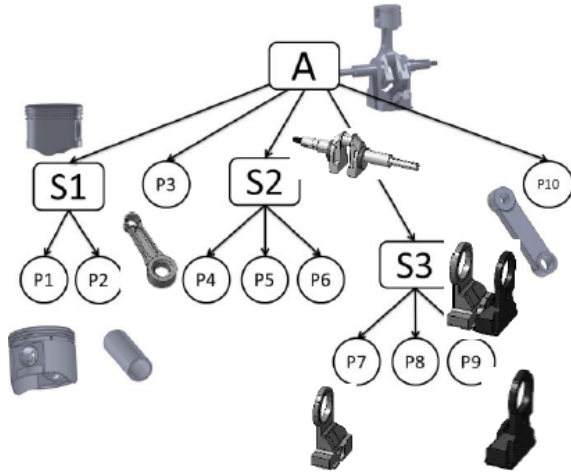

Figure 1 Example of structural layer of an assembly model

It is important to notice that the assembly decomposition depends on the context and, even if it represents a semantic organization, it is not unique. For example, the assembly can be organized in a way that the forthcoming assembly simulation steps are eased, or it can be organized with respect to visualization issues according to an octree-based decomposition, or it can be decomposed according to criteria based on the constitutive materials. Therefore, assembly similarity cannot strongly require same structures if not specifically requested by the user. However, we believe that there is a level of decomposition under which multiple decompositions of a same product will remain similar, and would in this case correspond to the smallest common denominators. Such an understanding can be performed at the level of the parts and subassemblies, but also at the level of the joints between the elements constituting the global assembly. This point is not further discussed in this paper.

Finally, all the elements in the tree are associated to data in the other information layer to fully characterize them.

4.2. Statistic layer

This layer collects several information that can be represented in form of numerical values for allowing a quick search and filtering. Statistics referring to the overall assembly or to sub-assembly nodes are:

- number of sub-assemblies,
- number of principal parts,
- number of fasteners,
- number of thin parts,
- number of linear patterns of repeated components,
- number of circular patterns of repeated components,
- number of reflective patterns of repeated components.

While statistics referring to the parts include:

- percentages of specific type surfaces (i.e. planar, cylindrical, spherical, free form, toroidal) with respect to the overall area,
- numbers of maximal faces (i.e. adjacent faces sharing the same underlying surface are considered as a single face) of a specific type surface (i.e. planar, cylindrical, spherical, free form, toroidal).

Statistics related to assembly interfaces are the number of elements in contact for each type (e.g. planar pair, planar-cylindrical pair).

The inclusion of information related to the presence of patterns can support the search of similar models having similar manufacturing or assembly processes.

Of course, based on this first list of statistics, additional descriptors can be used to enrich the characterization of the assembly model at different levels of the structural layer.

4.3. Shape layer

The shape layer includes the specification of the information related to the shape of the elements in the assembly. Useful for their comparison, this layer can also be interesting for the visualization. In particular, for each node of the structural layer (both parts and sub-assemblies), two mesh representations are associated together with several shape descriptors. The first is a rather precise model, the second corresponds to its rough representation (e.g. convex hull or more simply its bounding box). These double representations allow both a fast browsing of the objects and of the search results as well as the specification of both precise and rough queries with unprecise shapes. This is quite useful during product design when the shape is under development and it is quite reasonable to search for possibly re-usable products that share the main behavioral (e.g. degree of freedom) and overall shape characteristics. For each intermediate node (i.e. nodes associated to a sub-assembly), meshes and shape descriptors are provided and computed as previously described.

The choice of considering different shape descriptors associated to a single shape is due to the fact that it has been demonstrated that there is no best shape descriptor for the comparison of each shape type [9]. On the contrary, depending on the type of object a specific shape descriptor performs better. In our model, we intend to consider descriptors related to both the overall component and to its shape variation. Among the descriptors of the first type, we consider the volume and the surface area, which are size dependent. The other shape descriptors considered for the nodes in the structural graph are the spherical harmonics and shape distribution, which perform well with prismatic parts and shapes of revolution of which are mostly composed the mechanical products we are considering [9]. Therefore, depending on the values related to the percentages of surface type of the component (at the statistic layer), the comparison is activated to the concerned descriptor or to a weighted combination.

4.4. Interface assembly layer

This layer encodes the relationships between the different parts in an assembly model regardless the assembly organization. Therefore, it consists of arcs linking leaf nodes. Links between sub-assemblies and the rest of the assembly components can be obtained by simply considering the arcs that do not join the sub-assembly components. The possible relationships between two parts can be grouped into *contact*, *interference* and *clearance* [15] as shown in figure 2.

Two parts are in contact, if they touch along low-level geometric entities such as faces, edges or points without any shared volume. Two parts define an interference if a common volume exists between them. This relation cannot exist between two real objects, however during the modeling phase it may happen for instance after local shape simplification for simulation.

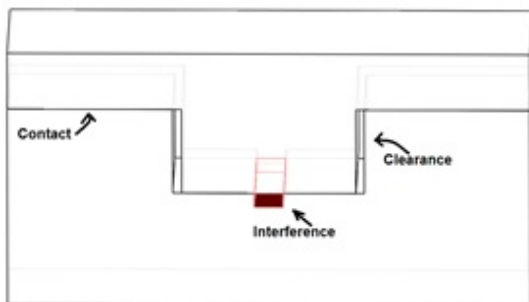

Figure 2 Possible relationships between parts

Another possibility is due to some tolerances in the modelling, i.e. still at the intermediate design stage

where dimensions are not fully tuned or there are tolerance issues. Since interference should not exist in a correct assembly model, they are not included in the EAM and, if present, are treated as contact.

Clearance occurs when the distance between two surfaces of two parts is meaningful for the considered assembly, i.e. it is a small non-null distance between two parts in the assembly. This case is rather ambiguous since the design intent can correspond to both non-contact and contact configurations (i.e. due to tolerance problems).

The interface layer is itself a multilayered one. Clearance and contacts are further detailed in terms of the types of kinematic pairs between parts, i.e. number and types of geometric elements, which are (almost) mating. At the lowest level, the couples of geometric elements (points, edges or faces) in contact of the two parts are specified, while at the highest level these are classified according to the resulting assembly feature [19] obtained combining the effect of kinematic pairs. In particular, we classify the contacts and clearance as *positioning* and *interlocking* types [2] depending on the final degree of freedom (DOF) they allow. In particular, interlocking configurations are those that prevent any direction movement, i.e. with zero DOF (see Figure 3). Finally, arcs have associated the attributes specifying the DOF between the linked parts in the assembly.

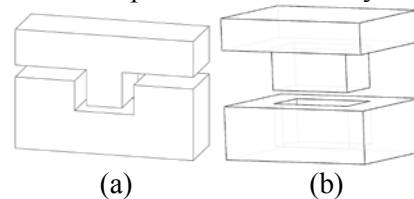

Figure 3 Examples of positioning (a) and interlocking configurations (b)

5. THE RETRIEVAL FRAMEWORK

CAD systems use different and proprietary file formats, able to store all the information directly inserted by the user during the design of the specific parts. The content may vary according to the type of functionalities provided by the specific CAD system, therefore building a generic retrieval system cannot trust on the presence of specific data. Furthermore, especially when different companies are working together for the specification of complex products, standard formats for the CAD data exchange are generally used.

Thus, in our framework we adopted the STEP standard format to read the assembly models. In this format many information, such as the relationships between the components, are not stored, while some

annotations may be included as functional information in the file. Anyway, we consider only the geometric data since the user provided annotations might be by their nature not accurate.

The framework considers both an off-line process and real-time processes. Off-line process is adopted for the evaluation of the EAM for all the models in the databases on which the search has to be performed. Real-time processes evaluate the descriptors on the query and accomplish the comparison with the stored models. It must be noted that the EAM is a very rich model, including many information on the represented assembly. Some information is apparently redundant, but it has the advantage to allow scalable queries. Therefore, a complete EAM version is computed only for the stored models, whereas for the query only those layer information assessable on the required detail are computed and exploited for the matching, thus reducing the complexity of the system.

5.1. Architecture

The architecture of the framework is illustrated in Figure 4 and it shows the different modules and how they communicate at the different levels. There are three main layers: the user interface layer, the functional layer and the data layer.

The user interface layer is responsible of the visualization tasks and user interaction activities. It provides support for i) the visualization of the EAM; ii) the search query specification; iii) the browsing of the search results. With the graphic user interface the designer may easily specify queries, search criteria, filters for the visualization of the EAM and the dataset to be used for the retrieval process. The EAM visualization module allows picturing an assembly model by means of a graph structure, whose nodes can be selected to enquire the content at the different levels of details. The geometry of the overall assembly, as well as the one of the intermediate nodes and leaves, can be previewed, thanks to stored mesh

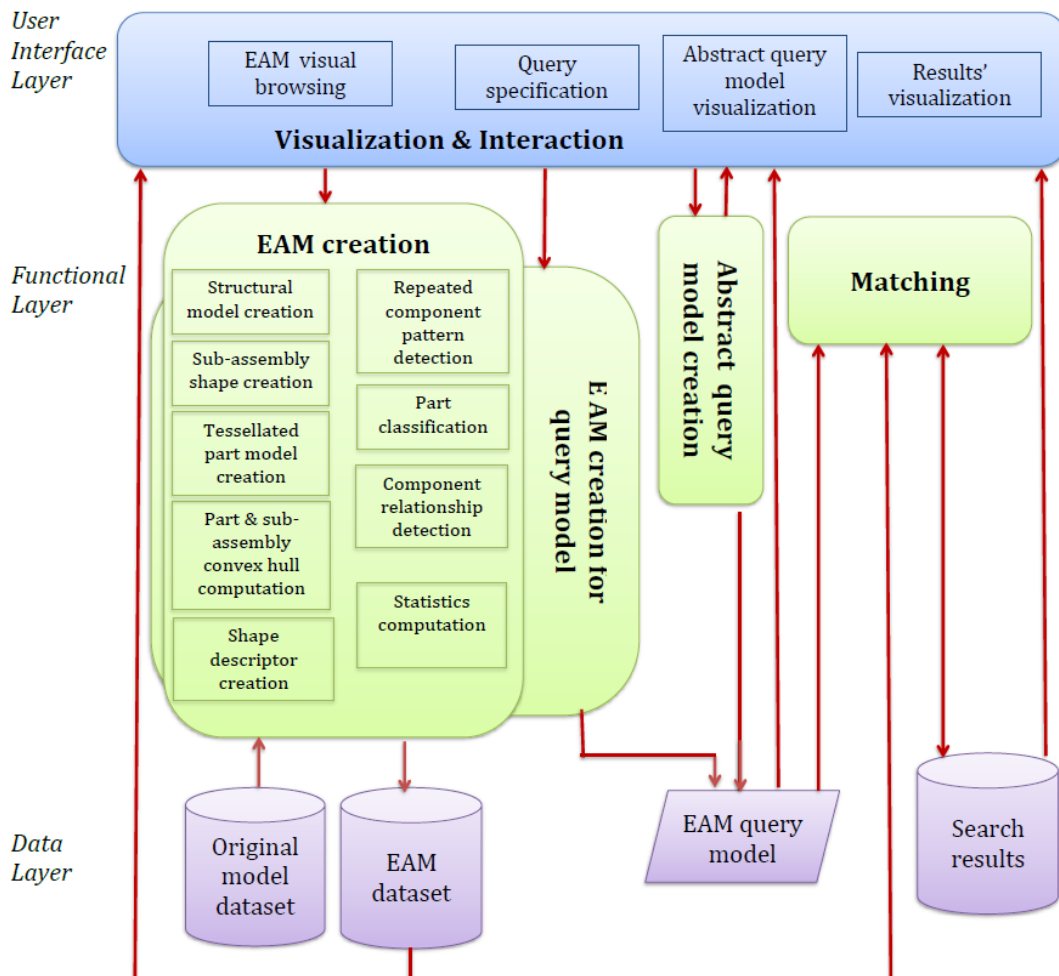

Figure 4 The framework architecture

models.

The functional layer contains the main modules of the framework. It manages the creation of an EAM from CAD assemblies in which explicit and implicit information present in the CAD model are made available. Moreover, it deals with the creation of the EAM of the query using either an existing model (i.e. a STEP file) or an abstract model specified by the user through the user interface layer.

The last layer is the data layer, which provides the input for the functional layer and contains the elaborated data.

At the operative level, as first step, it is necessary processing the databases used for the retrieval. Each file of the dataset is processed by the module "EAM creation". In this phase, a file is created where all the extracted information are archived.

Different possibilities are foreseen for the assembly search. If the user wishes to retrieve all the models similar to an existing CAD model, the module "EAM creation for query model" generates its assembly descriptor using the "EAM creation" as for the models in the database. Conversely, if the user is interested in finding models with some specific structural characteristics, the "abstract query model creation" module creates the corresponding parts of the assembly descriptor. This means that the user, through the interface, can build a graph specifying several attributes, such as a rough component shape. The user indicates if a node is a part or a subassembly and assigns its attributes. The same happens for the arcs, which can express parental or contact relationships. This operation is possible thanks to the interaction with user the graphic interface module, which allows the user to specify the abstract query in graph format.

When the dataset is entirely processed and the user specified his/her own search criteria, the search process is managed by the "matching" module. This module communicates with the user interface layer for displaying the obtained results with their associated measures.

5.2. Module descriptions

EAM creation

Since STEP file contains only part of the information required for creating the enriched assembly model, several geometric reasoning processes on the assembly model need to be performed to extract the missing information and generate the multilevel assembly descriptors. When reading the STEP file the compo-

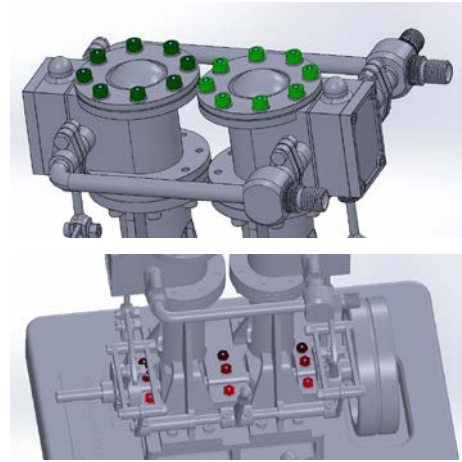

Figure 5 Examples of circular and linear patterns of repeated components

nents and links of the structure layer of the EAM are created from the hierarchy of the assembly model. For each leaf, statistics are computed. Then, for the whole assembly and the related sub-assemblies, patterns of repeated components are detected using the module described in [4], which identifies linear, circular and reflective arrangements of parts. Generally, repeated components are explicitly indicated in the STEP file. In case no indication is present, components are considered repeated when presenting the same values for the associated statistics (i.e. number of faces of a specific type and related area percentage) and for the volumes and surface areas. Of course, such criteria do not fully characterize repeated components but represent necessary and easy to check conditions to identify them.

Then, for all the sub-assemblies, the resulting shapes are evaluated (see section 3.1). For each of them and for each leaf in the assembly, the corresponding tessellation (if not already present in the dataset) is computed together with the corresponding shape descriptors. Tessellation is also used to detect the typology of the type of the corresponding part (i.e. thin or normal) according to the methodology described in [14], which uses D2 shape distribution and ratios among the bounding box characteristics (e.g. diagonal, width) to distinguish parts, see figure 6.

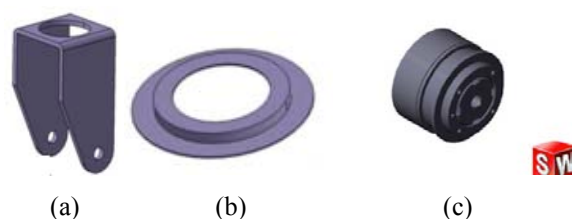

Figure 6 Examples of thin (a, b) and normal parts (c)

The interface assembly layer is then created by analyzing the reciprocal relationships between components. This kind of information is not stored in the STEP file, therefore we have to detect the possible part interactions only by exploiting the geometry data available in the STEP file. We use the functionalities provided by the API of the commercial system SolidWorks for the detection of the contact and the clearance. This functionality allows accessing to the faces (or edges or vertices) formed by the non-regularized intersection formed by two parts.

The module for detecting and evaluate the relationships between parts includes the following tasks:

- i) **Detection of clearances.** According to the description provided in the interface layer, we retain the clearances with distance lower than a given threshold.
- ii) **Identification of parts in contact.** For each clearance, we identify the involved parts.
- iii) **Identification of contacts between parts.** We compute the non-regularized intersection between the parts having null clearance.
- iv) **Identification of kinematic pairs.** The analysis of the typology of the elements involved in the non-regularized intersections allows the identification of kinematic pairs. For example, if a planar/cylindrical face is involved in the non-regularized intersection, it indicates that the two parts are in contact through two planar/cylindrical faces. In case of points and curves in the non-regularized intersection, additional geometric verifications are needed to identify the type of the faces. This additional checking is not presented in this paper.
- v) **Identification of the type of contact.** Connected parts of the non-regularized intersection give rise to specific degree of freedom. They are further analyzed by combining the kinematic pairs' degree of freedom [3] to detect weather they correspond to just a positioning relation or if the components are interlocked.

Finally, to detect if components correspond to fastener elements or principal ones, whenever they are not explicitly annotated, a software module is foreseen. It is worth to repeat that the aim of this classification is to guarantee that very similar products can be retrieved independently on the fact that specific standard fasteners are explicitly modelled or not. Therefore, this classification can be quite rough, just indicating negligible parts for the comparison.

Thus, only components having a volume within a certain range will be analyzed and compared to reference shapes of the most suitable fastener category. The choice of the fastener category will be based on the number of components in contacts. Components not satisfying the similarity threshold will be classified as principal.

Query EAM creation

As mentioned before, the graphical user interface provides various functionalities to specify the query, which include the creation of an abstract EAM model, in which the various layers can be fully or partially detailed. To specify the query, the user can select all the characteristics stored in the EAM. In this process, the interesting values can be specified by the user or automatically computed from the provided example, which can range from a precise CAD assembly model to an abstract assembly graph (Figure 7).

When the query corresponds to an existing CAD model, the EAM is created using the same "EAM creation" module previously described. If during the query specification, the user relaxes some characteristics, which he/she considers irrelevant, the corresponding evaluation procedures are ignored.

In case of an abstract query, the user provides its ideas without building an assembly model in a CAD system. For abstract queries, the mandatory information is the number of constituting principal components and related interface links. The abstract query creation is allowed thanks to the user interface in which the user can add some nodes specifying different attributes linking the nodes through arcs and specifying the type of the arc, i.e. a structural arc or an interface arc and in the last case with the label regarding the constraint. The attributes that the user can specify are those described in the different layers of the enriched assembly model descriptor. In this case the attributes specified by the user are used as search criteria during the matching process.

Optionally a percentage of allowed variation on the various elements can also be inserted to speed up the retrieval process. It allows a pre-filtering of the candidate most similar models through the verification of the concerned statistics values.

Matching

The matching problem is faced at the different levels of the EAM in a top down manner. If the user expresses ranges in which two assemblies are considered similar, e.g. allowed percentage of different

components or relations, a filtering can be applied based on the concerned statistics to reduce the number of models to be compared.

The problem of finding the matching between two assembly models is translated into the problem of finding an isomorphism between two EAMs based on the specified criteria.

The EAM can be seen as an attributed graph structure. Thus, a partial shape correspondence between two graphs corresponds to the problem of finding their maximum common sub graph (MCS). Among the various techniques proposed for the identification of the MCS [1], the chosen strategy is to solve the problem of the identification of the maximum clique (MC) [13]. To compute it, an association graph is constructed in which nodes equivalent in the two attributed graphs to be compared are mapped into a single node. Similarly, arcs in the associated graph are present when the corresponding nodes in the attributed graphs are connected in the same way. The maximum clique thus corresponds to the maximum

set of nodes all connected together of this newly defined association graph. In our system, the maximum clique finding problem is solved using an existing method exploiting the simulated annealing technique and described in [7][17]. Two nodes are considered equivalent if they have the same attributes specified by the user through the search criteria accessible from the interface. To limit unnecessary comparisons, if the search is looking for assemblies similar in all the aspects, at first the comparison is performed on the structural nodes and assembly interface layers, then the geometric matching on the part geometry is performed only on the returned corresponding candidates. In this case, nodes are then considered equivalent if they are associated to the same type (principal or fastener) of components presenting the same type of shape (thin or normal). Similarly, arcs are considered equivalent when at the interface layer, corresponding arcs have the same classification and DOF. Statistics information at the node and interface layer are then used to adjust the similarity ranking. Being the assembly comparison important at the various





Query model	
	Retrieved
Interface layer Same #rotation and #translation	
Structure layer 1 reflective pattern and 2 circular pattern	
Shape layer Similar volume at 30%	
	Not -retrieved
	

Figure 7 Example of assembly retrieval

information layers, the matching process provides as result a vector of measures: the first measure refers to the identified cliques, the second to the interface statistics, the third is related to the component shape similarity.

Figure 7 illustrates an example of assembly retrieval results obtained applying various criteria at different stages, thus allowing a refined browsing of the data set. The model used as query has two main parts (one is the reflection of the other) and a set of screws and a bolts (both arranged in a circular pattern).

At the first stage, the search is looking for models in which there are two parts in contact with the same number of possible rotations and translations as in the query model. The assemblies that satisfy these requirements locally are shown in the second row in Figure 7.

In the second stage the retrieved set of assemblies is filtered according to the pattern type of the query model. Thus, the system retrieves the models with a reflective pattern and two circular patterns. This step allows reducing the number of false positive retrieved before.

In the last stage, dimension information are used to filters the achieved results such that the returned assemblies (fourth row in Figure 7) present the same volume with 30% of tolerance.

Last row in the figure presents some of the models not retrieved at the first stage.

This example shows that for searching assemblies a single key is not sufficient to have adequate results, while combining several queries the results improve. In this sense, the proposed approach helps finding similar assembly while being closer to the user intent. If the user really wants an assembly made of 4 screws, only such assemblies will be retrieved. However, if the user is interested in screwed assemblies, they will all be retrieved whatever the number of screws.

6. CONCLUSIONS AND FUTURE WORKS

In this paper, a framework for the retrieval of similar CAD assemblies has been proposed. It is based on a three layers architecture. CAD models available in the database are pre-processed off-line and enriched with data extracted from them. Once enriched, the so-called Enriched Assembly Models are available and ready for the matching step. Then, a query model is created by the user and compared to each EAM of the database using specific criteria. Both the creation

of the query model and the criteria used for the comparison can follow different scenarios.

The proposed Enriched Assembly Model is a first step toward the definition of a unified multi-level structure for CAD assembly description. Together with the definition of an advanced hierarchical matching process, it helps retrieving CAD assemblies in huge databases.

Our approach has the following advantages. It allows the automatic computation of the joints between the components, as well as a pre-classification of the parts so as to speed up the matching step. Moreover, query models should not be fully specified thus enabling fuzzy queries very useful in the early design phases where the product specifications are not fully known.

The proposed EAM is open so as to incorporate more advanced shape descriptors enabling more accurate retrieval of CAD assemblies defined by such complex features. The framework is under development and we are currently completing the module for the automatic identification and interpretation of the assembly component interface.

REFERENCES

- [1] Bunke, H., Foggia, P., Guidobaldi, C., Sansone, C., Vento, M., (2002), "A comparison of algorithms for maximum common subgraph on randomly connected graphs", in *Structural, Syntactic, and Statistical Pattern Recognition*. Springer, p. 123–132.
- [2] Chan, C. K., Tan, S. T., (2003), "Generating Assembly Features Onto Split Solid Models, *Computer-Aided Design*, vol. 35(14), pp. 1315–1336.
- [3] Chen, X., Gao, S., Guo, S., Bai, J., (2012), "A flexible assembly retrieval approach for model reuse", *Computer-Aided Design*, vol. 44(6), pp. 554-574.
- [4] Chiang, L., Giannini, F., Monti, M., (2015) "Identification of regularities in CAD part and assembly models", in *Proceedings of PLM'15 IFIP WG 5.1 12th Int. Conf. on Product Lifecycle Management*, Doha.
- [5] Deshmukh, A. S., Banerjee, A.G., Gupta, S. K., Sriram, R. D., (2008), "Content-based assembly search: A step towards assembly reuse", *Computer-Aided Design*, vol. 40(2), pp. 244-261
- [6] Falcidieno B., Giannini F., Léon J-C., Pernot J-P., (2014), "Processing free form objects within a Product Development Process framework", in *ASME-Press "Advances in Computers and Information in Engineering Research"*, J. G. Michopoulos, C. J.J. Paredis, D. W. Rosen, and J. M. Vance (Eds.), vol. 1, pp. 317-344.

- [7] Giannini, F., Lupinetti, K., Monti, M., (2013), "Search of subparts in CAD models", technical report CNR IMATI-GE n° 21/2013.
- [8] Gupta, S. K., Cardone, A., Deshmukh, A. S., (2006), "Content-based search techniques for searching CAD databases", *Computer-Aided Design and Applications* vol 3(6), 811-819.
- [9] Iyer, N., Jayanti, S., Lou, K., Kalyanaraman, Y., Ramani, K., (2005), "Three-dimensional shape searching: state-of-the-art review and future trends" *Computer-Aided Design*, vol. 37(5), pp. 509-530.
- [10] Hu, K-M., Wang, B., Yong, J-H., Paul, J-C., (2013), "Relaxed lightweight assembly retrieval using vector space model", *Computer-Aided Design*, vol. 45(3), pp. 739-750.
- [11] Jayanti, S., Kalyanaraman, Y., Iyer, Y., Ramani, K., (2006), "Developing an engineering shape benchmark for CAD models", *Computer-Aided Design*, vol. 38(9), pp 939-953.
- [12] Miura, T., Kanai, S., (2009), "3D Shape Retrieval considering Assembly structure", in *Proceedings of Asian Symposium for Precision Engineering and Nanotechnology 2009 (ASPEN 2009)*.
- [13] Pelillo, M., (1999), "Replicator equations, maximal cliques, and graph isomorphism. *Neural Computation*", vol. 11(8), pp 1933-1955.
- [14] Pernot, J.P., Giannini, F., Petton, C., (2012), "Categorization of CAD models based on thin part identification", *Proceedings of TMCE 2012, Karlsruhe, Germany*, Ed. by I. Horváth, Z. Rusák, A. Albers and M. Behrendt, ISBN 978-90-5155-082-5, Karlsruhe.
- [15] Shahwan, A., Foucault, G., Léon, J-C., Fine, L., (2014), "Deriving Functional Properties of Components from the Analysis of Digital Mock-ups", *Engineering Computations, Emerald*, pp.16.
- [16] Tangelder, J. W., Veltkamp, R. C., (2008), "A survey of content based 3D shape retrieval methods" *Multimedia tools and applications*, vol. 39(3), pp. 441-471.
- [17] Tao, S., Huang, Z., Ma, L., Guo, S., Wang, S., Xie, Y., (2013), "Partial retrieval of cad models based on local surface region decomposition", *Computer-Aided Design*, vol. 45(11), pp.1239-1252.
- [18] Tao, S., Huang, Z., (2012), "Assembly model retrieval based on optimal matching", in *Software Engineering and Knowledge Engineering: Theory and Practice*, pp. 327-336, ed. Springer.
- [19] Ullah, H., Bohez, E. L. J., Irfan, M. A., (2009), "Assembly Features: definition, classification, and usefulness in sequence planning", *International Journal of Industrial and Systems Engineering*, vol. 4(2), pp. 111-132.
- [20] Zhang, J., Xu, Z., Li, Y., Jiang, S., Wei, N., (2013), "Generic face adjacency graph for automatic common design structure discovery in assembly models", *Computer-Aided Design*, vol. 45, (8-9), pp. 1138-1151.