



Science Arts & Métiers (SAM)

is an open access repository that collects the work of Arts et Métiers Institute of Technology researchers and makes it freely available over the web where possible.

This is an author-deposited version published in: <https://sam.ensam.eu>
Handle ID: [.http://hdl.handle.net/10985/15536](http://hdl.handle.net/10985/15536)

To cite this version :

Qiaorui SI, Qianglei CUI, Keyu ZHANG, Jianping YUAN, Gérard BOIS - Investigation on centrifugal pump performance degradation under air-water inlet two-phase flow conditions - La Houille Blanche - Revue internationale de l'eau n°3, p.41-48 - 2018

Any correspondence concerning this service should be sent to the repository

Administrator : scienceouverte@ensam.eu



INVESTIGATION ON CENTRIFUGAL PUMP PERFORMANCE DEGRADATION UNDER AIR-WATER INLET TWO-PHASE FLOW CONDITIONS

Qiaorui SI⁽¹⁾, Qianglei CUI⁽³⁾, Keyu ZHANG⁽²⁾, Jianping YUAN⁽⁴⁾, Gérard BOIS^{(5)*}

⁽¹⁾ National Research Center of Pumps, Jiangsu University, Zhenjiang, China, 212013, e-mail: siqiaorui@163.com

⁽²⁾ National Research Center of Pumps, Jiangsu University, Zhenjiang, China, 212013, e-mail: zhangky189@163.com

⁽³⁾ National Research Center of Pumps, Jiangsu University, Zhenjiang, China, 212013, e-mail: 786485282@qq.com

⁽⁴⁾ National Research Center of Pumps, Jiangsu University, Zhenjiang, China, 212013, e-mail: yh@ujs.edu.cn

⁽⁵⁾ LML, UMR CNRS 8107, Arts et Métiers ParisTech, Lille, France, 59000, e-mail: gerard.bois@ensam.eu

In order to study the flow characteristics of centrifugal pumps when transporting the gas-liquid mixture, water and air were chosen as the working medium. Both numerical simulation and experimental tests were conducted on a centrifugal pump under different conditions of inlet air volume fraction (IAVF). The calculation used URANS k-epsilon turbulence model combined with the Euler-Euler inhomogeneous two-phase model. The air distribution and velocity streamline inside the impeller were obtained to discuss the flow characteristics of the pump. The results shows that air concentration is high at the inlet pressure side of the blade, where the vortex will exist, indicating that the gas concentration have a great relationship with the vortex aggregation in the impeller passages. In the experimental works, pump performance were measured at different IAVF and compared with numerical results. Contributions to the centrifugal pump performance degradations were analyzed under different air-water inlet flow condition such as IAVF, bubble size, inlet pressure. Results show that pump performance degradation is more pronounced for low flow rates compared to high flow rates. Finally, pressure pulsation and vibration experiments of the pump model under different IAVF were also conducted. Inlet and outlet transient pressure signals under four IAVF were investigated and pressure pulsation frequency of the monitors is near the blade passing frequency at different IAVF, and when IAVF increased, the lower frequency signal are more and more obvious. Vibration signals at five measuring points were also obtained under different IAVF for various flow rates.

Key words:

Pump Performance, Two-Phase flow, Numerical-Experiment Comparisons, Vibration

Analyse de la dégradation des performances de pompes centrifuges en présence de mélange diphasique air-eau en entrée de roue

Un mélange diphasique air-eau alimente une pompe centrifuge pour en étudier les modifications de performance par rapport à de l'eau pure. Les analyses sont conduites à l'aide de simulations numériques et des expériences pour différentes valeurs de fraction volumique du mélange en entrée de la pompe. La simulation numérique utilise une approche instationnaire URANS avec le modèle de fermeture turbulente k-epsilon associé à une description Eulérienne pour chaque fluide, l'ensemble étant traité comme un milieu inhomogène. La distribution locale des caractéristiques du mélange ainsi que des lignes de courant à l'intérieur de la pompe et plus particulièrement de la roue sont utilisés pour permettre une analyse locale détaillée en particulier de l'évolution de la fraction volumique. La concentration d'air est importante à l'entrée de la roue et sur la face en pression des aubages dans les zones de forts gradients et les zones où se concentrent les zones tourbillonnaires à l'intérieur des passages inter-aubes. Les analyses portent prennent également en compte, outre différentes valeurs de la fraction volumique initiale, les variations du diamètre des bulles d'air et celles du débit global traversant la pompe. Les modifications des performances globales de la pompe, mesurées expérimentalement, sont plus importantes vers les bas débits. Elles sont confirmées, qualitativement et quantitativement par l'approche numérique retenue. Les mesures complémentaires de fluctuations de pressions en entrée et en sortie de pompe ainsi que des mesures de vibration sur le corps de pompe permettent une analyse en fréquence des signaux et leur mise en relation avec les résultats numériques sur les caractéristiques locales des écoulements

Mots-clefs :

Pompe, Ecoulement diphasique, Comparaisons calculs-expériences, vibrations.

I INTRODUCTION

Two-phase gas-liquid flows often happened in air conditioning systems, refrigerating, cryogenic, petroleum, nuclear power and also in sewage treatment. Centrifugal pumps play important roles in all these fields. It is well known that pump head will decrease under two-phase mixture conditions

54 compared to single-phase one. The degree of head degradation depends on geometrical, physical
55 and thermal conditions (Gülich [2014]). For a given pump geometry and increasing value of void
56 gas fraction, the head can be totally lost, the consequence of which can result in huge system
57 instabilities and pump degradations.

58 Several authors like Murakami et al. [1974a], Minemura et al. [1985] have proposed prediction
59 methods for the two-phase flow performances on axial and centrifugal type of pumps in order to
60 evaluate existing experimental measurement results with some visualization technique as well. A
61 non-exhaustive list of important published works is proposed in Si et al. paper [2017]. All these
62 models can be considered to be valid for low values of volumetric void fraction (max. 6%-7%) and
63 so, far from surge operating conditions that correspond to a rapid performance decrease of the
64 pump, the rate of which depend on the initial water flow rate. Just before such severe conditions,
65 several investigations have detected the presence of stationary bubbles at impeller entrance channels
66 for high gas fractions, being responsible for performance degradation of the pump (Murakami and
67 Minemura [1974 b]; Patel and Rundstadler[1978]; Sekoguchi [1984]. Estevam[2003] and Barrios
68 and Prado [2009]. Numerical simulations using URANS approach have been also performed in
69 order to determine local phenomena more precisely in such flow conditions. All numerical results
70 have in common that they show significant deviations between predicted and experimental overall
71 results for the head drop especially for gas fraction values higher than 6%. Recently, Müller at al.
72 [2015], have performed numerical calculation using a mono dispersed phase distribution model, the
73 results of which are compared with experimental results obtained from Kosyna[2001]. The
74 comparison on impeller blade static pressure distributions showed that some improvement should
75 be done for high flow rate in order to get better fit between numerical and experimental results.
76 However, most of the centrifugal pump impeller geometries that have been studied are designed
77 using two dimensional blade sections and constant passage width along the radius from leading to
78 trailing edge. There is still a need of experimental results combined with numerical ones to explain
79 the dynamic characteristics of centrifugal pump under air-water two-phase flow working condition.

80 In the present paper, experimental and numerical comparisons results are presented on two- phase
81 flow performance in a centrifugal pump designed with three dimensional shrouded impeller shape.
82 Numerical results have been performed using inhomogeneous model (instead of usually
83 homogeneous model), for which each fluid possesses its own flow field and the fluids interact via
84 interphase transfer terms and compared with overall experimental ones. In addition, inlet and outlet
85 transient pressure and vibration signals under four IAVF are analyzed with frequency to investigate
86 the dynamic characteristics.

87 **II PUMP GEOMETRY AND TEST RIG ARRANGEMENT**

88 A commercial single stage, single-suction, horizontal-orientated centrifugal pump with specific
89 speed ($\Omega_s= 65$) was used for the investigation, whose casing is typically combined with a spiral-
90 volute. The design parameters and global pump geometry, given by the manufacturer, can be found
91 in Si et al. [2017]. The test rig is schematically shown on Figure 1. In this open loop, air injection
92 system is driven by a compressor. Air flowrate is measured by micro-electro mechanical systems
93 flow sensors, which could supply volume air flowrate value on standard conditions (25°,
94 101325Pa). Air-water flow is sucked by the pump, goes through the regulating valve and finally
95 arrives into the downstream tank. Air bubbles exhaust to external space in open tank and the left
96 pure water run to the upstream tank. Volume flowrate of pure water was measured by an
97 electromagnetic flowmeter set between upstream tank and the air supply device. Pump head and
98 global efficiency is also obtained following ISO 9906: 2012.

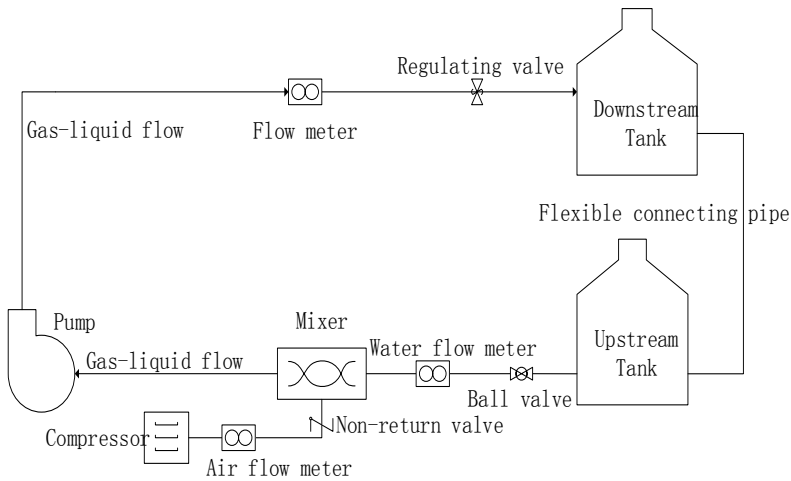

Figure 1: Test rig

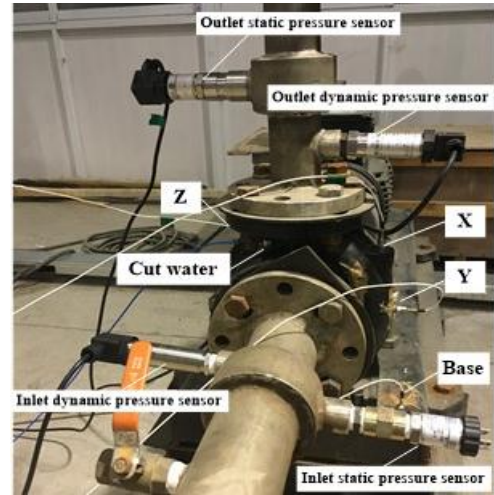

Figure 2: Sensor locations

It has to be noticed that the inlet pipe loop is in horizontal and part of the inlet tubing is transparent in order to observe the inlet bubble distribution. This allows see a rough global view of bubbles size. At this step, only air volume flow rate is measured, bubble diameter distribution including bubble number per volume at pump inlet is not available. Measurements are performed using the followed procedures: a constant void fraction is set by changing the throttle vane position and consequently obtained the corresponding water flow rate. **Inlet air volume flow rate was transferred after knowing the pump inlet pressure value from the inlet static pressure sensor in order to calculate the inlet air void fraction.** Measurement uncertainties calculated by instrument precision are 0.33m error on pump head and 2.4% on pump global efficiency. Figure 2 shows a general view of sensor locations close to the pump environment.

III EXPERIMENTAL PUMP PERFORMANCE CHARACTERISTICS

The test loop condition were that 2m water high level inside the tank, air injection is performed with the same inlet compressor pressure mainly 60kPa. Four injecting tubes around the inlet pipe section inject air bubbles with the same direction of the water flow. The above loop setting could ensure that no cavitation happened during the experiment process. The water flow rate is kept constant, changing the air injecting flow rate and get inlet air void fraction values at 1%, 3%, 5%, 8%, 9% and 10%.

Figure 3a shows pump performance curves at different given void fraction values. It can be seen, as already pointed out by several previous researchers, that pump performance starts to be significantly lower when void fraction reaches 3% and more. The value of the head performance degradation also depends on the water flow rate. A decrease of 20% of head compared with single phase shut-off conditions is achieved for all water flow rates below nominal conditions for void fraction going up to 7%. Lowest void fraction up to 10% can be achieved without pump surge for water flow rates around 32~40 m³/h. These values correspond to 0.7 up to 0.8 Q_d , compared to a manufacturer given operating pump flow rate of 50.6m³/h. Other two phase flow experimental results are also plotted in Figure 3b, using the theoretical head coefficient. All points are on a quite unique curve whatever the void fraction value is. This result validates all semi-empirical and one dimensional model assumptions that have been used for most existing approaches in the literature for such a pump geometry. As a consequence, efficiency values (from Si et al [2017]) are always lower than efficiency for zero void fraction, which is obviously normal due to increasing impeller passage losses when two-phase flow conditions are existing. One can also observed that maximum efficiency locations are displaced towards lower water flow rates when void fraction is increasing. This can be attributed to blockage effects at impeller inlet section which may modify the incidence angle values.

134

IV NUMERICAL SIMULATION ANALYSIS

135

136

137

138

With the validated CFD model, values of blade forces, pressure heads, and inlet air void fraction (IAVF) distributions inside the pump can be analysed. These values are very difficult and expensive to be measured using experimental instrumentation. All of this could help us well understand inner flow characteristics of centrifugal pump working under air-water two-phase flow condition.

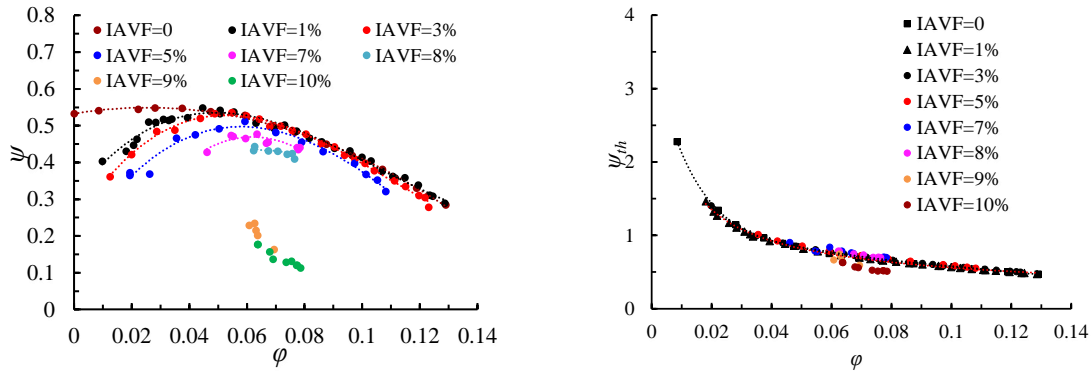

(a) Head coefficient

(b) Theoretical head coefficient

Figure 3: Pump performance modification for different values of IAVF

139

140

141

142

143

IV.1 PUMP MODEL AND MESHES

144

145

146

147

148

149

150

151

152

153

154

155

The pump was divided into five component parts such as the inlet, impeller ring, chamber, impeller and volute to build a model mesh for a complete pump. This process would allow each mesh to be individually generated and tailored to the flow requirements in that particular component. The influence of boundary conditions was investigated to discard any effect on the numerical results, particularly on the inlet and outlet part. These last two parts are extended to assure that the flow closed to inlet and outlet parts corresponds to a fully developed condition. The grids for the computational domains were generated using ANSYS ICEM-CFD14.5 with blocking method. The independence of the solutions from the number of grid elements was proven by simulating the flow field with different numbers of grid elements, as shown in Figure 4a. The resulting pump model consisted of 2775915 elements was chosen for rotating and stationary domains in total. Structured hexahedral cells were used to define the calculation domains, whose detail are shown in Figure 4b.

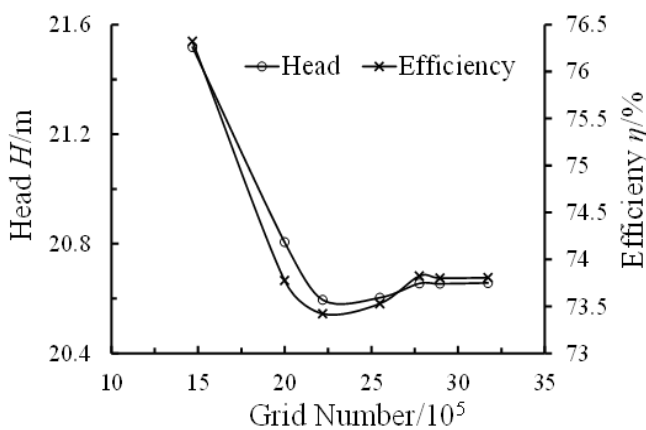

(a) Grid number dependence

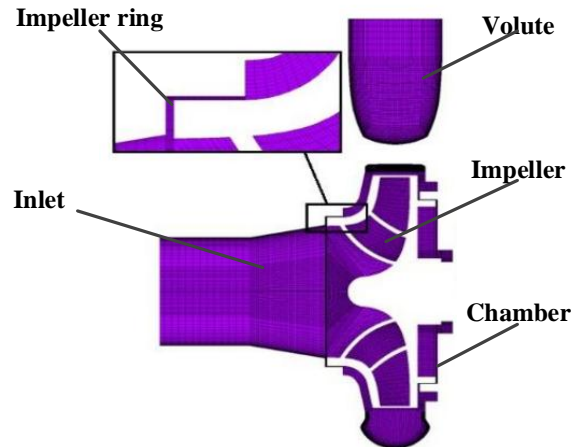

(b) Structure Mesh

Figure 4: Three dimensional numerical domain with local meshing

156

157

158

159

160

IV.2 BOUNDARY CONDITION AND NUMERICAL MODELS

161

162

163

The professional CFD software ANSYS CFX14.5 was used for the simulation. Three dimensional URANS equations were solved using the $k-e$ turbulence model, with boundary conditions of total pressure at the inlet and mixture mass flow rate at the outlet. Smooth wall

164 condition was used for the near-wall function. Inhomogeneous model also named the inter-fluid
 165 transfer model was chosen to adapt the Eulerian-Eulerian multiphase flow. In this model each fluid
 166 possesses its own flow field and the fluids interact via interphase transfer terms. Thus, this model
 167 provides one solution field for each of the separate phases. Transported quantities interact via
 168 interphase transfer terms. Furthermore, particle model is applied for the interphase transfer terms,
 169 which is suitable for modeling dispersed multiphase flow problems such as the dispersion of air
 170 bubbles in a liquid. Initial bubble diameter set as 0.1mm and 0.2mm.

171 The interface between the impeller and the casing is set to “transient rotor-stator” to capture the
 172 transient rotor-stator interaction in the flow, because the relative position between the impeller and
 173 the casing was changed for each time step with this kind of interface. The chosen time step (Δt) for
 174 the transient simulation is 1.718×10^{-4} s for nominal rotating speed, which corresponds to a changed
 175 angle of 3° . Within each time step, 20 iterations were chosen and the iteration stops when the
 176 maximum residual is less than 10^{-4} . Ten impeller revolutions were conducted for each operational
 177 condition in order to reach stable periodicity results for convergence criteria, and the last four
 178 revolutions results were kept for analysis.

179 It is quite well known that unsteady calculation is mandatory for rotating machinery analysis when
 180 looking at rotor-stator interaction problems instead of steady conditions. This is more evident when
 181 two-phase flows are investigated. As an example, figure 5 illustrates the big differences on air void
 182 fraction distribution inside the impeller corresponding for both two approaches.

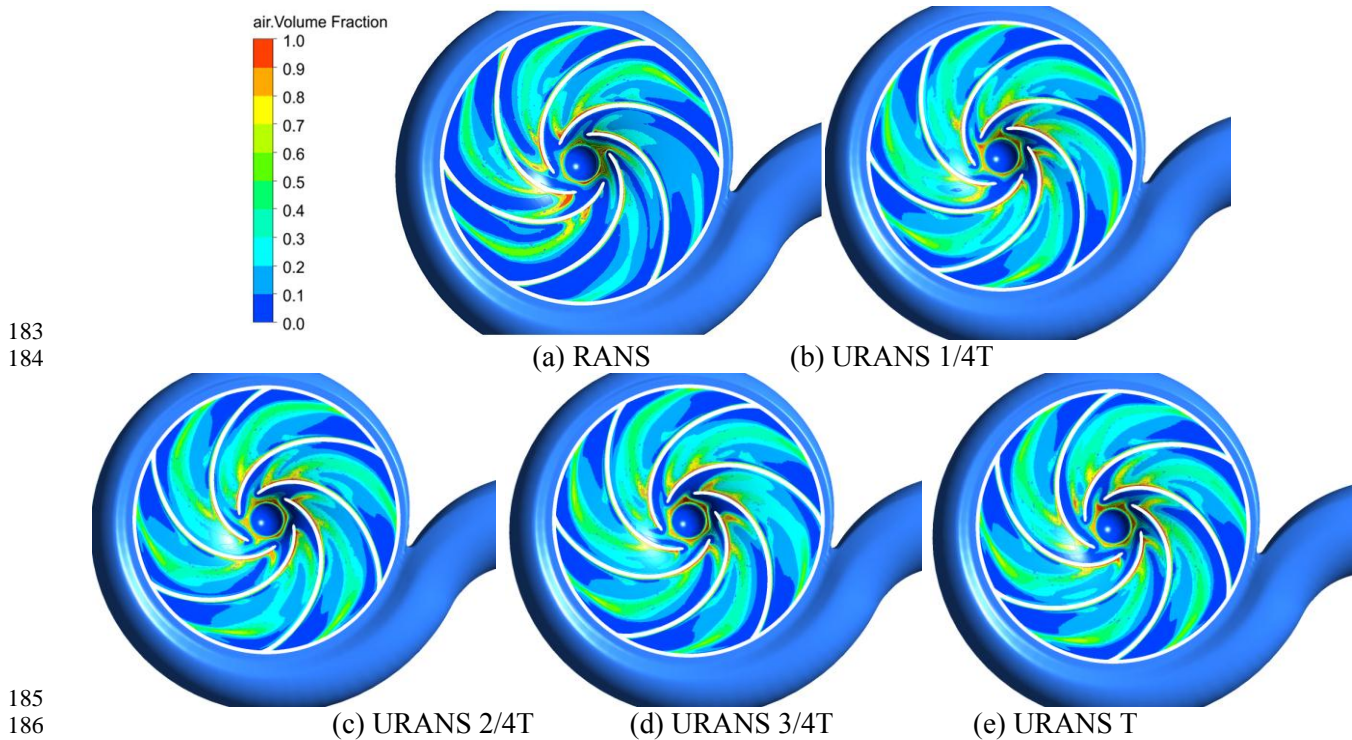

Figure 5: Example of void fraction distribution inside the impeller passage

188 IV.3 Numerical results

189 IV.3.1 Pump performance comparison between the simulation and experiment

190 Comparisons between simulation and experiment when pump works at pure water condition are
 191 quite good as already shown in a previous publication done by the same research team (SI et al.
 192 [2017]). This means that the calculated domain, meshes, boundary condition and numerical
 193 turbulence models are suitable for further analysis. Performance curves of numerical simulation and
 194 experiment with different IAVF are shown in Figure 6. Numerical results show that the calculation
 195 is quite sensitive to initial bubble diameter value for small flow rates. Numerical results are quite
 196 comparable up IAVF= 7% for the adapted bubble diameter. From experimental investigation, it
 197 seems that pump performance is less sensitive to inlet bubble diameter values than numerical results.

198 This result also needs more investigation in order to explain it. The simulation results are believable
 199 if the adequate initial bubble diameter is chosen.

200
 201

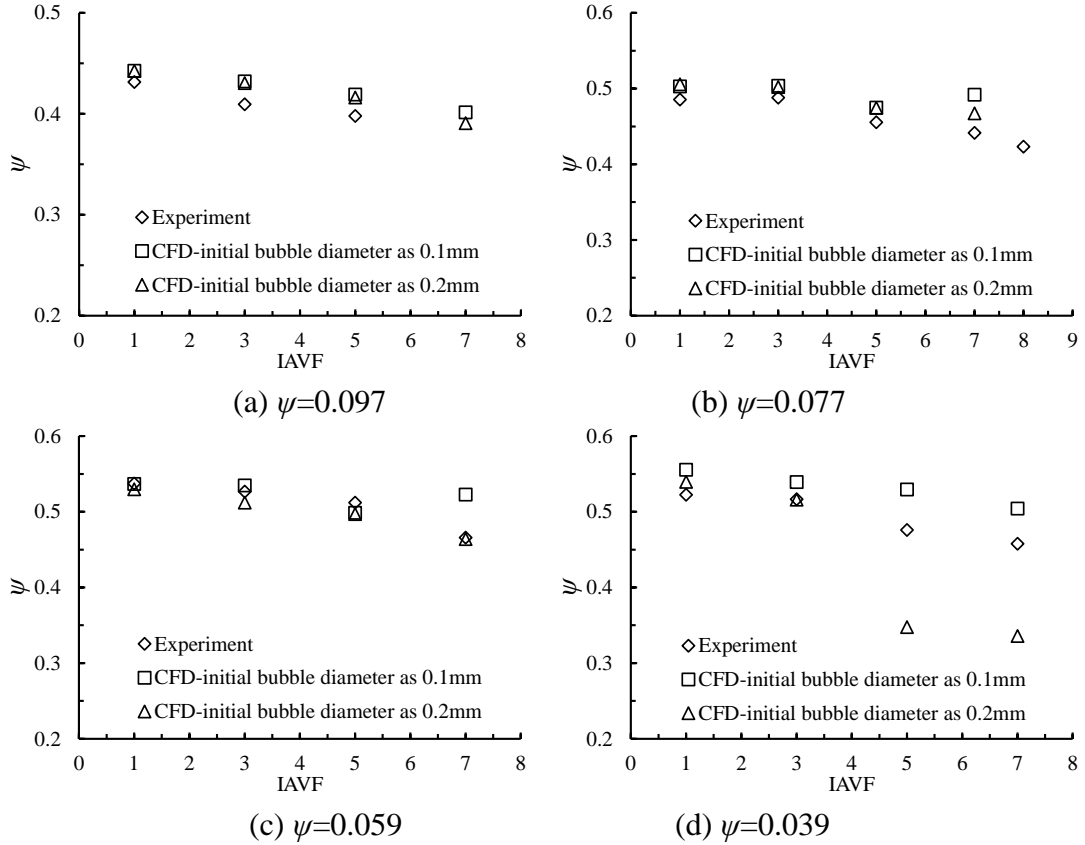

202
 203
 204
 205

Figure 6: Comparisons of head pump coefficient for different IAVF values

Table 1: Air distribution in middle section of the pump under different IAVF

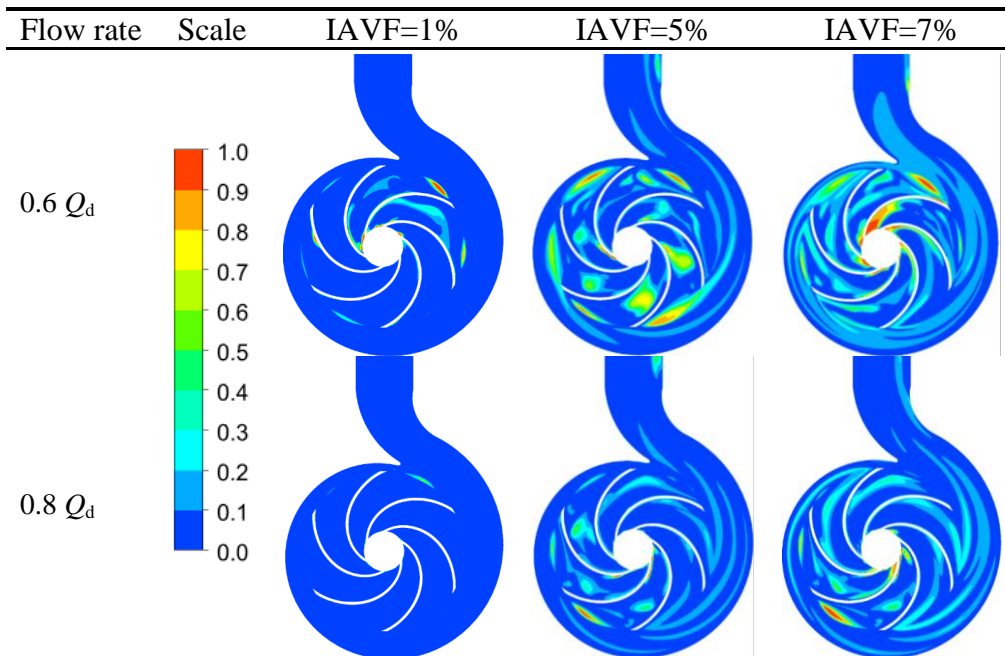

206 Q_d

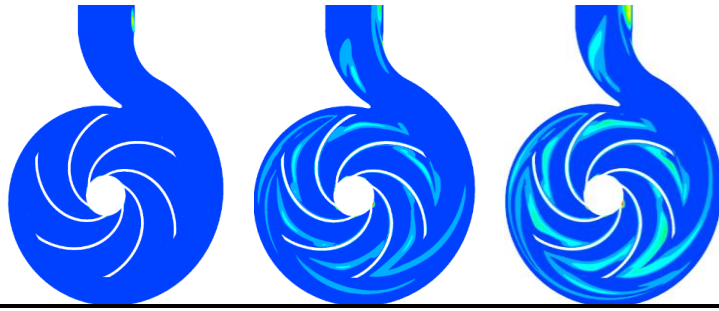

207 *IV.3.2 Flow analysis inside the impeller and volute*

208 The transport air-water ability of the pump mainly depends on air and water distributions inside
 209 the flow channel. Table 1 shows the local air void fraction distribution inside the impeller and
 210 volute channel for three flow rate and for three IAVF values. It can be seen that air void fraction is
 211 bigger inside the impeller than volute channel for all three flow rates and all three IAVF. Air
 212 bubbles distribute on pressure side of the blade and are detained more and more inside the impeller
 213 channel near “wake” area when IAVF increase. Bubbles take over 60% part of the channel when
 214 IAVF increase to 7% in all three flowrates, which is probably the reason why pump performance
 215 breaks down. The biggest value of air void fraction decrease as pump flowrate increase, which
 216 means centrifugal pump are more sensitive to the air at small flow rates. Air bubbles are also
 217 detected on blade pressure side from leading edge to the middle channel parts. Further
 218 investigations from numerical results are needed in order to evaluate high loss locations due two
 219 phase conditions and on impeller blade static pressure distribution as pointed out in the conclusions
 of Müller’s paper [2015].

220 *IV.3.3 Unsteady pressure evolution*

221 Numerical unsteady pressure evolution results, corresponding to position p1-p6, are given on
 222 **figure 7a**. Temporal pressure coefficient evolution results are obtained for a flow rate equivalent to
 223 $Q/Q_d=0.8$, as is shown in figure7b. The corresponding FFT chart is given on figure 7c. Comparative
 224 FFT chart under $0.6Q_d$ is given on figure 7d. One can detect that pressure fluctuations are stronger
 225 when inlet void fraction increases with a maximum power value for 5% at blade passing frequency
 226 value. Amplitude of the pressure coefficient always present bigger values if the monitoring points
 227 near the volute tongue. FFT results of the pressure coefficient at the two flowrates show the same
 228 variation law when IAVF increase. Smaller flowrate give more low frequency characteristic.

229 When looking at vibration results (which are presented in the next section), same kind of results
 230 can be found. It is interesting to notice, as already pointed out in section IV.3.2 that this corresponds
 231 to the fact that regions with high void fraction levels are not any more close to the impeller walls
 232 but are pushed in the main flow when flow rate is decreasing and IAVF is close to 5% (see results
 233 also from Table 1) .

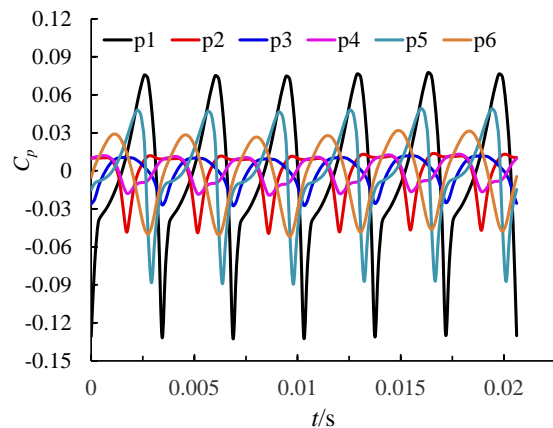
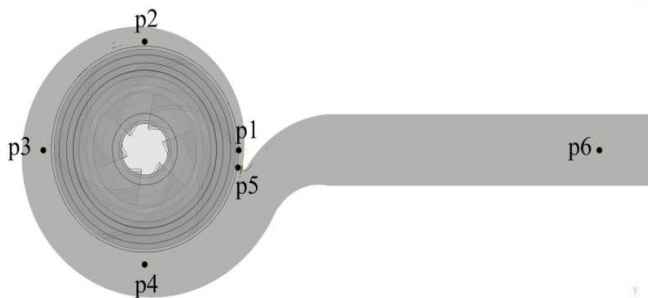

234 (a) Location of monitoring points (b) Temporal pressure coefficient evolution when IAVF=3%

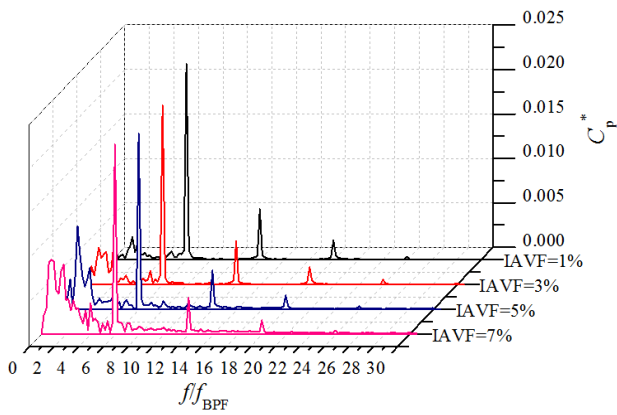

(c) FFT results at p6 when $0.8Q_d$

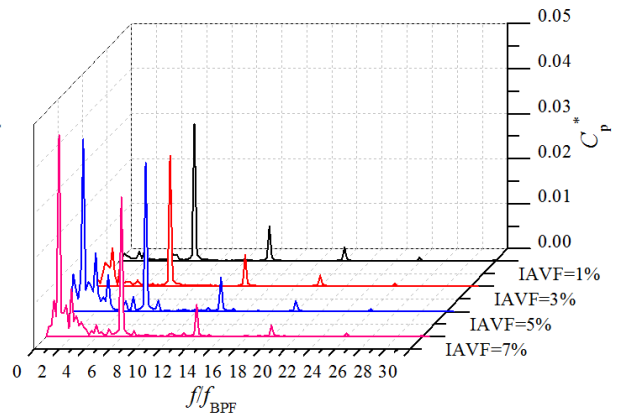

(d) FFT results at p6 when $0.6Q_d$

Figure 7: Unsteady pressure evolution of the monitoring points

IV.3.4 Casing vibration experimental results

Part of vibration results, obtained by accelerometer X (radial position- see figure 2), are given using FFT analysis for the same flow rate $Q/Q_d=0.8$ and for several IAVF conditions. It can be seen, from figures 8a to 8e, that maximum acceleration amplitude always occur at blade passing frequency (6 impeller blades). When IAVF increases, lower frequencies appear with growing amplitude corresponding to one and three blades. The average value of acceleration severity (all frequencies are taken into account) is given in figure 8f. It can be observed that maximum severity levels are obtained for IAVF values close to 5-6% and then tend to decrease. It is believed that unsteady experimental results agree, at least qualitatively, with what have been obtained with the chosen numerical approach. This has also been experimentally pointed out in the conclusion of Kosyna's paper [2001] using unsteady measurements performed on the rotating impeller close to outlet radius. More deep analysis is in progress in order to extract more detailed informations in particular for lower flow rates.

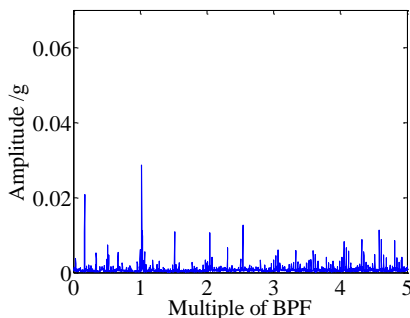

(a) IAVF=0 %

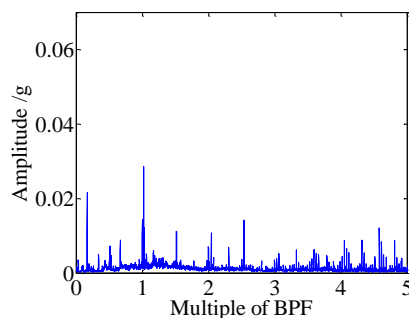

(b) IAVF=3%

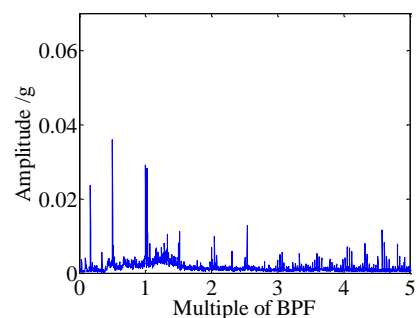

(c) IAVF= 5%

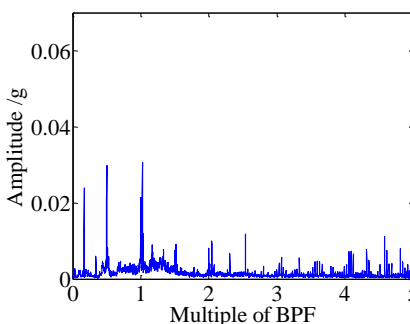

(d) IAVF=6 %

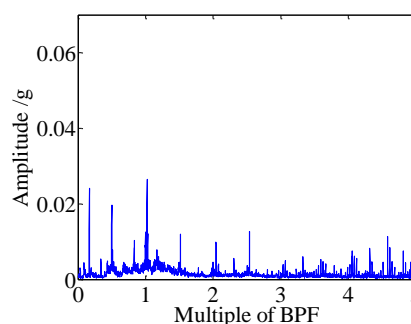

(e) IAVF=7%

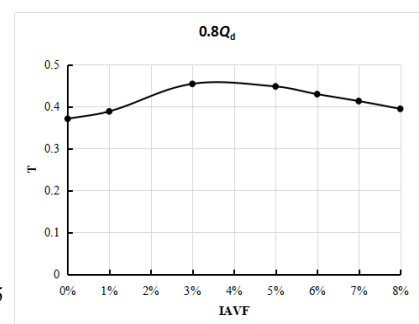

(f) Severity evolutions

Figure 8: FFT acceleration levels (X direction) for several IAVF values at $Q/Q_d=0.8$

V CONCLUSIONS

258 Experimental overall pump performances and dynamic characteristics have been performed
 259 under air-water two phase conditions for a centrifugal geometry. Local flow pattern inside the pump
 260 have been also obtained using CFD tools in order to explain the performance degradation when
 261 IAVF was increased. The main results are the following:

- 262 1. Pump performance degradation is more pronounced for low flow rates compared to high
 263 flow rates. The starting point of severe pump degradation rate is related a specific flow
 264 coefficient, which value corresponds to the change of the slope of the theoretical head curve.
- 265 2. Compared with existing experimental results for 2D impeller shapes, the present 3D
 266 impeller pump geometry head degradation is quite small (less than 1%) within IAVF values
 267 below 5% between $0.75Q_n$ and Q_n .
- 268 3. Local numerical results inside the impeller and volute passages give some explanation about
 269 this last point and describe the air-water flow pattern change just before the experimental
 270 pump breakdown. Particle fluid model with interface transfer terms looks quite suitable to
 271 evaluate pump performance degradation up to IAVF values of 7%.
- 272 4. Maximum experimental IAVF of 10% can be reached before pump breakdown only for
 273 initial inlet flow conditions close to best efficiency ones. Numerical approach always fails
 274 using high IAVF inlet conditions.
- 275 5. Pressure fluctuations are stronger when inlet void fraction increases with a maximum power
 276 value for 5% at blade passing frequency value and small flowrate would be given more low
 277 frequency characteristics. Maximum severity levels of vibration are obtained for IAVF
 278 values close to 5-6% and then tend to decrease.

VI NOMENCLATURE

280 b : impeller blade width

281 u : circular velocity

282 R : radius

283 n : rotational speed

284 p : static pressure

285 C_p : local pressure coefficient $C_p = \frac{p - \bar{p}}{0.5\rho u_2^2}$

286 H : pump head

287 Q : volume water flow rate

288 t : time

289 α : local air void fraction

290 φ : flow coefficient $\varphi = Q / (2\pi \cdot R_2 \cdot b_2 \cdot u_2)$

291 ρ : density of mixed fluid $\rho = \rho_{water} \times (1 - \alpha) + \rho_{air} \times \alpha$

292 ν : water cinematic viscosity

293 ω : angular velocity

294 η : global efficiency of the pump $\eta = \frac{\rho g Q_{water} H}{P}$

295 ψ : head coefficient $\psi = gH / (u_2)^2$

296 ψ_t : theoretical head coefficient $\psi_t = \psi / \eta$

297 Ω_s : specific speed $\Omega_s = \omega \cdot \frac{Q^{0.5}}{(gH)^{0.75}}$

298 Z : impeller blade number

299 BPF: blade passing frequency

300 d : design condition

301 IAVF: Inlet air void fraction $IAVF = \frac{Q_{air}}{Q_{air} + Q_{water}}$

302 T : vibration severity $T = \sqrt{\frac{1}{N} \sum_{k=1}^N X_k^2}$

303 *: result from FFT

304 VII ACKNOWLEDGEMENTS

305 The authors gratefully acknowledge the financial support by National Natural Science Foundation
306 of China (51509108), Natural Science Foundation of Jiangsu Province (BK20150516), China
307 Postdoctoral Science Foundation Funded Project (2015M581735, 2016T90422) and Senior Talent
308 Foundation of Jiangsu University (15JDG048).

309 VIII REFERENCES

310 Barrios, L., Prado, M. G. (2009). Modeling Two Phase Flow Inside an Electrical Submersible Pump Stage.
311 ASME 2009, International Conference on Ocean, Offshore and Arctic Engineering (Vol.133, pp.227-231).

312

313 Estevam, V., França, F.A., Alhanati, F.J.S., (2003), Mapping the Performance of Centrifugal Pumps under
314 Two- Phase Conditions, 17th International Congress of Mechanical Engineering, SaoPaulo.

315

316 **Gülich, I. J. F. (2014). Design of the Hydraulic Components. Centrifugal Pumps. Springer Berlin Heidelberg.**

317

318 Kosyna, G., Suryawijaya, P., Froedrichs, J., (2001), Improved Understanding of Two-Phase Flow Phenomena
319 Based on Unsteady Blade Pressure Measurements, Journal of Computational and Applied Mechanics, Vol. 2,
320 N1, pp. 45-52.

321

322 Minemura, K., Murakami, M., Katagiri, H., (1985). Characteristics of Centrifugal Pumps Handling Air-Water
323 Mixtures and Size of Air Bubbles in Pump Impellers, Bulletin of JSME, Vol. 28, N244, pp 2310- 2318.

324

325 Müller, T., (2015). Numerical 3D RANS Simulation of Gas-Liquid Flow in a Centrifugal Pump with an
326 Euler-Euler Two-Phase Model and a Dispersed Phase Distribution, 11th European Conference on
327 Turbomachinery Fluid dynamics & Thermodynamics, ETC11, March 23-27, ETC2015-076, Madrid.

328

329 Murakami, M., Minemura, K., (1974a). Effects of Entrained Air on the Performance of a Centrifugal Pump.
330 First report- Performance and Flow Conditions, Bulletin of JSME, Vol. 17, N.110, pp 1047-1055.

331

332 Murakami, M., Minemura, K., (1974b). Effects of Entrained Air on the Performance of a Centrifugal Pump.
333 Second Report- Effect of Number of Blades, Bulletin of JSME, Vol.17, N.112, pp 1286-1295.

334

335 Patel, B.R., Rundstadler, P.W., (1978). Investigation into the Two-Phase Behaviour of Centrifugal Pumps,
336 ASME Symposium on Polyphase Flow in Turbomachinery- San Francisco-USA.

337

338 Sekoguchi, K., Takada, S., Kanemori, Y. (1984). Study of Air-Water Two-Phase Centrifugal Pump by
339 Means of Electric Resistivity Probe Technique for Void Fraction Measurement: 1st Report, Measurement of
340 Void Fraction Distribution in a Radial Flow Impeller. Bulletin of JSME, Vol.27, N.227, pp 931-938.

341

342 Si, Q., Bois, G., Zhang, K., Yuan, S., (2017). Air-Water Two-Phase Flow Experimental and Numerical
343 Analysis in a Centrifugal Pump. Proceedings of 12th European Conference on Turbomachinery Fluid
344 Dynamics and Thermodynamics, ETC 12, Stockholm, April 3-7th