



Science Arts & Métiers (SAM)

is an open access repository that collects the work of Arts et Métiers Institute of Technology researchers and makes it freely available over the web where possible.

This is an author-deposited version published in: <https://sam.ensam.eu>
Handle ID: <http://hdl.handle.net/10985/16567>

To cite this version :

Antoine PIERQUIN, Thomas HENNERON, Stéphane CLENET, Stephane BRISSET -
Optimisation process to solve multirate system - Przegląd Elektrotechniczny - Vol. 1, n°6, p.56-59
- 2015

Any correspondence concerning this service should be sent to the repository

Administrator : scienceouverte@ensam.eu



doi:

Optimisation process to solve multirate system

Abstract. The modelling of a multirate system -composed of components with heterogeneous time constants- can be done using fixed-point method. This method allows a time-discretization of each subsystem with respect to its own time constant. In an optimisation process, executing the loop of the fixed-point at each model evaluation can be time consuming. By adding one of the searched waveform of the system to the optimisation variables, the loop can be avoided. This strategy is applied to the optimisation of a transformer.

Streszczenie.
()

Keywords: multirate modelling, waveform relaxation method, multidisciplinary optimisation
Słowa kluczowe:

Introduction

In the context of the optimisation of a multi-physic device, it is necessary to simulate several physics phenomena or several subsystems, and to couple them. For dynamic simulations, the coupling must be done dealing with time discretization which can be different from one subsystem to another. Moreover, if one or several systems have time consuming model, the coupling can lead to a global model all the more time consuming. But an optimisation process leads to a large number of evaluations of the device model. So the optimisation procedure will be even longer than the device model is time consuming. Multidisciplinary Optimization (MDO) considers the optimisation of multi-physic model with different approaches. For static problems, the MDO approaches have already been treated in [1, 2, 3]. On one hand, the Multidisciplinary Feasibility (MDF) concept is an optimisation process where the consistency of the global model is ensured at each evaluation by using an iterative process between the different subsystems (fixed-point, quasi-Newton, ...). On the other hand, to avoid performing the fixed-point loop and to incorporate more deeply the simulation into the optimisation process, the loop is broken and the consistency of the result is guaranteed by addition of constraints into the optimisation problem: this is the Individual Disciplinary Feasibility principle (IDF) [4, 5]. In the case of dynamic systems, the same procedure can be considered if the coupling is carried out by dynamic iteration, also called waveform relaxation method. So, an IDF strategy where waveforms are added to the optimisation variables is conceivable.

Consider an optimisation problem which requires modelling a multirate system - a system where subsystems have different time constants. An efficient way to model such a system is the Waveform Relaxation Method (WRM) [6, 7, 8], which is a fixed-point technique applied to waveforms. In this way, the model is coherent and its evaluation gives the correct behaviour of the multirate system. Performing the fixed-point loop at each iteration of the optimisation process could be time-consuming. This way of performing optimisation is the MDF principle. The IDF principle consists in avoiding the loop by adding the waveforms to the optimisation variables on one side, and constraints to ensure the consistency of the model on other side. The additional constraints correspond to the condition that the fixed-point process has to verify when the algorithm has converged.

Waveform Relaxation Method

Let us consider a system composed of several physic devices, each device having its own time dynamic: the system is said to be multiphysic and multirate. The system is split into r subsystems verifying for all $i \in \{1, \dots, r\}$ a differential

algebraic equation

$$(1) \quad \dot{\mathbf{y}}_i(t) = \mathbf{f}_i(\mathbf{y}(t), \mathbf{z}(t)),$$

$$(2) \quad \mathbf{g}_i(\mathbf{y}(t), \mathbf{z}(t)) = \mathbf{0},$$

with

$$t \in T = [t_0, t_f], \quad \mathbf{y}_i : T \rightarrow \mathbf{R}^{m_i}, \quad \mathbf{z}_i : T \rightarrow \mathbf{R}^{n_i},$$

$$\sum_{i=1}^r m_i = m, \quad \sum_{i=1}^r n_i = n,$$

$$\mathbf{y} = [\mathbf{y}_1, \dots, \mathbf{y}_r]^t, \quad \mathbf{z} = [\mathbf{z}_1, \dots, \mathbf{z}_r]^t,$$

$$\mathbf{f}_i : (\mathbf{R}^n, \mathbf{R}^m) \rightarrow \mathbf{R}^{m_i}, \quad \mathbf{g}_i : (\mathbf{R}^n, \mathbf{R}^m) \rightarrow \mathbf{R}^{n_i}.$$

The principle of the WRM is to perform a relaxation on the waveforms of the different subsystems. It produces iteratively an approximation $(\mathbf{y}^k, \mathbf{z}^k)$ of the exact solution (\mathbf{y}, \mathbf{z}) . Several relaxation schemes exist; we present here the Gauss-Seidel scheme. At each iteration k , the following subsystems are solved sequentially:

$$(3) \quad \begin{aligned} \dot{\tilde{\mathbf{y}}}_i^k(t) &= \mathbf{f}_i(\tilde{\mathbf{y}}_i^k(t), \tilde{\mathbf{z}}_i^k(t)), \\ \mathbf{g}_i(\tilde{\mathbf{y}}_i^k(t), \tilde{\mathbf{z}}_i^k(t)) &= \mathbf{0}, \end{aligned}$$

where $\tilde{\mathbf{y}}_i^k = [\mathbf{y}_1^k, \dots, \mathbf{y}_{i-1}^k, \mathbf{y}_i^k, \mathbf{y}_{i+1}^{k-1}, \dots, \mathbf{y}_r^{k-1}]$ and $\tilde{\mathbf{z}}_i^k = [\mathbf{z}_1^k, \dots, \mathbf{z}_{i-1}^k, \mathbf{z}_i^k, \mathbf{z}_{i+1}^{k-1}, \dots, \mathbf{z}_r^{k-1}]$. The iterative process stops when the difference between two iterates is small enough, i.e. when $\left\| \begin{matrix} \mathbf{y}^k - \mathbf{y}^{k-1} \\ \mathbf{z}^k - \mathbf{z}^{k-1} \end{matrix} \right\|$ is less than a given tolerance.

So the WRM appears to be a fixed-point process: indeed, if we denote by Φ the operator that gives the iterate k from the previous iterate $k-1$, we have that

$$(4) \quad (\mathbf{y}^k, \mathbf{z}^k) = \Phi(\mathbf{y}^{k-1}, \mathbf{z}^{k-1}).$$

The Φ -operator represents the sequential solver of the r subsystems (3), with the waveforms \mathbf{y}^{k-1} and \mathbf{z}^{k-1} as sources, and \mathbf{y}^k and \mathbf{z}^k as solutions.

Now, we want to have

$$(5) \quad (\mathbf{y}^k, \mathbf{z}^k) = (\mathbf{y}^{k-1}, \mathbf{z}^{k-1}),$$

equivalent to

$$(6) \quad (\mathbf{y}^{k-1}, \mathbf{z}^{k-1}) = \Phi(\mathbf{y}^{k-1}, \mathbf{z}^{k-1}).$$

So the WRM solves the fixed-point problem

$$(7) \quad \Phi(\chi) = \chi, \quad \text{with } \chi = (\mathbf{y}, \mathbf{z}).$$

However, equations (3) are typically solved in time by application of discrete schemes (Euler, Runge-Kutta, ...). So the fixed-point condition is expressed onto the discrete waveforms

$$(8) \quad y_i^k = [y_i^k(t_1^i), y_i^k(t_2^i), \dots, y_i^k(t_{N_i}^i)]^T$$

and

$$(9) \quad z_i^k = [z_i^k(t_1^i), z_i^k(t_2^i), \dots, z_i^k(t_{N_i}^i)]^T,$$

where $(t_n^i)_{n=1}^{N_i}$ is the time discretization associated with the i -th subsystem. Finally, the variable χ is formed by the set of all the discretized waveforms.

Let us consider that a model simulated by WRM is used for an optimisation; then, at each evaluation of the model, the subsystems from $i = 1$ to r are solved at each iteration k until that convergence is effective. If we denote by K the minimum number of iterations required to obtain convergence, each subsystem has to be solved at least K times per model evaluation.

Multidisciplinary optimisation

At each evaluation of a WRM modelling, subsystems are solved several times on the time-domain $T = [t_0, t_f]$ during the loop. At the end of the loop, the fixed-point criterion $\Phi(\chi) = \chi$ is satisfied. The idea of the IDF is to avoid performing this loop during the optimisation process. At each evaluation of the model, subsystems are solved only one times; consistency of the final result is assured by the optimisation process by adding the fixed-point condition $\Phi(\chi) = \chi$ to the constraints.

Let us consider the optimisation problem

$$(10) \quad \tilde{x} = \arg \min_x f(x) \quad \text{such that} \quad k_f(x) \leq 0.$$

Suppose that evaluation of f or k_f requires evaluating a multirate system. The modelling of this system can be done by using WRM. But we saw that it will imply to solve K times each subsystem per evaluation of the model. IDF suggests to add variables and constraints to the optimisation problem, to not perform the loop: the discrete waveforms χ are now a part of the optimisation variables, and the relation $\Phi(\chi) = \chi$ a part of the constraints. More precisely, the values $y_i^0(t_n^i)$ and $z_i^0(t_n^i)$ for $n = 1$ to N_i are transformed into optimisation variables. Likewise, the constraints must verify $y_i^0(t_n^i) = \Phi(y_i^0(t_n^i))$ and $z_i^0(t_n^i) = \Phi(z_i^0(t_n^i))$. The IDF problem is expressed as follow:

$$(11) \quad \begin{aligned} (\tilde{x}, \tilde{\chi}) &= \arg \min_{(x, \chi)} f(x, \chi) \\ \text{such that} \quad &\begin{cases} k_f(x, \chi) \leq 0, \\ \Phi(\chi) - \chi = 0. \end{cases} \end{aligned}$$

By this way, Φ is evaluated only once per model evaluation during the solve of (11) (Fig. 2); whereas in the problem (10), WRM implies to evaluate Φ until convergence of the fixed-point iteration (Fig. 1).

However, the number of optimisation variables is strongly increased and we have to deal with a curse of dimensionality. But when a Gauss-Seidel scheme is used and the time-discretization is different, it could be possible to add only the waveforms with the least points to the optimisation variables.

If the number of evaluations of the Φ -operator seems to be reduced with the IDF formulation, the high number of optimisation variables can have the opposite effect. Indeed, the resolution of problem (11) can required a number of calls to

the model very superior to the resolution of the problem (10). Then, the Φ -operator evaluations number could be greater with the IDF formulation than with the MDF one. It will be particularly true for the gradient-based optimisation methods with a gradient computed by finite differences.

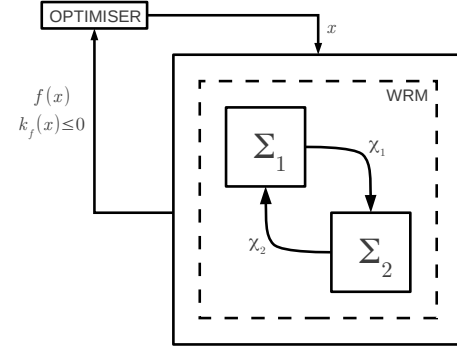

Fig. 1. Optimisation with WRM modelling

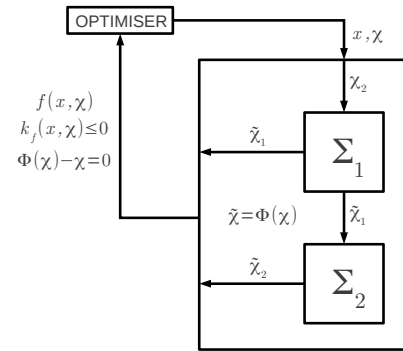

Fig. 2. Optimisation with IDF

Application

We study a device formed by an LC filter supplying the primary coil of a transformer (Fig. 3). The dynamic of the voltage and current into the transformer is not the same than in the filter. So this device can be split into two parts with time-constants very different: the filter forms a first subsystem and the transformer a second. The coupling and the modelling are done by waveform relaxation method by introducing voltage and current sources. The filter is a voltage source, an inductor, a capacitor and a current source; the second subsystem is composed of a voltage source, a resistor and a transformer. The current source of the first subsystem is the current i_R in the primary coil of the transformer, and the voltage source of the transformer is the voltage v_c of the capacitor (Fig. 4). The voltage source v is a combination of sinus waveforms at frequencies of 50 Hz and 20 kHz. The time-step of the Euler scheme is $dt_1 = 5.10^{-7}$ s in the first subsystem, and $dt_2 = 1.10^{-3}$ s in the second.

The transformer is modeled with a 2D Finite Element Method (FEM): we use the A-formulation to express the magnetic induction. The expression

$$(12) \quad B = \text{curl}A$$

is introduced into the equations

$$(13) \quad \text{curl}H = J,$$

$$(14) \quad \text{div}B = 0.$$

Voltage is imposed by the coupling equation [9]

$$(15) \quad \frac{d}{dt} \left(\int_D \mathbf{A} \cdot \mathbf{N} dv \right) + R \cdot i_R = v_c.$$

After a space discretization of the magnetic vector potential \mathbf{A} using edge shape functions [10], we obtain the following matrix system to solve:

$$(16) \quad M \dot{\mathbf{X}} + P \mathbf{X} = \mathbf{V}.$$

The system is then solved by using an implicit Euler time-scheme discretization. The circuit equations of the filter form a small matrix system also solved in time by an Euler scheme.

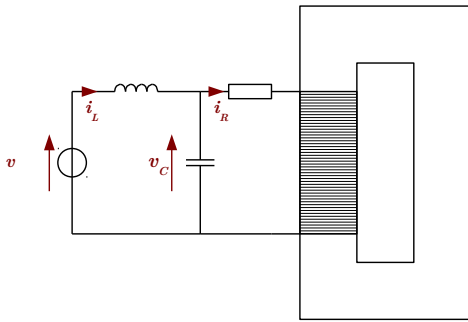

Fig. 3. Complete device of the circuit and the transformer

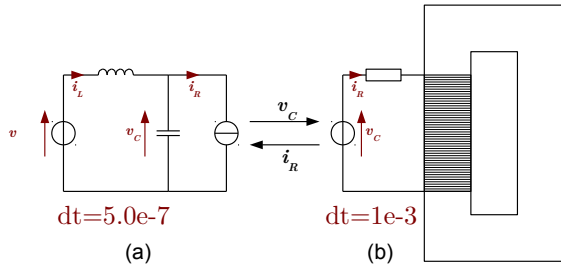

Fig. 4. Split device: circuit and transformer parts

We want to minimize the transformer mass m and fix the root mean square (RMS) current i_{rms} in the transformer's coil. The transformer geometry is entirely defined by its height H and its width L (Fig. 5). To obtain RMS current, the model is simulated on several periods until the steady state is achieved.

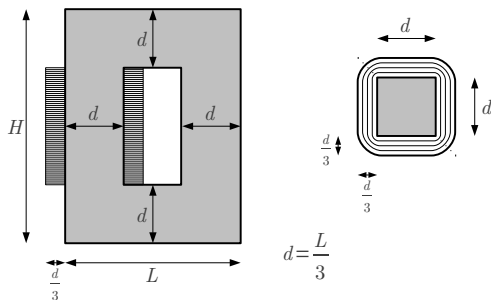

Fig. 5. Transformer's geometry.

The problem to solve is the following:

$$(17) \quad \begin{cases} \min_{H,L} m(H, L), \\ 20\text{cm} \leq H \leq 40\text{cm}, \\ 12\text{cm} \leq L \leq 24\text{cm}, \\ H - \frac{2L}{3} > 0, \\ i_{rms} = 3 \text{ A}. \end{cases}$$

In this case, i_{rms} is obtained by modelling the device on a time-domain $T = [t_0, t_f]$ by WRM. With an IDF strategy, the problem to solve becomes

$$(18) \quad \begin{cases} \min_{H,L,i_R} m(H, L, i_R), \\ 20\text{cm} \leq H \leq 40\text{cm}, \\ 12\text{cm} \leq L \leq 24\text{cm}, \\ H - \frac{2L}{3} > 0, \\ i_{rms} = 3 \text{ A}, \\ \Phi(i_R) = i_R. \end{cases}$$

In the MDF case, at each iteration k of the fixed-point (WRM) loop, i_R^{k-1} is a source for the first subsystem Fig. 4 (a), that is solved and gives v_c^k . From v_c^k as voltage source, the transformer subsystem Fig. 4 (b) is solved to obtain $i_R^k = \Phi(i_R^{k-1})$, and the loop continues until convergence, i.e. consistency. In the IDF case and for a sequential resolution of the subsystems, it is not necessary to give the voltage and the current as input waveforms, but only the current i_R . The current is imposed to the filter which computes the voltage v_c . Then v_c is imposed to the transformer's coil to obtain the current $\tilde{i}_R = \Phi(i_R)$. So i_R will be a part of the optimisation variables, and the relation $\tilde{i}_R = i_R$ will be added as a constraint of the optimisation problem.

The size of the optimisation variables is raised, but the optimisation process will deal with the consistency constraint, there is no fixed-point loop anymore. The current i_R is discretized in time with 100 points, so IDF problem has 102 optimisation variables: H, L, i_R . Fig. 6 to 8 present the results of the optimisation for the MDF (17) and IDF (18) problems from the same initial points for the geometry variables. The current i_R is always initialized to 0, for the first iterate of the WRM or for the initial optimisation variables. We use a Sequential Quadratic Programming (SQP) for the optimisations but we consider that gradient of the function is available, and so there is no estimation of the gradient by finite differences. The IDF optimisation converges for all points to a solution very close to the solution of MDF problem, as shown in Fig. 6 for the optimal variables and for the optimal mass. Fig. 7 shows that the number of iterations done by SQP algorithm is quite similar for both formulation, but the number of evaluations of the Φ -operator is more important in the case of MDF formulation (Fig. 8). Indeed, only one evaluation is performed by iteration for IDF optimisation, whereas at least 6 evaluations are necessary for MDF optimisation. So if the gradient is available at a computing time similar to the model's one, IDF could allow performing an optimisation in a shorter time than the classic MDF formulation.

Conclusion

The waveform relaxation method is a fixed-point process that allows simulating multirate system. But the fixed-point loop to ensure the model consistency can be time consuming. If the model is used in an optimisation process, this loop can be avoided by adding some optimisation variables and by considering the fixed-point criterion as a constraint of the

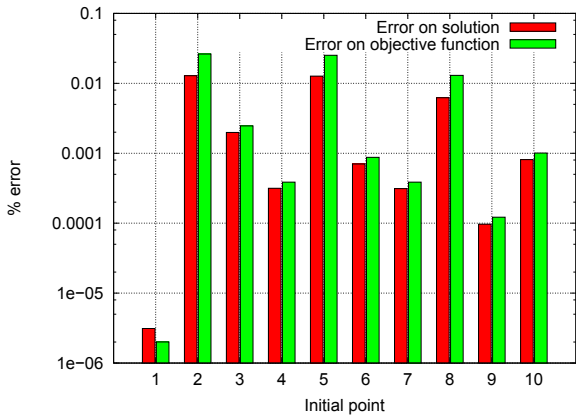

Fig. 6. Error between optimal solutions $\frac{\|x_{IDF} - x_{MDF}\|}{\|x_{MDF}\|}$ and between optimal outputs $\frac{\|m_{IDF} - m_{MDF}\|}{\|m_{MDF}\|}$

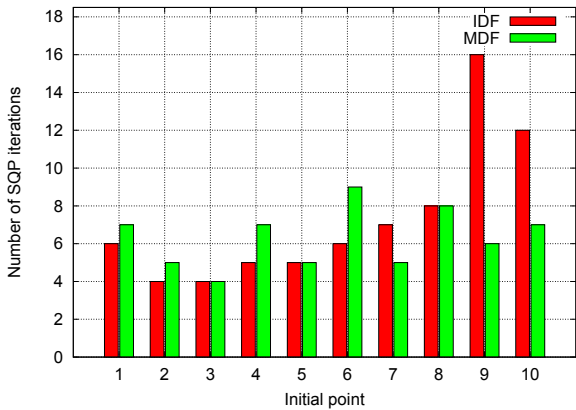

Fig. 7. Number of SQP iterations

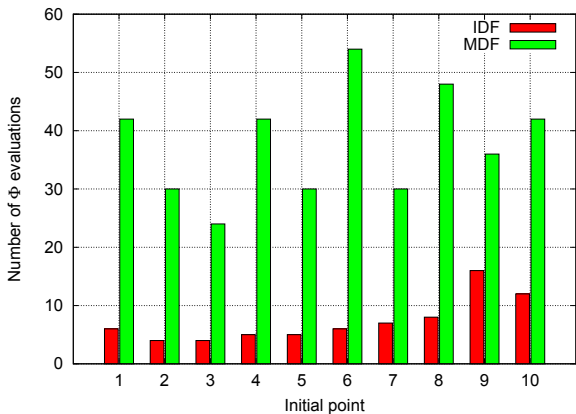

Fig. 8. Number of evaluations of the Φ -operator

optimisation problem: this is the individual disciplinary feasibility optimisation extended to the dynamic case. If the gradient of the WRM operator could be obtained quickly, IDF could accelerate the optimisation process as shown on the optimisation of a transformer supplied by an LC filter, even with gradient-based optimisation method.

REFERENCES

- [1] J. Sobieszczanski-Sobieski and R.T. Haftka. Multidisciplinary aerospace design optimization: survey of recent developments. *Structural optimization*, 14:1–23, 1997.
- [2] R. D. Braun and I. M. Kroo. Development and application of the collaborative optimization architecture in a multidisciplinary design environment. In *Multidisciplinary Design Optimization: State of the Art*, pages 98–116. SIAM, 1997.
- [3] R. Ben-Ayed and S. Brisset. Improvement of output space mapping by using multidisciplinary optimization formulations. COMPEL, march 2011.
- [4] S. Kreuawan, F. Gillon, and P. Brochet. Optimal design of permanent magnet motor using multidisciplinary design optimization. In *Electrical Machines, 2008. ICM 2008. 18th International Conference on*, pages 1–6, 2008.
- [5] E. Cramer, J. Dennis, Jr., P. Frank, R. Lewis, and G. Shubin. Problem formulation for multidisciplinary optimization. In *SIAM Journal on Optimization*, vol. 4, no. 4, pp. 754–776, 1994.
- [6] M.L. Crow and M.D. Ilic. The waveform relaxation method for systems of differential/algebraic equations. In *Decision and Control, 1990., Proceedings of the 29th IEEE Conference on*, pages 453–458 vol.2, dec 1990.
- [7] E. Lelarasmee, A.E. Ruehli, and A.L. Sangiovanni-Vincentelli. The waveform relaxation method for time-domain analysis of large scale integrated circuits. *Computer-Aided Design of Integrated Circuits and Systems, IEEE Transactions on*, 1(3):131–145, july 1982.
- [8] S. Schops, H. De Gersem, and A. Bartel. A cosimulation framework for multirate time integration of field/circuit coupled problems. *Magnetics, IEEE Transactions on*, 46(8):3233–3236, aug. 2010.
- [9] F. Piriou and A. Razek. Finite element analysis in electromagnetic systems-accounting for electric circuits. *Magnetics, IEEE Transactions on*, 29(2):1669–1675, 1993.
- [10] Alain Bossavit. A rationale for 'edge-elements' in 3-d fields computations. *Magnetics, IEEE Transactions on*, 24(1):74–79, 1988.

Authors: Ph.D. Antoine Pierquin, Associate Prof. Stéphane Brisset, EC Lille, L2EP (Laboratory of Electrical Engineering and Power Electronics), Cité Scientifique CS 20048, 59651 Villeneuve d'Ascq, France, email: ant.pierquin@gmail.com; Associate Prof. Thomas Henneron, Université de Lille 1, L2EP, Cité Scientifique, Bâtiment P2, 59655 Villeneuve d'Ascq, France; Prof. Stéphane Clénet, Arts et Métiers Paris-Tech, L2EP, 8 Boulevard Louis XIV, 59046 Lille, France.