



Science Arts & Métiers (SAM)

is an open access repository that collects the work of Arts et Métiers Institute of Technology researchers and makes it freely available over the web where possible.

This is an author-deposited version published in: <https://sam.ensam.eu>
Handle ID: <http://hdl.handle.net/10985/24547>

To cite this version :

David URIBE, Camille DURAND, Cyrille BAUDOUIN, Pierre KRUMPIPE - Towards the Real-Time Piloting of a Forging Process: Development of a Surrogate Model for a Multiple Blow Operation - In: 14th International Conference on the Technology of Plasticity (ICTP 2023), France, 2023-09-24 - Proceedings of the 14th International Conference on the Technology of Plasticity - Current Trends in the Technology of Plasticity - 2023

Any correspondence concerning this service should be sent to the repository

Administrator : scienceouverte@ensam.eu



Towards the Real-Time Piloting of a Forging Process: Development of a Surrogate Model for a Multiple Blow Operation

David Uribe¹(✉), Camille Durand¹, Cyrille Baudouin¹, Pierre Krumpipe²,
and Régis Bigot¹

¹ HESAM Université, Arts et Métiers Institute of Technology, Université de Lorraine, LCFC,
Metz F-57070, France

{david_santiago.uribe_espitia,camille.durand}@ensam.eu

² Technical Centre for Mechanical Industry, CETIM, Saint-Etienne, France

Abstract. Forging processes are defined by variables related to the workpiece, the tools, the machine, and the process itself, and these variables are called process variables. They have a direct impact on the quality of the finished product, so it is important to accurately define them at the very beginning of the process design. Nowadays, the design stage is supported by numerical simulations, however, these simulations are made under ideal process conditions and do not consider the dynamics of the forging machine or the variabilities that may occur in production (e.g., variabilities in the dimensions of the billet). This suggests that among the different process variables, those defined for piloting the process (such as the blows energies, for example) are fixed under nominal conditions and are not calibrated for each part produced.

This study exploits a methodology in four steps to create a surrogate model and implement it into a machine-behavior model for real-time piloting of a forging operation with a screw press. This model supports the piloting of the operation, providing a value for the energy setpoint, according to the current state of process variables, these being the input of the model. The methodology is detailed for a multiple-blow cold upsetting of a copper billet.

Keywords: Forging · Real-time prediction · Surrogate model · Numerical simulation · Mass-spring-damper model

1 Introduction

Ensuring high precision and consistency in piloting a forging process can be challenging due to the complex nature of such forming processes. While numerical simulations can predict key forging outcomes, such as billet's deformation behavior and forging load, they often fail to consider the dynamic of the forging press and its interaction with the workpiece. The lack of consideration for these dynamics in simulations can lead to discrepancies between the predicted and actual process outcomes, as the dynamic affects the efficiency of the blows and some other variables, such as forging load or ram displacement [1–4].

Various approaches have been explored in the literature for representing the dynamics of forging machines, ranging from the finite element method approach for the machine to methods like multi-body systems and mass-spring-damper systems [1, 5–10]. These models have been coupled to numerical simulations of the forging process to capture the interactions between the machine and the workpiece [11]. However, coupling these models with forging simulations can be computationally expensive and time-consuming, which limits their effectiveness for real-time control and optimization of the forging process.

Surrogate models have emerged as a promising alternative to simulations in such cases. A surrogate model is a simplified representation of the original system that can reproduce its key features with lower computational cost and higher speed [12]. While simulations provide accurate predictions of systems behaviors, surrogate models offer the advantage of faster and more cost-effective predictions with acceptable accuracy. While surrogate models have been extensively tested in various manufacturing processes [13–16], their application in forging is limited. Moreover, there is a lack of research on the coupling of these surrogate models and the machine models presented before. Therefore, this study develops a methodology to create a surrogate model predicting the billet behavior (load-displacement curve) in a multiple-blow forging operation and coupling it with a mass-spring-damper machine model. This coupling allows real-time prediction of the billet-interface-machine behavior giving a corrected energy setpoint for piloting the process.

The requirements of the model are responsiveness, fidelity, and predictivity. The responsiveness is achieved using surrogate modeling techniques. The predictivity is ensured by using calibrated numerical simulations for the surrogate model training and the fidelity is enabled by using real operation conditions as the variabilities of the process are considered.

The proposed methodology has four steps: Realization of a parametric sensitivity study to determine the process dominant variables. Creation of a database with the help of optimized numerical simulations. Training and validation of the surrogate model. And, coupling of the surrogate model to a mass-spring-damper model of the press. This methodology is detailed for one case: a multiple-blow cold upsetting of a copper billet.

2 Surrogate Modeling Design

2.1 Experimental Setup and Numerical Modeling

The forging operation studied is a cylindrical copper billet's multiple blow cold upsetting. The billet is forged with the LASCO SPR400 screw press of the VULCAIN platform at Arts et Métiers Metz in France (see Fig. 1). This press can provide a maximum forging energy of 28,9 kJ for a ram speed of 680 mm/s. The press is controlled by a setup energy adjustable from 1% to 100% of its maximum capacity. Tools with smoothed flat dies were used for the upsetting operations.

For this operation, a cylindrical pure copper billet defined by its Initial Diameter (ID) and Initial Height (IH) is forged at room temperature along its revolution axis n times until it reaches a Final Height (FH- n), passing by intermediate Final Heights (FH1, FH2...). The resulting upsetting part is usually a preform for other forging processes,

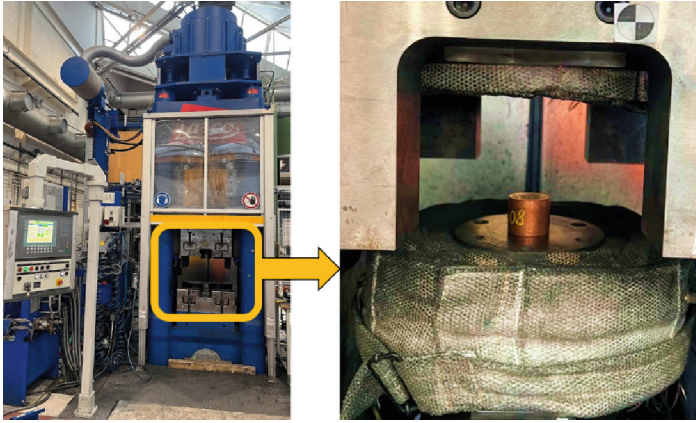

Fig. 1 Experimental setup: screw press overview and focus on the flat dies and the billet.

such as ring rolling for billet with large dimensions. The final height of the upset is a crucial factor as it influences the load and energy required for subsequent operations, such as piercing and ring rolling [17]. Controlling the final height of the upsetting part means knowing the forging energy setup for each blow, considering the workpiece's initial, actual, and final status (See Fig. 2).

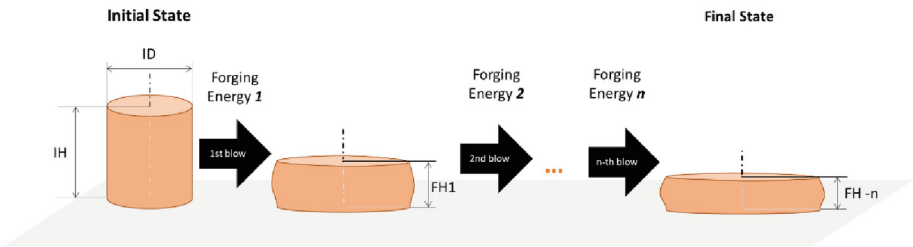

Fig. 2 Multiple-blow upsetting: workpiece schematic.

The correspondent process is modeled using FORGE NxT® the Finite Elements software from Transvalor. A rigid die 2D axisymmetric simulation is performed (see Fig. 3). A reduced Hensel-Spittel law for the copper rheology has been extracted from [18]. Other numerical parameters (friction law, heat transfer coefficients, etc.) are taken from the literature [19, 20].

Comparing the simulation results with the ones coming from the experimental test should allow the validation of the model. If the simulation results do not match the experimental ones, some optimization techniques should be followed to calibrate the numerical parameters, as proposed by [21, 22] and deployed by [18].

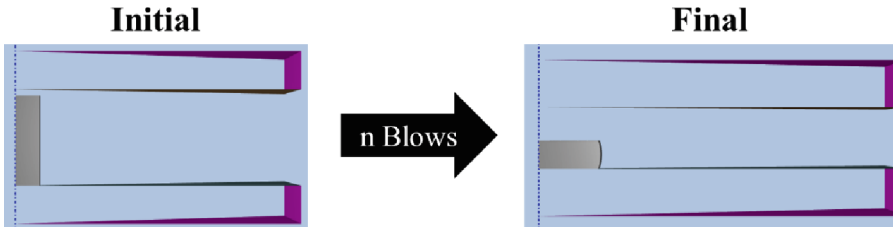

Fig. 3 Multiple-blow cold upsetting of a cylindrical copper billet: numerical simulation

2.2 Sensitivity Analysis and Database Creation

A parametric sensitivity analysis (SA) is performed based on the calibrated numerical simulation. The SA allows the identification of the most significant variables impacting the selected outputs of the system (final height, maximum load) and it also allows the determination of how these most impacting variables contribute to the overall behavior of the forging operation [23, 24]. With this knowledge, the creation of the surrogate model is optimized by focusing on the most influential variables. To do that, dimensionless local sensitivity analysis techniques were chosen for their simplicity. Figure 4 shows the sensitivity analysis results: The sensitivity percentage value is compared for every parameter, supporting the surrogate model's architecture choice.

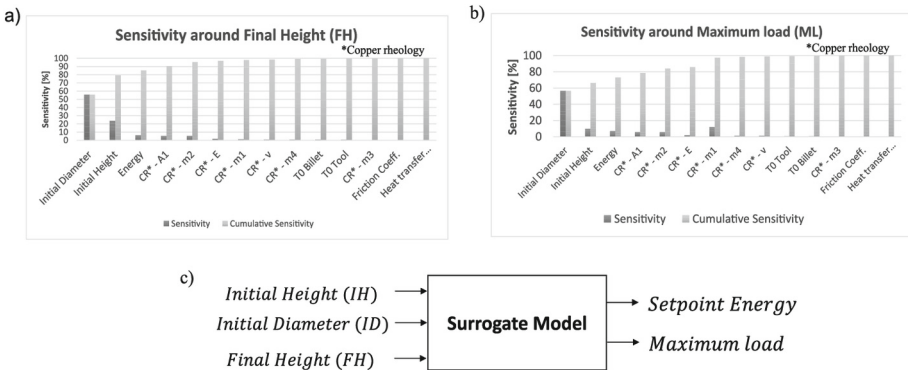

Fig. 4 a) Sensitivity analysis of initial parameter on final height. b) Sensitivity analysis of initial parameter on maximum load. c) Model's architecture choice deduced from the sensitivity analysis.

Once the inputs and outputs of the model are chosen, a full factorial design of experiments of five levels is defined, with the variables range determined thanks to operational data. For our case, 150 simulations were computed.

2.3 Creation of the Surrogate Model

The given architecture of the surrogate model leads to scalar predictions (Energy, Maximum load). Artificial neural networks have been chosen given their capabilities in

forming processes [15, 25–27]. The creation of the model involves two main steps: specifying the architecture of the network and training the network with the database. First, regarding the architecture of the network, the number of neurons in the hidden layers was estimated with the equation proposed by [28]:

$$h = \frac{\text{Number of Training Sets}}{10(m + n)} \quad (1)$$

where h is the number of neurons in the hidden layers, m is the number of neurons in the input layer, and n is the number of neurons in the output layer. In our case, the initial architecture should have more than forty neurons in its hidden layers.

Regarding the training of the network, the default activation function is the rectified linear unit function (ReLU) for the hidden layers and the linear function for the output layer [29]. The mean squared error (MSE) is the default loss function for training regression problems [30].

The simulation's initial dataset is normalized and divided into training, validation, and test data sets. A later experimental validation is also performed. The model is developed in Python programming language using Keras API.

The evaluation of the model requires three input values: Initial Height (IH), Initial Diameter (ID), and Final Height (FH), and predicts the energy setpoint and the maximum load for the operation (Fig. 4). The computation time is lower than 200ms. For a set of input points (IH, ID, FH), if the model is iteratively evaluated with $FH = [IH, FH]$, a set of points representing the current height-maximum load relationship, i.e., the load-displacement representation can be obtained/deduced (see Fig. 5). An energy-height curve could also be extracted for the same evaluation.

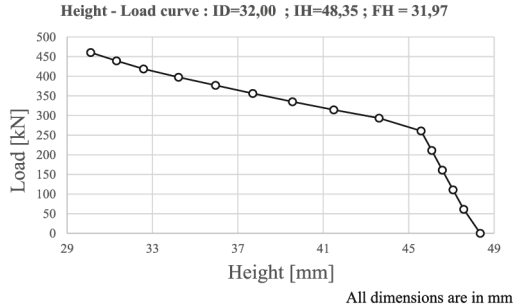

Fig. 5 Load-height curve obtained from an iterative evaluation of the surrogate model $FH = [IH, FH]$.

3 Billet-Interface-Machine (BIM) Model and Surrogate Model Integration

The surrogate model allows the prediction of the energy setpoint, which corresponds to the plastic energy in our numerical model with rigid dies (see Fig. 3).

However, this model lacks predictivity in a multiple-blow operation since it does not consider the blows' efficiency, which decreases after each forging step [19]. In the forging sequence, the energy transmitted by the press will be higher than the plastic energy transferred to the billet.

To determine the blow efficiency, one should model the billet, the machine-specific dynamic behavior, and their interactions, as done by [10], where a mass-spring-damper model (denoted BIM model) is used for the LASCO SPR400 screw press and could also be applied to other forming machines [1]. Using this BIM model, the total energy could be deployed in five energies: the kinetic of the masses, the elastic energy stored by the springs, the damping energy dissipated by the dampers, the friction energy between tools and billet, and the plastic energy absorbed by the billet. (Fig. 6)

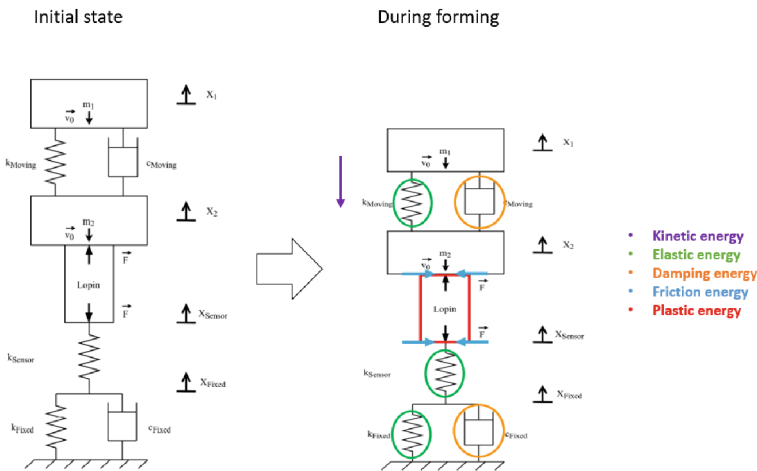

Fig. 6 Billet-Interface-Machine model for the screw press. Edited from [10]

During a blow, the kinetic energy, being the available energy at the beginning of the process, decreases as the ram transmits its equivalent energy to the rest of the system. It means that kinetic energy is transformed into the other four types of energy. For the calculation, the BIM model needs access to the billet's forging load for a given displacement. A numerical [10] and an analytical model [1] have been proposed to obtain this load-displacement curve.

Coupling the BIM and the surrogate models should allow a high-fidelity real-time prediction of the final height, the maximum load, and the blow efficiency for a multiple-blow operation.

The surrogate load-displacement curve obtained from the surrogate model is the input of the BIM model, which will give a real-time prediction of the blow's final heights (FH_1, FH_2, \dots, FH'), the blow's efficiencies, and a corrected load-displacement curve (see Fig. 7).

The final height FH used in the surrogate model is a target. The FH' is the predicted final height after the energy dissipation. Thus, FH will be lower than FH' .

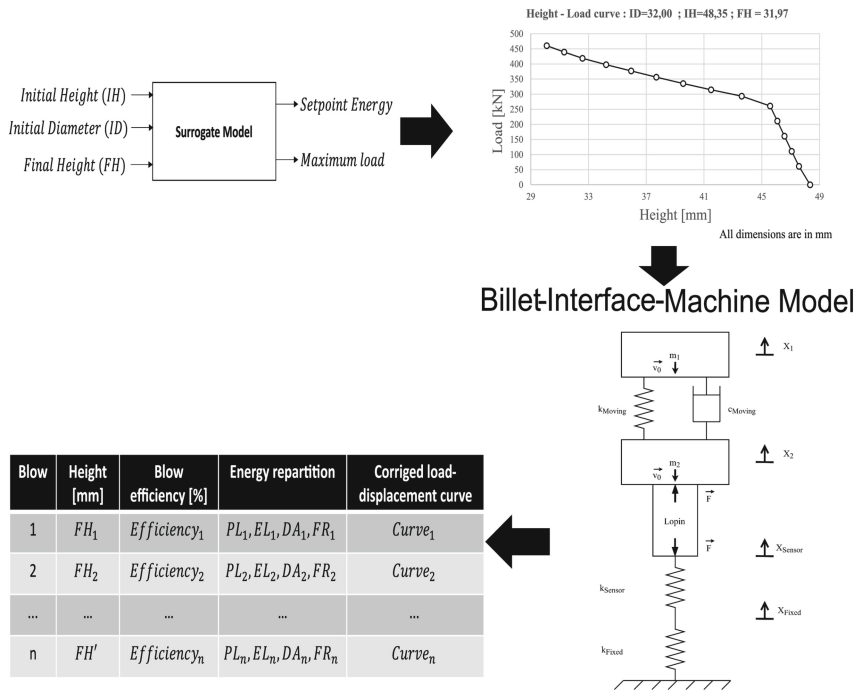

Fig. 7 Integration of the surrogate model in the BIM model (PL = Plastic, EL = Elastic, DA = Damping, FR = Friction).

4 Results

An experimental campaign is carried out to validate the multiple blow predictivity of the model. The model is trained using billets with $ID = [15, 20, 25, 30, 35]$ mm, whereas the billets out of the training set with $ID = 18$ mm, and $ID = 32$ mm were forged. Each billet has been forged four times. The $ID = 32$ mm was forged at 20% of the maximal press energy (5.780kJ). The $ID = 18$ mm was forged at 5% of the maximal press energy (1.445kJ). The load-displacement curves fit with the experimental data, and the prediction of the billet's heights has an error below 5%, corresponding to 0.6 mm (see Fig. 8). The prediction of the blow efficiency was also evaluated with errors below 5% (see Table 1).

Table 1. Blow efficiency and energy repartition: the gap between experimental and predicted data. (EL = Elastic, DA = Damping, FR = Friction).

Billet	Blow	Blow efficiency [%]		Error	Energy repartition: Surrogate + BIM		
		Experimental	Surrogate + BIM		EL [%]	DA [%]	FR [%]
ID = 32,00 IH = 48,24	1	98,56%	98,79%	0,23	0,49%	0,11%	0,61%
	2	96,20%	97,27%	1,07	1,22%	0,48%	1,40%
	3	89,23%	93,59%	4,36	4,99%	0,56%	1,05%
	4	85,75%	86,87%	1,12	11,71%	0,72%	0,70%
ID = 18,00 IH = 35,92	1	98,73%	99,45%	0,72	0,20%	0,04%	0,31%
	2	95,65%	98,61%	2,96	0,71%	0,26%	0,42%
	3	94,81%	96,36%	1,55	2,91%	0,38%	0,35%
	4	91,44%	92,63%	1,19	6,79%	0,44%	0,14%

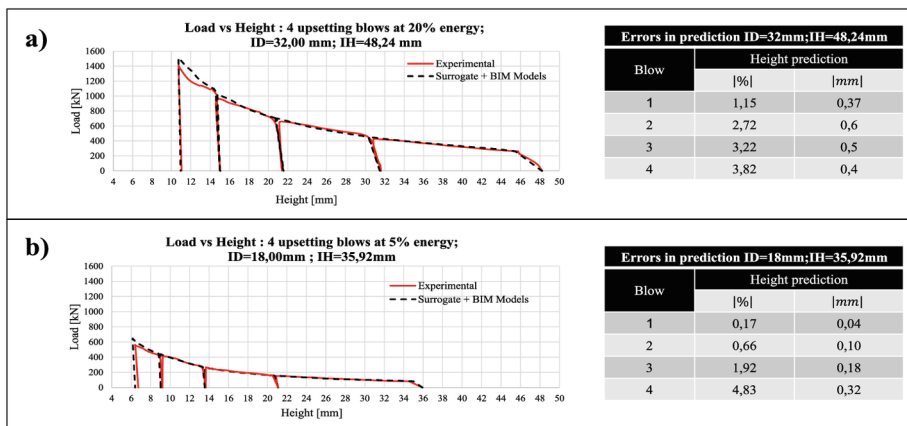

Fig. 8 Load-displacement curves: experimental and surrogate + BIM model and error in the prediction of the heights. a) billet with ID = 32,00 mm; IH = 48,24 mm. b) billet with ID = 18,00 mm; IH = 35,92 mm.

5 Discussion

The coupled model has been evaluated in a four-time blow upsetting operation and compared to experimental results (see Fig. 8). The training of the model being made for the range ID = [15–35], two billets near the training limits have been tested ID = [18;32].

The model allowed the prediction of both the intermediate heights and maximum loads of the blows, using load-displacement curves. Additionally, the model estimated the efficiency of the blows, as well as their energy repartition.

The load-displacement curves prediction is representative of the actual process, with all the curves nearly overlapping (see Fig. 8). However, these predictions show better results for the first blow: errors increase from less than 1% in the 1st blow to almost 5% in the 4th blow for final height prediction and from 5% to almost 9% in maximum load prediction. This can be explained by different factors: first, an error occurs in the prediction of the first blow and this error propagates with the increasing number of blows. In addition, we are approaching the training limits of the model, since the strain is increasing considerably (from 0 to 1.8 on average). Finally, the model has its limitations, since only three input variables are taken for training (ID, IH, FH). For a more robust and performant model, more process variables should be integrated, such as the billet's temperature, work hardening, geometry, or the press ram velocity.

The press's behavior has already been integrated into previous studies to calculate the blows' efficiency. However, in those cases, the data was taken from numerical [10] or analytical [1] models and integrated post hoc into the BIM model. Whereas in our case, the predictive surrogate model allows a calculation of the efficiency a priori in less than 30 s (see Table 1).

According to Table 1, the distribution of energy aligns with previous findings in the literature regarding copper upsetting using a screw press [10], where the elastic energy increases considerably after each blow, and the friction energy increases until it finds its maximum in the first blow, and then decreases as the compression ratio (IH/FH) and the blow efficiency decreases. As for the energy dissipated by damping, it is slightly increasing and less representative compared to the other two dissipated energies.

6 Conclusions and Perspectives

The methodology proposed in this study integrates a surrogate model in a billet-interface-machine (BIM) model. The surrogate model predicts the load-displacement behavior for a forged billet. This behavior is taken by the BIM model, which simulates its interaction with the machine for a given number of blows. The BIM model returns a corrected load-displacement curve, in which the intermediary heights and maximum loads for each blow can be extracted, as well as the blows' efficiency and energy distribution. The latter is divided into plastic, elastic, damped, and friction energy.

The prediction of the intermediate heights and the efficiency of the blows allow piloting the forging operation under the screw press, knowing the energy setpoint required to reach the desired final part.

The surrogate model's architecture has been defined thanks to the results of a parametric sensitivity analysis. The surrogate chosen is an artificial neural network multilayer perceptron that has been trained with a database provided by a calibrated numerical simulation. The results obtained from the model are consistent with the observations recorded in the literature. Consequently, the following conclusions were deduced:

1. The coupling of the surrogate and machine behavior model works as a decision-making tool for real-time piloting of the machine during a forging process. In the case of upsetting, the model's input parameters are the Initial Height, Initial Diameter, the number of blows, and the Final Height (a target). The outputs are the energy setpoint,

- the blows efficiency, the energy repartition, and the load-displacement curves, from which the final height and the maximum load for each blow can be extracted.
2. A further surrogate model should integrate more process variables, such as the billet's temperature, work hardening, and geometry. This would improve the performance of the model and its robustness.

Acknowledgments. We would like to express our sincere thanks to CETIM for their financial support in this research project. Specifically, we would like to thank Valérie SULIS for her project follow-up and advice. We would also like to thank Francisco CHINESTA, a university professor and researcher at the Laboratory for Processes and Engineering in Mechanics and Materials (PIMM), for his contribution to this project through his expertise in the dimensional reduction and surrogate models. Finally, we would like to thank Sébastien BURGUN and Alexandre FENDLER for their technical support during the various tests conducted.

References

1. Mull, J.-F., Durand, C., Baudouin, C., Bigot, R.: A new tailored solution to predict blow efficiency and energy consumption of hammer-forging machines. *Int./J. Adv. Manufact. Technol.* **111**(7–8), 1941–1954 (2020). <https://doi.org/10.1007/s00170-020-06237-2>
2. Durand, C., Bigot, R., Baudouin, C.: Contribution to characterization of metal forming machines: application to screw presses. *Proc. Manuf.* **15**, 1024–1032 (2018). <https://doi.org/10.1016/j.promfg.2018.07.391>
3. Bigot, R., Leleu, S., Martin, P.: Forming machine qualification by analysis of manufactured parts geometry: application to aluminium forming process. *Int. J. Adv. Manuf. Technol.* **21**(7), 476–482 (2003). <https://doi.org/10.1007/s001700300056>
4. Vajpayee, S., Sadek, M.M.: Effects of structural and forming parameters on the efficiency of energy transfer in impact forming machines. *J. Eng. Ind.* **100**(2), 113–118 (1978). <https://doi.org/10.1115/1.3439397>
5. Vajpayee, S., Sadek, M.M., Tobias, S.A.: The efficiency and clash load of impact forming machines to the second order of approximation. *Int. J. Mach. Tool Des. Res.* **19**(4), 237–252 (1979). [https://doi.org/10.1016/0020-7357\(79\)90013-1](https://doi.org/10.1016/0020-7357(79)90013-1)
6. Harwood, M., Novak, M.: Uplift in hammer foundations. *Soil Dyn. Earthq. Eng.* **5**(2), 102–117 (1986). [https://doi.org/10.1016/0267-7261\(86\)90004-7](https://doi.org/10.1016/0267-7261(86)90004-7)
7. Swidergal, K., et al.: Experimental and numerical investigation of blankholder's vibration in a forming tool: a coupled MBS-FEM approach. *Prod. Eng. Res. Devel.* **9**(5–6), 623–634 (2015). <https://doi.org/10.1007/s11740-015-0640-9>
8. Novak, M.: Foundations for shock-producing machines. *Can. Geotech. J.* (1983). <https://www.semanticscholar.org/paper/Foundations-for-shock-producing-machines-Novak/f97002aecee038c94b7a122cba28b0add79c4f0> (Accessed 03 Mar 2023)
9. Zheng, E., Zhou, X.: Modeling and simulation of flexible slider-crank mechanism with clearance for a closed high speed press system. *Mech. Mach. Theory* **74**, 10–30 (2014). <https://doi.org/10.1016/j.mechmachtheory.2013.11.015>
10. Mull, J.-F., Durand, C., Baudouin, C., Bigot, R.: A fe billet model and a spring-mass-damper model for the simulation of dynamic forging process: application to a screw press. In: Daehn, G., Cao, J., Kinsey, B., Tekkaya, E., Vivek, A., Yoshida, Y. (eds.) *Forming the Future. TMMMS*, pp. 1131–1143. Springer, Cham (2021). https://doi.org/10.1007/978-3-030-75381-8_95

11. Brecher, C., Klein, W., Tannert, M.: Optimization of multi-stage closed-die forging processes by coupled simulation of the machine and the forging processes. *Prod. Eng.* **4**(2), 279–286 (2010). <https://doi.org/10.1007/s11740-010-0226-5>
12. P. Benner, S. Grivet-Tralocia, A. Quarteroni, G. Rozza, W. Schilders, and L. M. Silveira, Eds., *System- and Data-Driven Methods and Algorithms*, vol. 1. De Gruyter, 2021. doi: <https://doi.org/10.1515/9783110498967>
13. Hürkamp, A., et al.: Combining simulation and machine learning as digital twin for the manufacturing of overmolded thermoplastic composites. *J. Manuf. Mater. Process.* **4**(3), 92 (2020). <https://doi.org/10.3390/jmmp4030092>
14. Gustafsson, E.: Optimization of Castings by using Surrogate Models (2007). <http://urn.kb.se/resolve?urn=urn:nbn:se:liu:diva-10192> (Accessed 04 Jan. 2022)
15. Ryser, M., Bambach, M.: Comparison of Linear regression and neural networks as surrogates for sensor modeling on a deep drawn part. In: Daehn, G., Cao, J., Kinsey, B., Tekkaya, E., Vivek, A., Yoshida, Y. (eds.) *Forming the Future. TMMMS*, pp. 611–623. Springer, Cham (2021). https://doi.org/10.1007/978-3-030-75381-8_50
16. Cai, L., Ren, L., Wang, Y., Xie, W., Zhu, G., Gao, H.: Surrogate models based on machine learning methods for parameter estimation of left ventricular myocardium. *R. Soc. Open Sci.* **8**(1), 201121 (2021). <https://doi.org/10.1098/rsos.201121>
17. Giorleo, L., Ceretti, E., Giardini, C.: Energy consumption reduction in Ring Rolling processes: a FEM analysis. *Int. J. Mech. Sci.* **74**, 55–64 (2013). <https://doi.org/10.1016/j.ijmecsci.2013.04.008>
18. Uribe, D., Durand, C., Baudouin, C., Bigot, R.: Vers l’asservissement du pilotage en énergie d’une opération de forgeage : développement d’un métamodèle prédictif pour un jumeau numérique. Presented at the 25e Congrès Français de Mécanique (CFM 2022) (Aug. 2022). <https://hal.science/hal-03841517>
19. Altan, T., Ngaile, G., Shen, G. (eds.) *Cold and hot forging: fundamentals and applications*. Materials Park, OH: ASM International (2004)
20. Tschätsch, H.: *Metal forming practise: processes - machines - tools* (2006)
21. Marie, S., Ducloux, R., Lasne, P., Barlier, J., Fourment, L.: Inverse Analysis of Forming Processes Based on FORGE Environment (2014). <https://doi.org/10.4028/www.scientific.net/KEM.611-612.1494>
22. Emmerich, M., Giotis, A., Özdemir, M., Bäck, T., Giannakoglou, K.: Metamodel—assisted evolution strategies. In: Guervós, J.J.M., Adamidis, P., Beyer, H.-G., Schwefel, H.-P., Fernández-Villacañas, J.-L. (eds.) *PPSN 2002. LNCS*, vol. 2439, pp. 361–370. Springer, Heidelberg (2002). https://doi.org/10.1007/3-540-45712-7_35
23. Belur, B.K., Grandhi, R.V.: Geometric deviations in forging and cooling operations due to process uncertainties. *J. Mater. Process. Technol.* **152**(2), 204–214 (2004). <https://doi.org/10.1016/j.jmatprotec.2004.02.064>
24. Wiebenga, J.H., Atzema, E.H., van den Boogaard, A.H.: Stretching the limits of forming processes by robust optimization: a numerical and experimental demonstrator. *J. Mater. Process. Technol.* **217**, 345–355 (2015). <https://doi.org/10.1016/j.jmatprotec.2014.11.018>
25. Shang, H., Wu, P., Lou, Y.: Strain hardening of aa5182-o considering strain rate and temperature effect. In: Daehn, G., Cao, J., Kinsey, B., Tekkaya, E., Vivek, A., Yoshida, Y. (eds.) *Forming the Future. TMMMS*, pp. 657–665. Springer, Cham (2021). https://doi.org/10.1007/978-3-030-75381-8_54
26. Hedicke-Claus, Y., Kriwall, M., Langner, J., Stonis, M., Behrens, B.-A.: Validation of automatically generated forging sequences by using FE simulations. In: Daehn, G., Cao, J., Kinsey, B., Tekkaya, E., Vivek, A., Yoshida, Y. (eds.) *Forming the Future. TMMMS*, pp. 2867–2881. Springer, Cham (2021). https://doi.org/10.1007/978-3-030-75381-8_238

27. Li, S., Guo, Z., Cheng, S., Zhang, X.: Design optimization of sheet metal stamped parts by CAE simulation and back-propagation neural network. *Procedia Eng.* **81**, 1023–1028 (2014). <https://doi.org/10.1016/j.proeng.2014.10.135>
28. Rao, K.P., Prasad, Y.K.D.V.: Neural network approach to flow stress evaluation in hot deformation. *J. Mater. Process. Technol.* **53**(3–4), 552–566 (1995). [https://doi.org/10.1016/0924-0136\(94\)01744-L](https://doi.org/10.1016/0924-0136(94)01744-L)
29. Goodfellow, I., Bengio, Y., Courville, A.: *Deep learning*. The MIT Press, Cambridge, Massachusetts (2016)
30. Brownlee, J.: How to Choose Loss Functions When Training Deep Learning Neural Networks, *Machine Learning Mastery.com*, Jan. 29 (2019). <https://machinelearningmastery.com/how-to-choose-loss-functions-when-training-deep-learning-neural-networks/> (Accessed 23 Jan 2023)