



Science Arts & Métiers (SAM)

is an open access repository that collects the work of Arts et Métiers Institute of Technology researchers and makes it freely available over the web where possible.

This is an author-deposited version published in: <https://sam.ensam.eu>
Handle ID: <http://hdl.handle.net/10985/6394>

To cite this version :

Saïd ETTAQI, Laurent LANGLOIS - Cobalt-based superalloy layers deposited on X38CrMoV5 steel base metal by explosion cladding process - 2008

Any correspondence concerning this service should be sent to the repository

Administrator : scienceouverte@ensam.eu



Illustrations

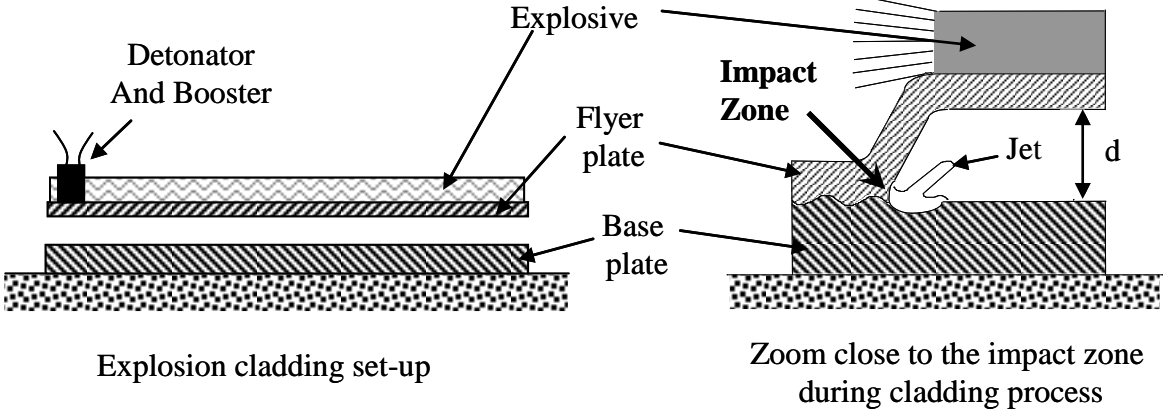

Figure 1

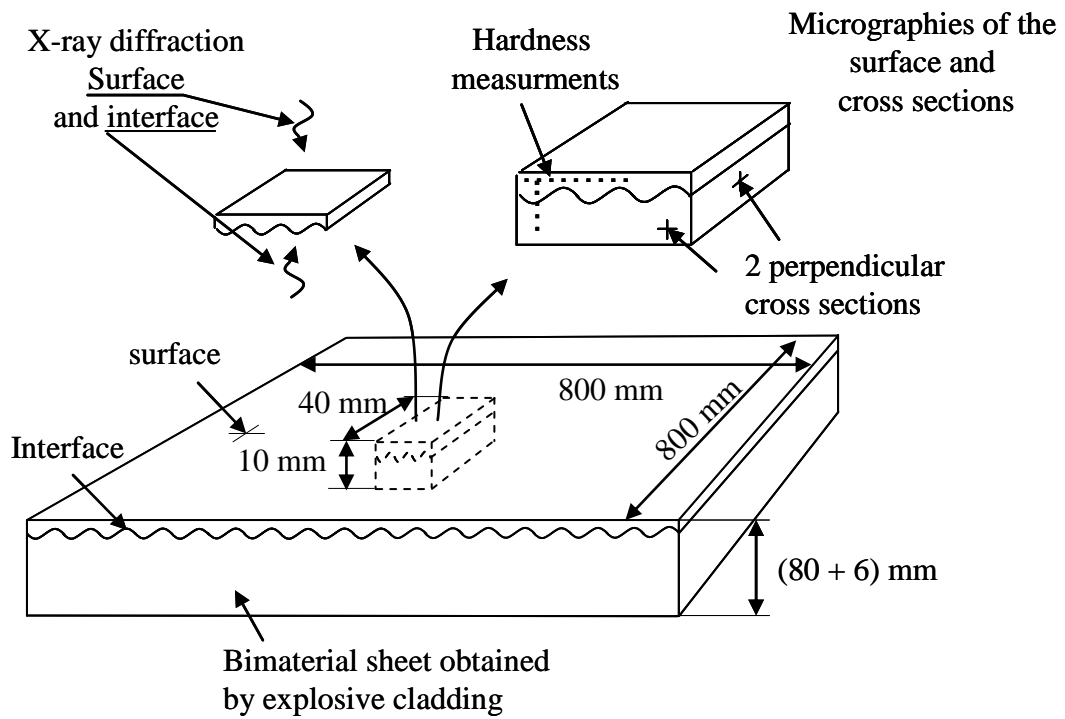

Figure 2

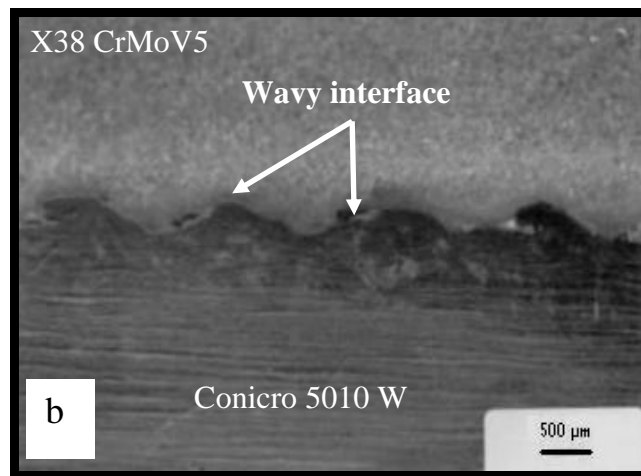
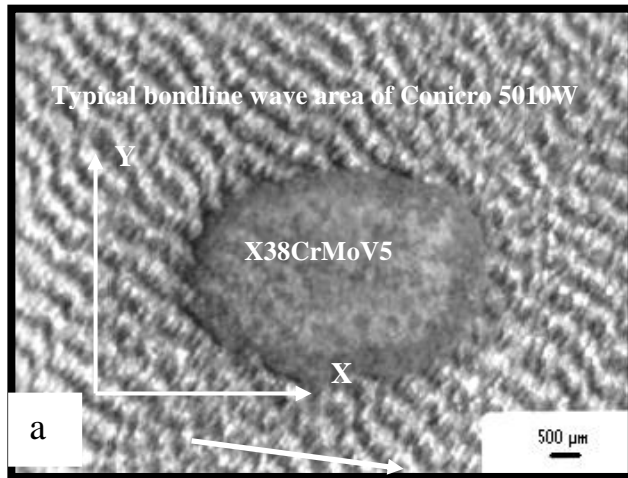

Figure 3

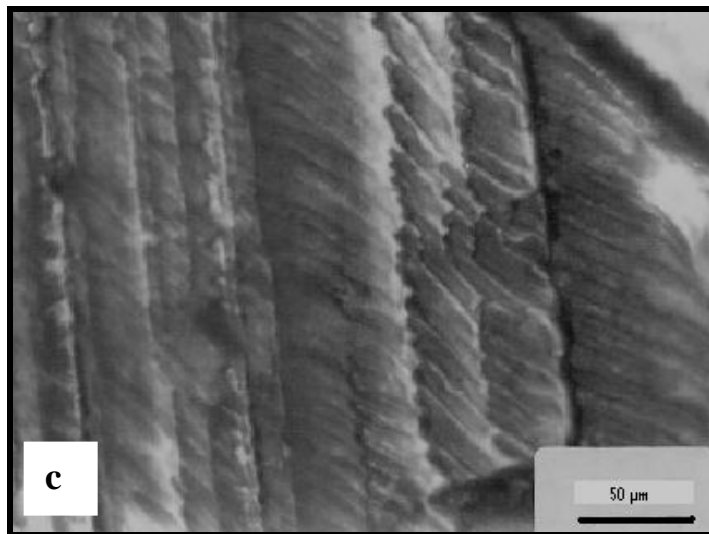
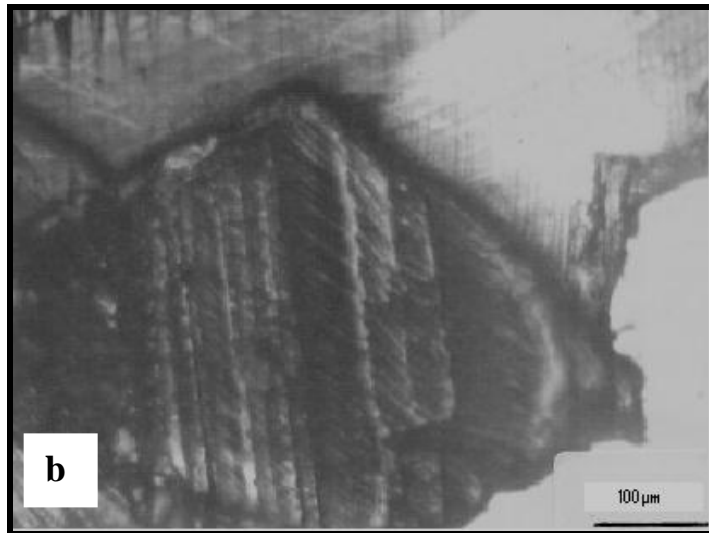
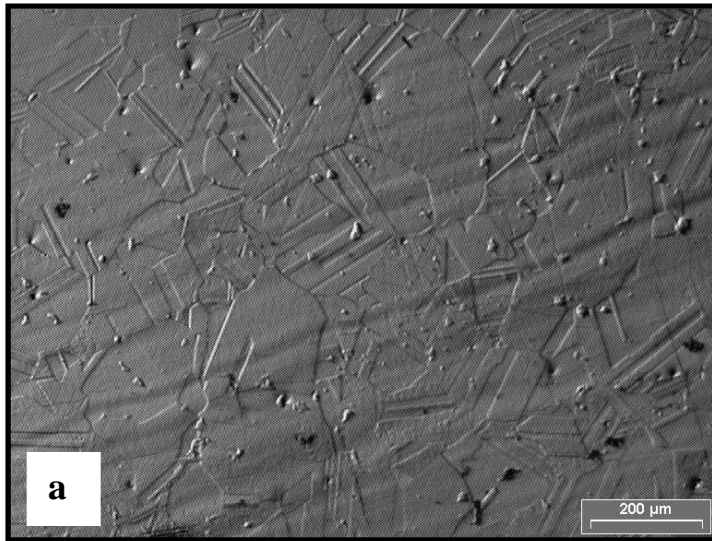

Figure 4

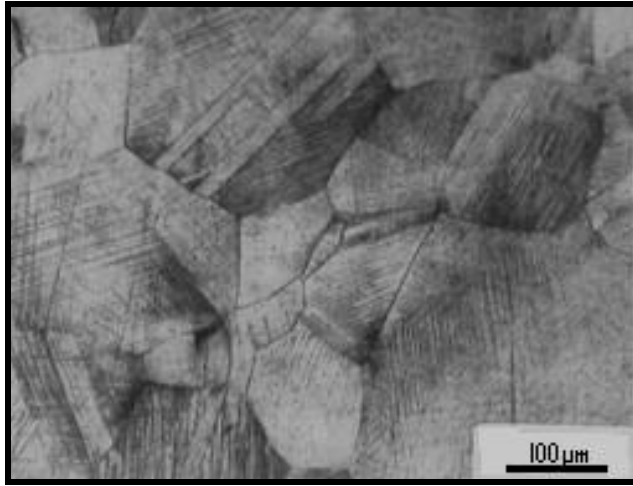

Figure 5

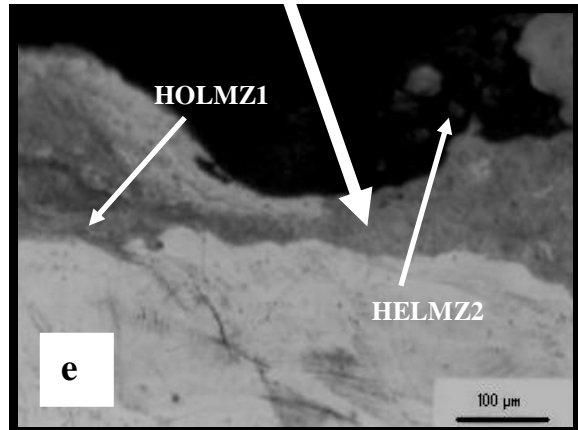
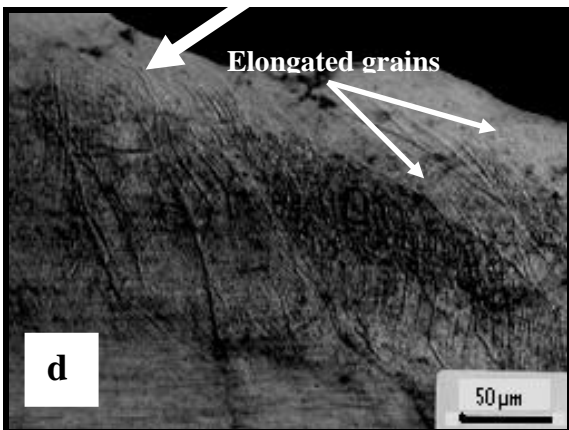
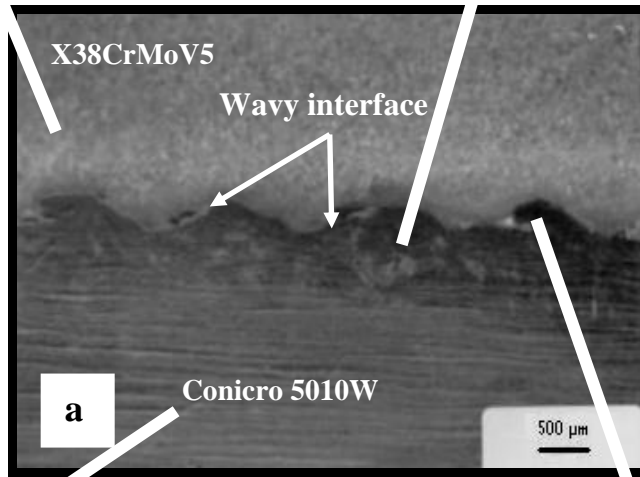
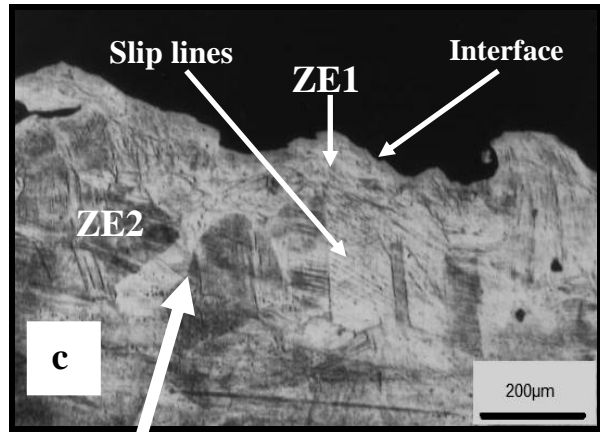
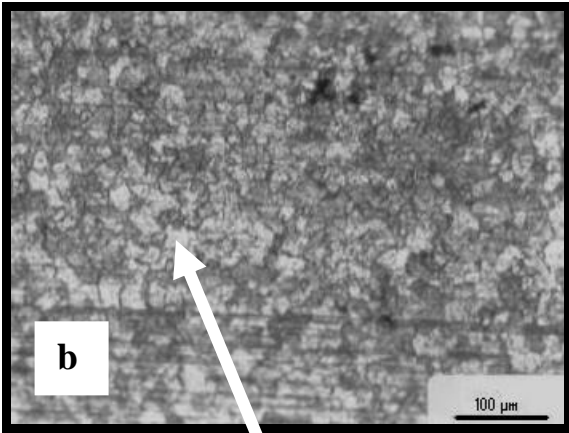

Figure 6

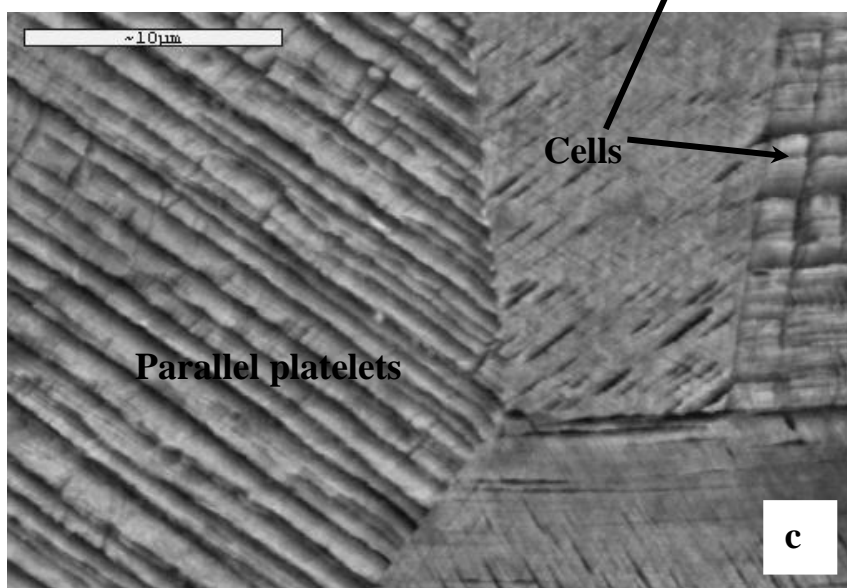
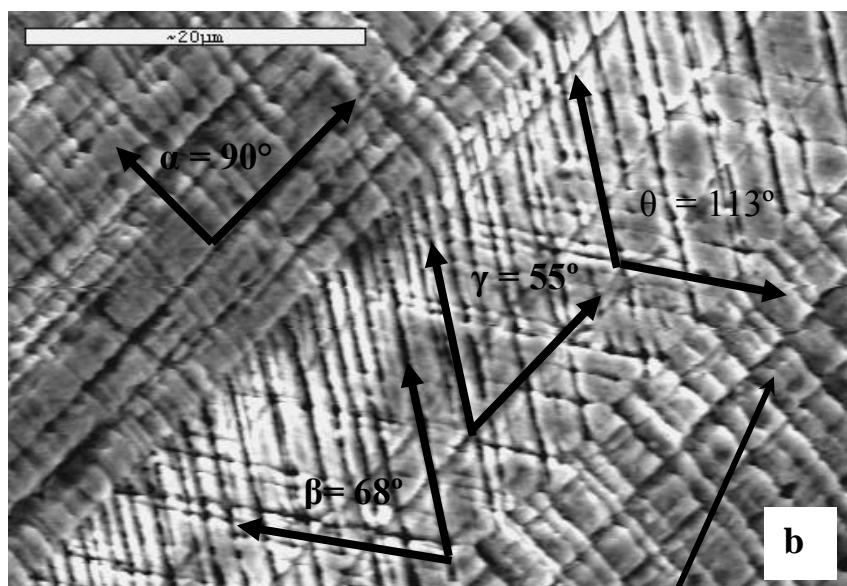
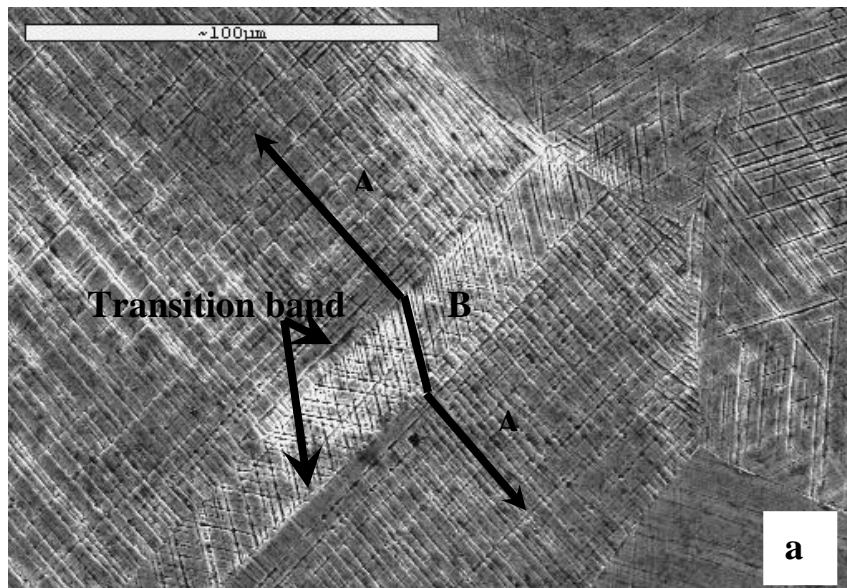

Figure 7

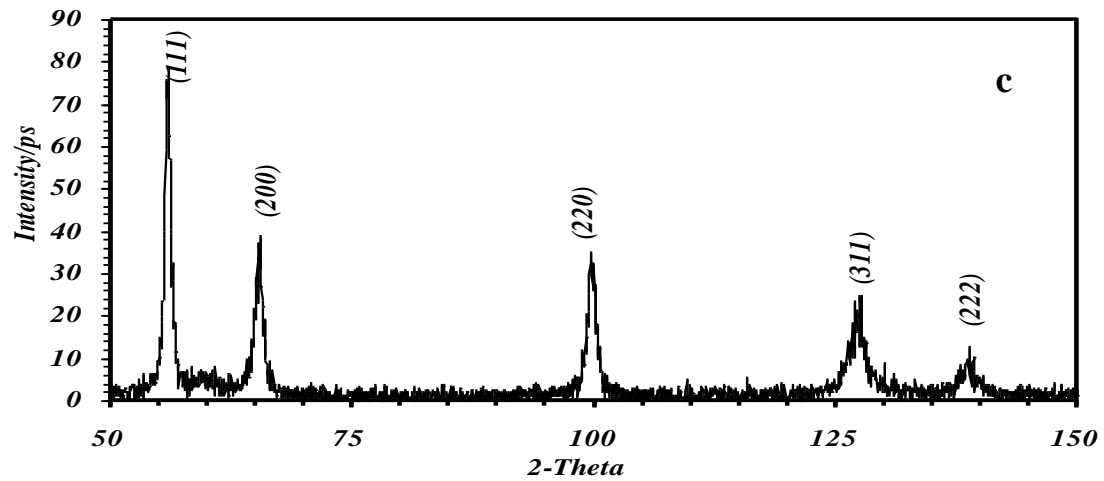
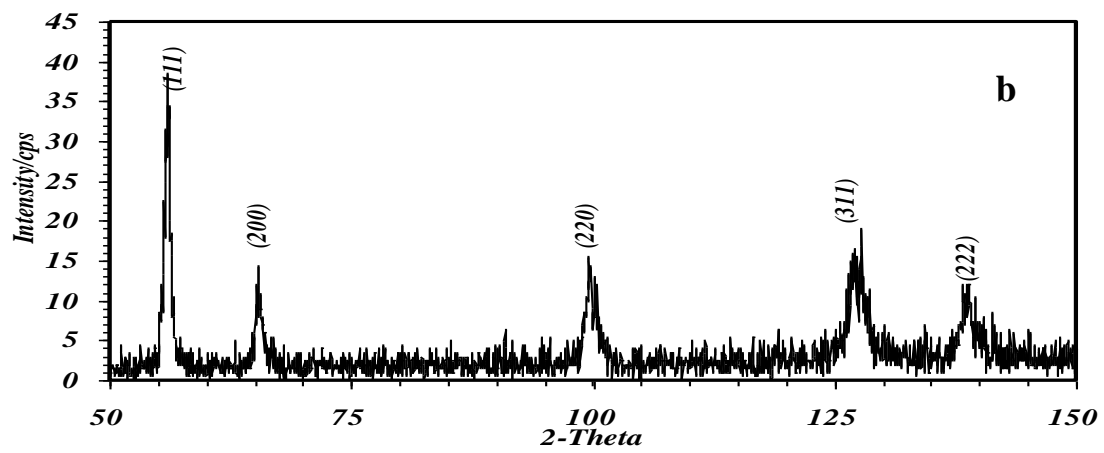
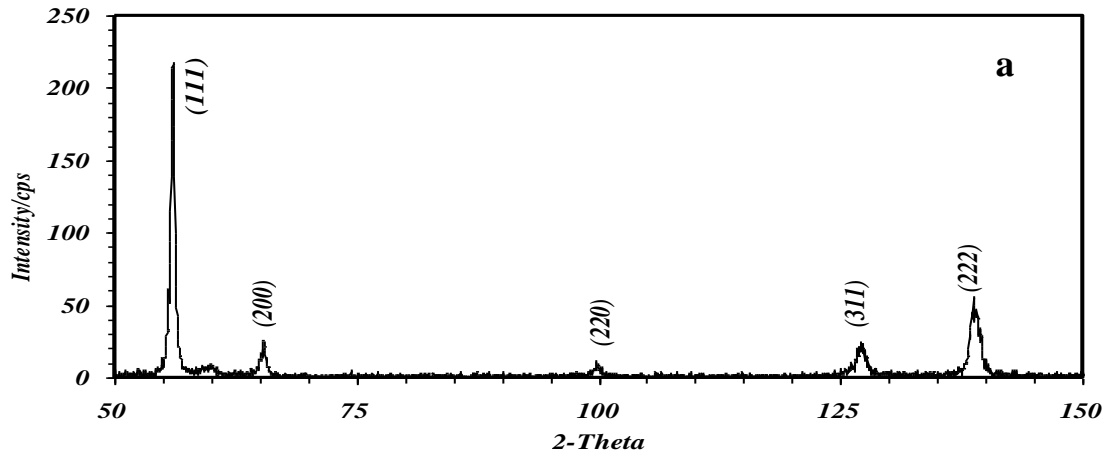

Figure 8

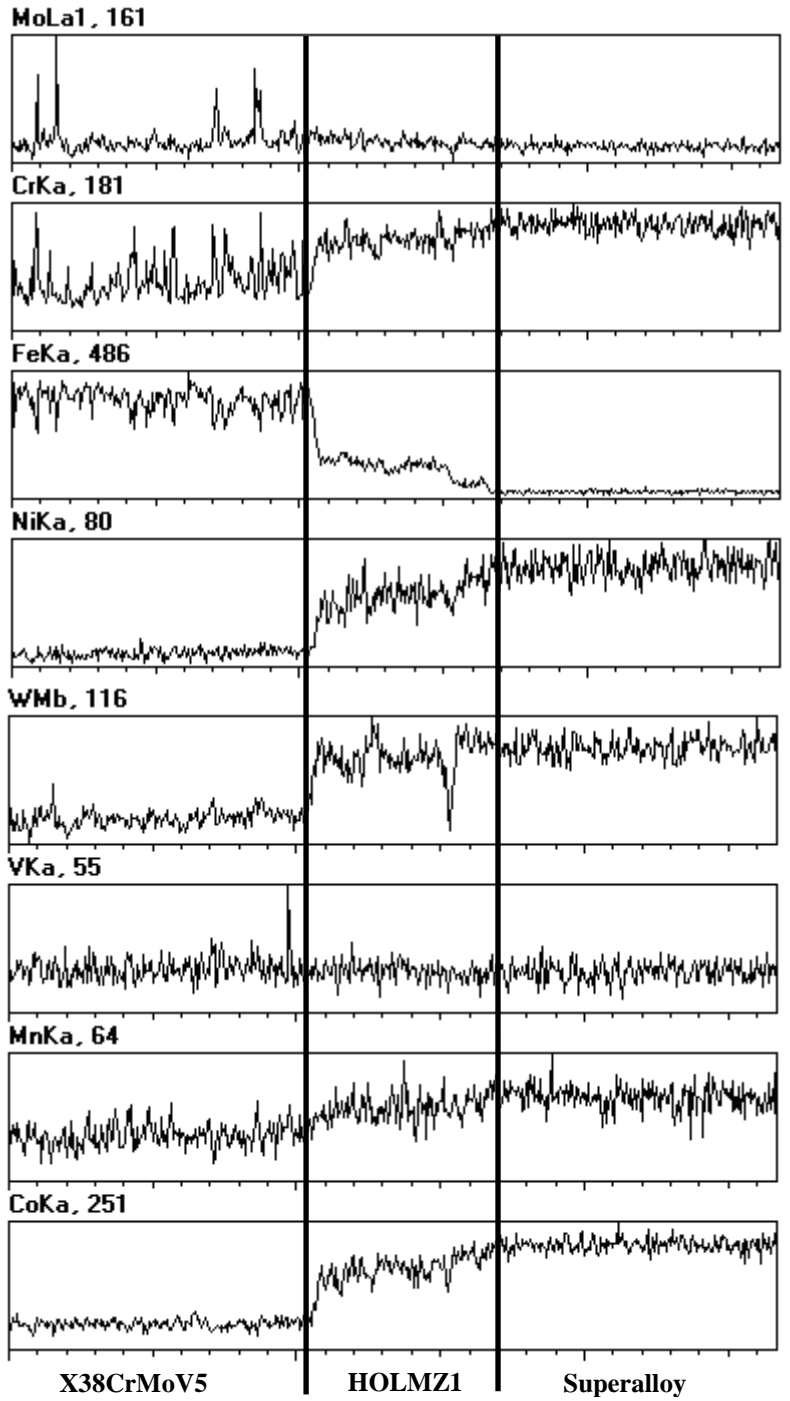
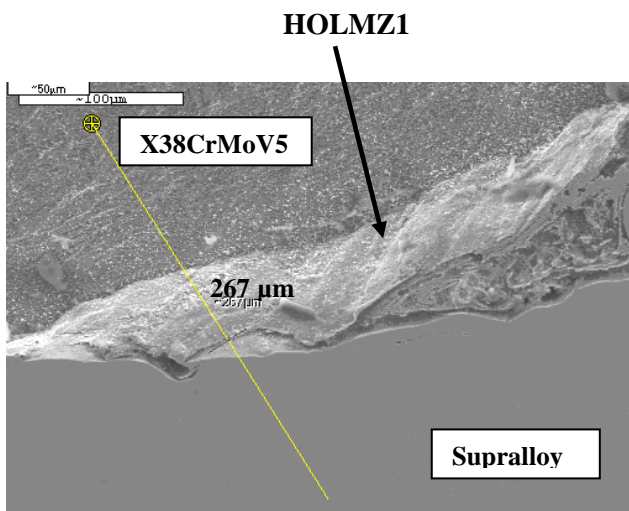

Figure 9

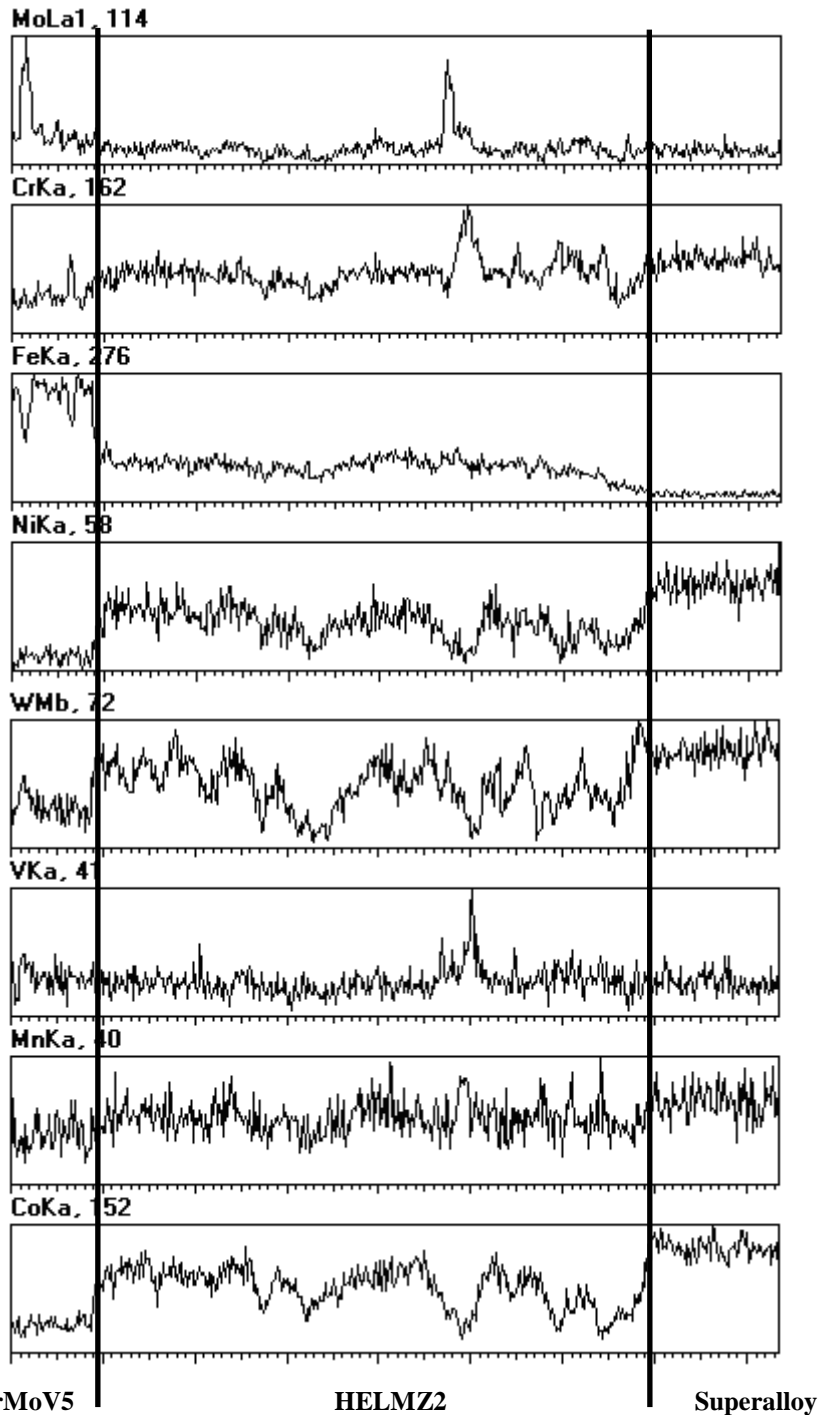
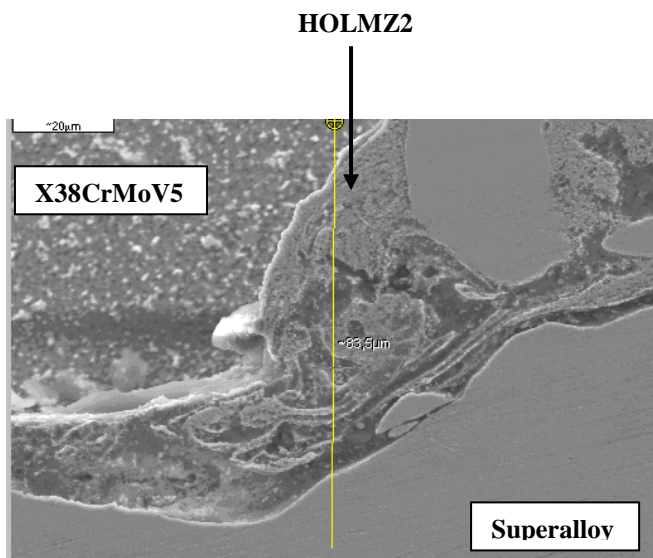

Figure 10

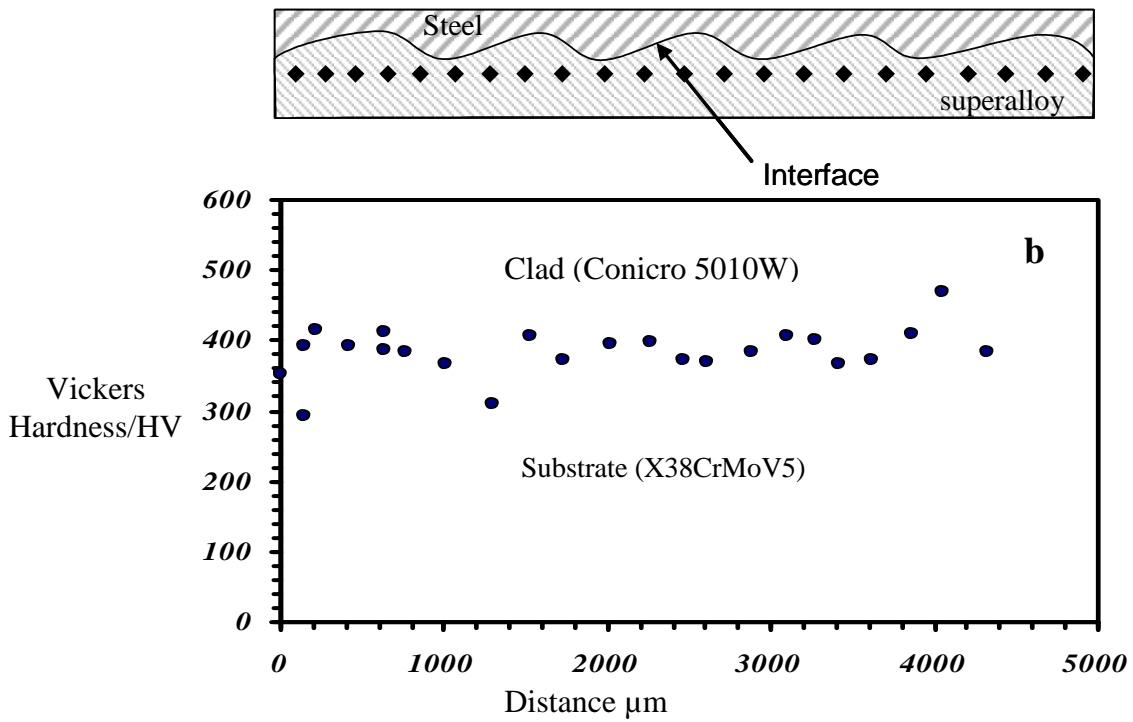
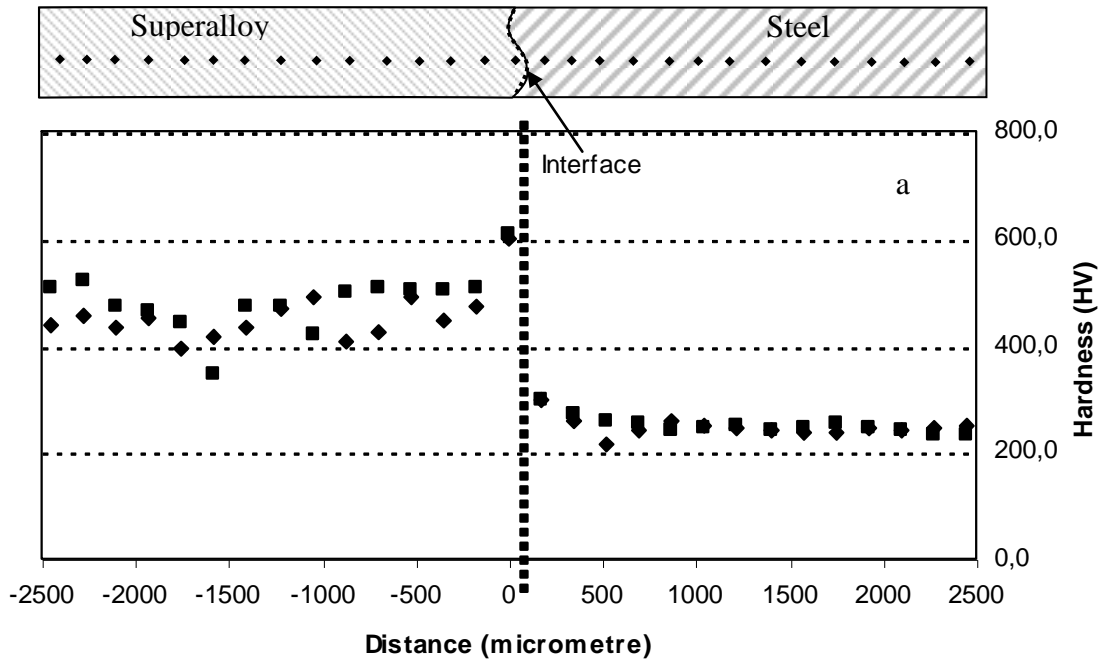

Figure 11

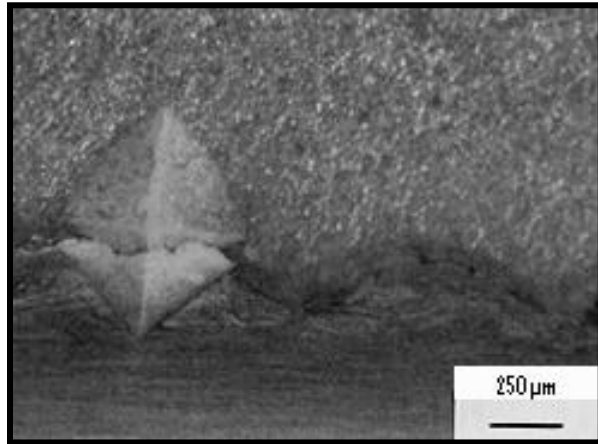

Figure 12