



### **Science Arts & Métiers (SAM)**

is an open access repository that collects the work of Arts et Métiers Institute of Technology researchers and makes it freely available over the web where possible.

This is an author-deposited version published in: <https://sam.ensam.eu>  
Handle ID: <http://hdl.handle.net/10985/8485>

#### **To cite this version :**

Yusram MASSIJAYA, Abigael KABE, Istie RAHAYU, Barbara OZARSKA, Louis DENAUD - Lathe Check Characteristics of Fast Growing Sengon Veneers and Their Effect on LVL Glue-Bond and Bending Strength - Journal of Materials Processing Technology p.8 - 2014

Any correspondence concerning this service should be sent to the repository

Administrator : [scienceouverte@ensam.eu](mailto:scienceouverte@ensam.eu)



## Accepted Manuscript

Title: Lathe Check Characteristics of Fast Growing Sengon Veneers and Their Effect on LVL Glue-Bond and Bending Strength

Author: Wayan Darmawan Dodi Nandika Yusram Massijaya  
Abigael Kabe Istie Rahayu Louis Denaud Barbara Ozarska



PII: S0924-0136(14)00315-X  
DOI: <http://dx.doi.org/doi:10.1016/j.jmatprotec.2014.08.015>  
Reference: PROTEC 14095

To appear in: *Journal of Materials Processing Technology*

Received date: 11-2-2014  
Revised date: 6-6-2014  
Accepted date: 16-8-2014

Please cite this article as: Darmawan, W., Nandika, D., Massijaya, Y., Kabe, A., Rahayu, I., Denaud, L., Ozarska, B., Lathe Check Characteristics of Fast Growing Sengon Veneers and Their Effect on LVL Glue-Bond and Bending Strength, *Journal of Materials Processing Technology* (2014), <http://dx.doi.org/10.1016/j.jmatprotec.2014.08.015>

This is a PDF file of an unedited manuscript that has been accepted for publication. As a service to our customers we are providing this early version of the manuscript. The manuscript will undergo copyediting, typesetting, and review of the resulting proof before it is published in its final form. Please note that during the production process errors may be discovered which could affect the content, and all legal disclaimers that apply to the journal pertain.

1 **Original Article**

2 This article was written based on the experimental results conducted at Bogor Agricultural Univ., and INRA,  
3 Nancy, France

4 This article has not been published elsewhere, and would like to be published at the Journal of Materials  
5 Processing Technology  
6

7 **Lathe Check Characteristics of Fast Growing Sengon Veneers and**  
8 **Their Effect on LVL Glue-Bond and Bending Strength**

9 Wayan Darmawan<sup>(1)\*</sup>, Dodi Nandika<sup>(1)</sup>, Yusram Massijaya<sup>(1)</sup>,  
10 Abigael Kabe<sup>(2)</sup>, Istie Rahayu<sup>(2)</sup>, Louis Denaud<sup>(3)</sup>, Barbara Ozarska<sup>(4)</sup>

11  
12 <sup>(1)</sup>*Prof., Department of Forest Products, Faculty of Forestry,*  
13 *Bogor Agricultural University (IPB), Bogor (16680), Indonesia.*  
14 Phone +62-251-8621285, Fax. +62-251-8621256

15 E-mail : wayandar@indo.net.id

16 \* (Corresponding author)

17 <sup>(2)</sup>*Research Assistant, Department of Forest Products, Faculty of Forestry,*  
18 *Bogor Agricultural University (IPB), Bogor (16680), Indonesia.*

19 <sup>(3)</sup>*Associate Professor, Art et Metier ParisTech, France*

20 <sup>(4)</sup>*Associate Professor, University of Melbourne, Australia*

21 **Abstract**

22 Fast growing sengon (*Paraserianthes moluccana*) is largely rotary-cut to produce veneer  
23 for core plywood production. In order to provide better information on veneer production  
24 and utilization, in this study the effects of wood juvenility and veneer thickness on lathe  
25 checks of rotary-cut sengon veneers were evaluated. Before veneer manufacturing, sengon  
26 logs were boiled at 50 °C and 75 °C for 4 and 8 hours respectively. The boiled logs were  
27 peeled to produce veneer of 1 mm, 1.5 mm, 2 mm in thickness. Lathe checks of veneers  
28 were measured on the loosed side at every 5 mm veneer length under an optical video  
29 microscope and their frequency, depth, and length were characterized. Twenty sampling  
30 points of 5 mm veneer length were prepared from each segmented ring of 1 cm width from  
31 pith to bark. Isocyanate resin adhesive were used to produce laminated veneer lumber  
32 (LVL) of 20 mm thick, which consisted of 24-ply of 1 mm veneer thick, 14-ply of 1.5 mm  
33 veneer thick, and 11-ply of 2 mm veneer thick, for glue bond and bending strength test.  
34 Results showed that wood juvenility and veneer thickness determined the frequency, depth  
35 and length of lathe checks for the sengon rotary-cut veneers. In general, the frequency of  
36 lathe checks of the veneer increases with increasing veneer thickness, and also increases  
37 from pith to bark. Boiling of logs before rotary-cutting could decrease the frequency of  
38 lathe check of the veneer. The results indicated that boiling of logs at 50 °C for 8 h and at  
39 75 °C at least 4 h before peeling the logs could minimize the frequency of lathe check in  
40 manufacturing rotary cut veneer thickness of 1 mm, 1.5 mm, and 2 mm from juvenile  
41 wood of fast growing sengon. The frequency of lathe check affect significantly the glue  
42 bond and bending strength, in which the glue bond, Modulus of Elasticity (MOE), and  
43 Modulus of Rupture (MOR) decrease as the frequency of lathe checks increases.

44 **Keyword : Lathe check, Rotary-Cut Veneer, Fast Growing Sengon, Boiling, Glue-bond,**  
45 **Bending Strength, Laminated veneer lumber**

46

## 1 **1. Introduction**

2 Sengon (*Paraserianthes moluccana*) is a fast growing wood species widely planted by  
3 community in Indonesia. The sengon tress in the age of 7 years can reach breast height  
4 diameter up to 38 cm. Though all part of the tress in the age of 7 years are juvenile  
5 (**Darmawan et al., 2013**), however they have been felled in that age because demand of  
6 the sengon woods for wood industry is high, and are important incomes for the  
7 communities (**Krisnawati et al., 2011**). Sengon is the most common species used for  
8 packaging and pulp in Indonesia. Recently the sengon wood has been rotary cut for  
9 laminated-wood products. Since the sengon wood is being used in the laminated wood  
10 industry, high bonding properties are expected. However, as the sengon logs are being  
11 peeled and much more juvenile woods are being utilized, severe lathe check veneer would  
12 undoubtedly be produced and manufactured. Therefore, it considerably needs to study  
13 lathe checks of veneer peeled from the sengon logs, and their effect on the glue bond and  
14 bending strength.

15

16 The bonding strength of the veneers depends upon a variety of factors. These factors are  
17 classified as veneers quality (moisture content, density, lathe checks, and surface  
18 roughness) and as adhesive quality (type of adhesive, mixture of adhesive, and its  
19 viscosity) and as bonding quality (glue spread, pressure time and temperature, relative  
20 humidity, and temperature of air) (**Dundar et al., 2008a**). Among these factors, lathe  
21 check is one of the important factors on the bonding strength. The bonding strength  
22 decreases, probably because of the presence of important lathe checks. Also, the veneers  
23 with lathe checks require much more glue spread because of the degradation of veneer  
24 surface topography (**Daoui et al., 2011**). Veneers with lathe checks can also cause  
25 excessive resin use and may result in resin-bleed through the inside of veneer.

1 In rotary-cut veneer manufacturing, when peeling starts, the wood tends to split along the  
2 grain. Lathe checks are formed at the veneer's loose side (**Fig. 1**) as tension force of the  
3 lathe's knife pulls the veneer away from the peeler block and flattens the veneer from its  
4 natural curvature (**DeVallance et al., 2007**). With respect to the cross section of the  
5 veneer, this advance splitting causes the formation of vertical cracks (known as lathe  
6 checks). The depth, length and frequency of lathe checks have been widely taken into  
7 account during veneer surface quality evaluation. The risk of this checking can be reduced  
8 by using a nosebar (**Kollmann et al. 1975**). However, recent spindle less rotary lathes,  
9 which are widely used to peel small log diameter of fast growing wood species, have not  
10 been completed with an adjustable nosebar. A boiling treatment of bolts would be  
11 considered to reduce the lathe check.

12

13 There are many factors which contribute to the formation and severity of veneer lathe  
14 checks. It is usually very difficult to determine the exact cause of checking for any given  
15 incident. However, experience and research have taught us some of the most common and  
16 severe influences of veneer lathe checking. Veneer lathe check can be affected by wood  
17 log's characteristic (specific gravity, wood pores, juvenile and mature wood). In addition,  
18 pretreatment and manufacturing conditions such as steaming or boiling, knife bevel and  
19 nose bar pressure, peeling temperature, peeling thickness and peeling speed, may also  
20 affect lathe checks.

21

22 The pretreatment and manufacturing factors affecting lathe check can be controlled to  
23 achieve better veneer surface. Log temperature at the time of peeling veneer significantly  
24 affects the quality of veneer. Low temperatures produce veneers with deeper and more  
25 spaced checks than high temperatures log (**Suh and Kim, 1988; Duplex et al., 2012**).

3

1 Other studies indicated that higher peeling temperatures reduced the severity of lathe check  
2 depth (**Palka, 1974**). Most wood species are said to produce the best veneer quality when  
3 log temperatures are between 100 °F to 160 °F. **Dundar et al. (2008b)** found that when  
4 beech logs boiled in water at 60–70 °C for 20 h, 40 h, and 60 h, the veneers obtained from a  
5 40 h boiling period could minimize the mean surface roughness values for all veneers  
6 obtained from inner (heartwood), center or outer (sapwood) portion of the logs. The  
7 magnitude of compression applied to veneer surface was considered as important factor  
8 that affects peeled veneer quality. Pressure can be applied ahead of the knife by use of nose  
9 bar pressure. In eucalyptus veneer, the lathe check was found to decrease when the veneer  
10 was peeled with nose bar pressure up to 5% (ratio of lead gap opening to thickness).  
11 Between 0.5 to 5% pressures, deformation is within the elastic zone of the eucalyptus  
12 (**Acevedo et al., 2012**). Another study indicated that settings the nose bar pressure up to a  
13 certain point by adjusting the lead and exit gap lathe (5% to 20%) reduced lathe check  
14 depth in redwood veneer (**Cumming and Collett, 1970**) and also showed a tendency to  
15 produce more frequent shallow lathe checks. In many instances, higher horizontal  
16 pressures are needed for thicker veneers and lower pressure for thinner veneers, and in  
17 general, the thinner the veneer, the better the resulting peeled veneer quality. Rotary  
18 cutting speed (meter of veneer produced per minute) is another variable that affects veneer  
19 lathe check. An increase in cutting speed results in weaker veneer with deeper lathe checks  
20 (**Lutz, 1974**). An increase in speed causes reductions in nose bar pressure and can result in  
21 more severe lathe check formation.

22

23 Differences in log's wood properties have shown significant relationships to lathe check  
24 formation when peeled into veneer. In particular, tree growth rate, specific gravity,  
25 juvenility (the pith-to-bark variation in wood traits such as density, fiber length, microfibril

4

1 angle, longitudinal shrinkage, ring width, latewood proportion, and lignin-cellulose  
2 composition), and log conditioning have shown to affect veneer quality. A spindle-less  
3 rotary lathe allows manufacturers to peel smaller log's diameter and to produce more  
4 veneer sheet up to the log's core. When fast-grown logs were peeled, deeper lathe checking  
5 resulted. In general, it has been found that peeled quality is reduced as peeling from the  
6 log's sapwood to core material, due to factors such as lower specific gravity, highest  
7 growth rate, cutting speed, and highest angle of attack at the core material (**Palka and**  
8 **Holmes, 1973**). It has been noted that the best veneer was produced when peeling logs  
9 with growth rings orientated at  $0^\circ$  to the knife, while veneer quality decreased  
10 progressively as growth ring angle varied in either the plus or minus directions (**Cumming**  
11 **and Collett 1970**). Past research indicated that coarse grain, higher specific gravity veneer  
12 tends to check more significantly than does fine grain, lower specific gravity veneer. Lathe  
13 check depth was significantly less for fast growing trees (**Cumming et al. 1969**). Species  
14 of wood with fine pores check less than wood with large pores. This is because deep lathe  
15 checks and large pores create weak spots on the face veneer which provide less resistance  
16 to failure when the face veneer is under stress.

17

18 The effect of lathe checks on glue-bond quality, modulus of elasticity (MOE) and modulus  
19 of rupture (MOR) during laminated veneer lumber (LVL) production should be also  
20 important by considering that the increasing of lathe check on the veneer would lead to  
21 lower glue-bond quality and bending strength (MOE and MOR). Veneer with more  
22 frequent lathe checks may result in a higher incidence of delamination. To avoid  
23 delamination, the LVL may be typically produced by increasing the adhesive spread rate.  
24 Although increasing the adhesive spread rate is a common practice, however a question on  
25 how lathe checks affect the LVL glue-bond and bending strength would exist.

5

1 Investigation of lathe check characteristics of veneer from fast growing sengon and its  
2 LVL glue-bond and bending strength, gets less concern. Therefore it requires such study.  
3 The objectives of this study were 1) to evaluate the effects of wood juvenility, boiling  
4 temperature and veneer thickness on lathe checks of the rotary-cut sengon veneer  
5 (*Paraserianthes moluccana*); and 2) to determine the impact of veneer lathe checks on the  
6 LVL glue-bond and bending strength.

7

## 8 **2. Material and method**

9

### 10 **2.1 Sample tree origin**

11 Sample trees were obtained from a plantation forest planted by community at the West  
12 Java, Indonesia. The plantation site was located at Bogor region. Six sengon trees  
13 (*Paraserianthes moluccana*) were selected from the plantation site as representative  
14 specimens. The sample trees having straight stems and free external defects were chosen  
15 with the intent of minimizing tree-to-tree variation. The selected sample trees were 5 years  
16 old. The sample trees had a height of branch-free stem range from 6 to 8 m, and a  
17 diameter at breast height level (1.3 m above ground level) vary between 26 to 28 cm.  
18 After felling the trees, log sections (bolts) in length of 50 cm were taken from each tree  
19 from the bottom part up to the end of the free-branches tree stem. The sample logs were  
20 wrapped in plastic, kept cold, and maintained in the green condition before they were  
21 transported to the wood workshop for the rotary-cutting.

22

### 23 **2.2 Logs preparation for rotary-cutting**

24

25 Tree rings have been used for a long time in areas outside the tropics to characterize the  
26 presence of juvenile and mature wood. Considering distinct growth rings are absence in  
27 sengon tree, segmented ring was considered to be practically useful for characterizing their



1 juvenility. A specified 1 cm width of segmented rings was made from pith to bark on the  
 2 cross section of logs and numbered consecutively (No. 1-7) as shown in **Fig. 1**. Veneer  
 3 characteristics (veneer thickness, and veneer lathe checks) were measured at each  
 4 segmented ring, and used to characterize the quality of sengon veneers.

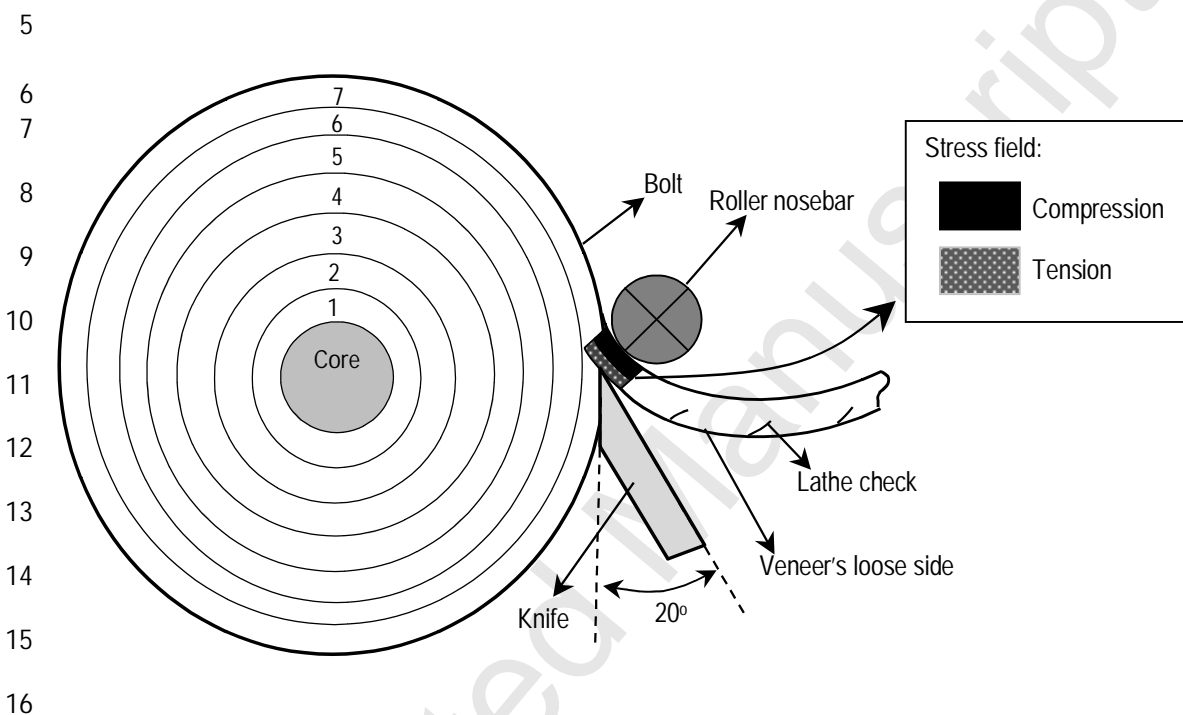

17 **Fig. 1**-Peeling diagram on the cross section of logs to produce veneers from segmented  
 18 rings number 1 to 7, and stress (tension and compression) occurring during the peeling

19

20 Thirty bolts of minimum 26 cm in diameter were selected, thus the first six bolts were  
 21 soaked in water at room temperature, and the other bolts were subjected to boiling process  
 22 in hot water at 50 and 75 °C for 4 and 8 h, respectively. Subsequently, the bolts in each  
 23 boiling treatment were peeled off to obtain veneers in the thickness of 1.0, 1.5, and 2.0  
 24 mm. For each boiling treatment, a sharp knife was used. The other factors such as knife  
 25 angle, peeling angle, nose bar pressure, log temperature, peeling speed were kept constant  
 26 in the study. The clearance angle was 0°, and knife angle was 20°. The veneers were peeled  
 27 using a spindle less rotary lathe. The bolts were peeled up to core diameter of 10 cm in

7

1 order to produce veneers from the 7 different segmented rings (**Fig. 1**). The veneers were  
2 collected and grouped for each segmented rings and numbered consecutively from near the  
3 pith (number 1) to near the bark (number 7). Veneer in each segmented rings was  
4 measured for characterizing the lathe checks (frequency, depth, and length), thickness  
5 variations, glue-bond, and bending strength.

6

### 7 **2.3 Measurements**

8 Veneer sheets produced from each segmented rings were collected and clipped to 30 cm x  
9 50 cm veneer specimens. Ten specimens from each segmented rings were randomly  
10 selected and kept in plastic bags for test specimens. Two test specimens were used for the  
11 measurement of thickness variations. Six points of thickness measurement were marked  
12 on the side of each test specimens.

13

#### 14 ***Lathe check frequency, depth, and length***

15 The test specimens were kept in the green condition. Subsequently, an optical scanning  
16 system was used to evaluate lathe check characteristics of the veneers. In this study, an  
17 optical video microscope was used to capture images from the surface of veneer's loose  
18 side. Before capturing, veneer samples of 1.0, 1.5, and 2.0 mm in thickness were arched  
19 on their loose side over a pulley in diameter of 20, 35, and 50 mm respectively. An  
20 illustration for the veneer thickness of 1.5 mm arched on the 35 mm pulley is presented in  
21 **Fig. 2a**, which depict the presence of lathe checks. Concerning the nature of veneer which  
22 is very fragile, then the success of measurement is strongly influenced by the choice of  
23 pulley diameter. **Palubicki (2010)** investigated that when diameter of the pulley is too  
24 small, the measurement process would lead to cracking and increased the depth of fissure  
25 thus the measure was not reliable. Otherwise, if diameter of pulley is too large, veneer  
26 cracks would not be opened so it was difficult to be detected by the camera. **Palubicki**

8

(2010) recommended to use the pulley diameter between 10 to 70 mm for veneer thickness between 0.5 to 3.5 mm. The loose side of the arched veneers was set up on the table of optical video microscope under 30x magnification. Length of captured images on the loose side of the arched veneer was recorded to be 5 mm each. For each segmented rings, 20 images were captured and stored in a disk. The images then were analyzed using motic image software to count the lathe checks frequency, then measure their depth ( $D_c$ ) and length ( $L_c$ ) (Fig. 2b). The measurement technique was based on the opening of cracks occurring on the loose side of arched veneers. Frequency of lathe check was presented as the number of lathe check per 10 cm length of veneer.

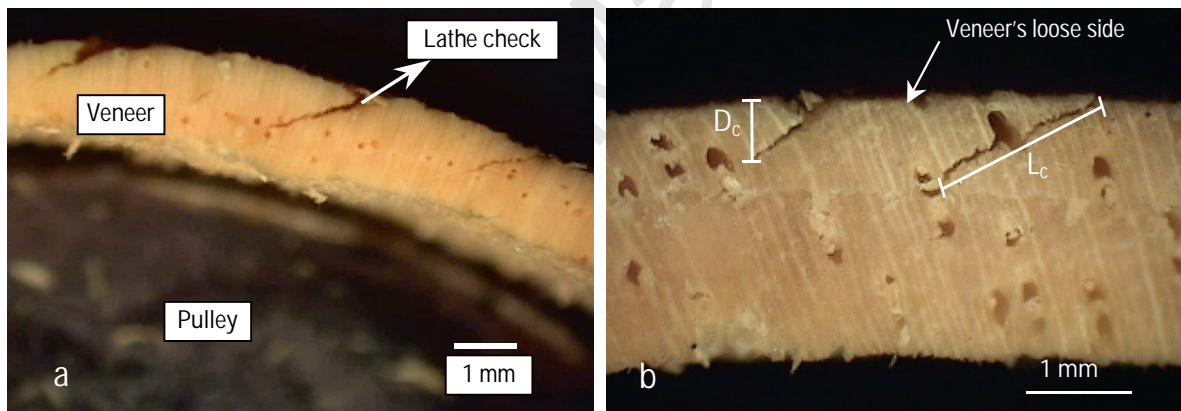

**Fig. 2** – Arched veneer presenting the lathe checks (a), and diagram for the lathe checks measurement (b)

### ***Glue-bond and bending strength test***

The veneer specimens were conditioned at relative humidity (RH) of 85% and temperature of 25 °C to an air-dry moisture content of 12%. Water based polymer Isocyanate resin adhesive was used for producing 20 mm thick of LVL panels. The isocyanate resin had a viscosity of 5000 - 15000 cps at 23°C, pH 6.5 – 8.5, solid material 40 - 44% and a density of 1.23 g/cm<sup>3</sup>. LVL panels with dimension of 20 mm x 30 mm x 500 mm were

1 manufactured by 1 mm veneer thick (24-ply), 1.5 mm veneer thick (14-ply), and 2 mm  
2 veneer thick (11-ply) at each segmented rings. The spread volume of the isocyanate resin  
3 was 200 g/m<sup>2</sup> on single bonding surface of the veneers as recommended by the  
4 manufacture. The glue was uniformly spread on the surface of veneers by hand brushing.  
5 Assembled samples were pressed in a cold press at a pressure of 10 kg/cm<sup>2</sup> for 5 hours.  
6 The resulting LVL panels were allowed to a stable condition for 72 h before cutting into  
7 test specimens.

8  
9 Tests for the glue bond and bending strength properties were conducted on test specimens  
10 prepared from the LVL panels. Prior to the testing, the specimens were conditioned for 2  
11 weeks at 25 °C and 85% relative humidity (RH) to air dry moisture content (around 12%).  
12 The air-dry glue bond and bending strength were tested. Five specimens were tested for  
13 each treatment combination. The glue bond and bending tests were carried out on an  
14 INSTRON universal testing machine. The shear strength of the glue bond was tested and  
15 measured with the lathe checks being pulled closed, as tested by **Rohumaa et al. (2013)**.  
16 Perpendicular to the fiber and glue line (flatwise) modulus of rupture (MOR) and modulus  
17 of elasticity (MOE) tests were carried out according to JAS standard (**JAS SE 11, 2003**).  
18 Specimen size for the bending tests was 300 mm long by 20 mm wide by 20 mm thick of  
19 LVL. Glue-bond tests were also carried out according to JAS SE 11. The dimension of  
20 test samples was 50 mm length by 20 mm width by 20 mm thick. A loading rate of 10  
21 mm/min was used in all tests according to the JAS SE 11. Loading on the glue bond test  
22 was continued until separation between the surfaces of the specimens occurred.

23  
24  
25

### 1 **3. Results and discussion**

#### 2 **3.1 Characteristics of sengon tree**

3 The breast height diameters for the sample sengon trees varied from 26 to 28 cm at the age  
4 of 5 years. The branches-free height of the sample sengon trees was between 6 to 8 m.  
5 Differences in diameter and in braches-free height among tress in this study reflect the  
6 sengon wood's sensitivity to environmental conditions. Sengon tree has been growing very  
7 fast and can flourish in tropical forests with an altitude of 0 to 1000 m above sea level. The breast  
8 height diameters indicate that the mean diameter growth for the sengon tree species would  
9 be about 5 to 6 cm/year. Investigation results for the sengon trees on the forest stand indicated  
10 that sengon tree stem has unique characteristics that are straight-trunked cylindrical and long  
11 braches-free height, which are very well used to manufacture veneers for plywood or LVL.  
12 In addition, density of sengon wood was reported to be 250 kg/m<sup>3</sup> close to the pith, and to  
13 be 450 kg/m<sup>3</sup> near the bark (**Darmawan et al., 2013**). This low density would bring a  
14 benefit in peeling the sengon trees for veneer production.

15

#### 16 **3.2 Characteristics of sengon veneer**

##### 17 *Variation of veneer thickness*

18 Uniformity of veneer thickness is a very important factor affecting the quality of glue bond  
19 strength in LVL or plywood. The result in **Fig. 3** shows that thickness variations of rotary-  
20 cut sengon veneers were slightly occurred. The thickness of sengon veneer peeled from  
21 some bolts, which was intended to be 1.0 mm, ranged from a minimum of 0.93 mm to a  
22 maximum of 1.08 mm, and the veneer thickness intended to be 2.0 mm ranged from a  
23 minimum of 1.95 mm to a maximum of 2.11 mm. Coefficient of variations of the veneer  
24 thickness from pith to bark calculated from the ranges was 5.3%, 5.8%, 5.9% for the  
25 intended veneer thickness of 1.0, 1.5, and 2.0 mm respectively. By considering the

1 coefficient of variations less than 6%, the bolts of sengon were correctly peeled to maintain  
2 the thickness regularity.

3

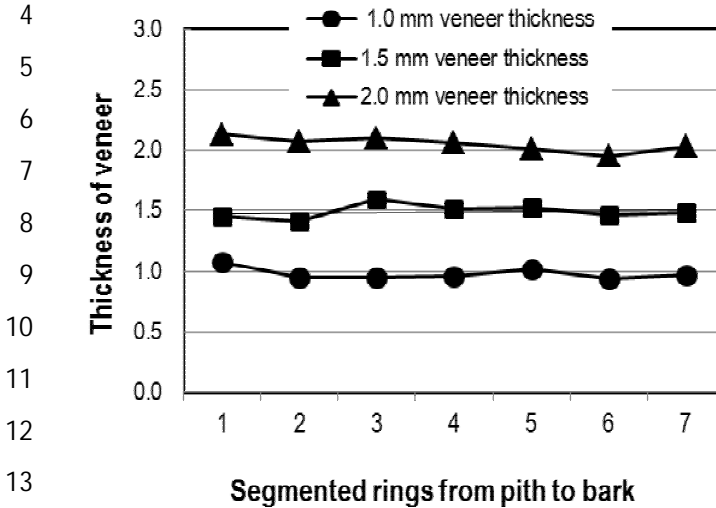

15 **Fig. 3** - Variation of veneer thickness from pith to bark

16

17 ***Lathe check frequency, depth, and length***

18 **Fig. 4** shows average values of frequency of lathe check per 10 cm of veneer length taken  
19 from the loose side of the veneer. The average frequency of lathe check tended to decrease  
20 from pith to bark of the veneers. The veneers near to the piths showed larger frequency of  
21 lathe check. Higher lignin content of the wood near the pith could be responsible for high  
22 frequency of lathe check of the veneers taken from the inner parts of the sengon logs. **Bao**  
23 **et. al. (2001)** noted that juvenile wood is an important wood quality attribute because it can  
24 have lower density, larger fibril angle, and high (more than 10%) lignin content and  
25 slightly lower cellulose content than mature wood. Higher frequency of lathe check near  
26 the pith could be also caused by smaller radius of its natural curvature in the bolt, which  
27 imposed greater tension during the flattening. Further **Tanritanir et al. (2006)**  
28 investigated the effect of steaming time on surface roughness of beech veneer and they also

1 found that the roughness of veneer sheets taken from heartwood (near pith) had higher  
2 values than those of sapwood (near bark).

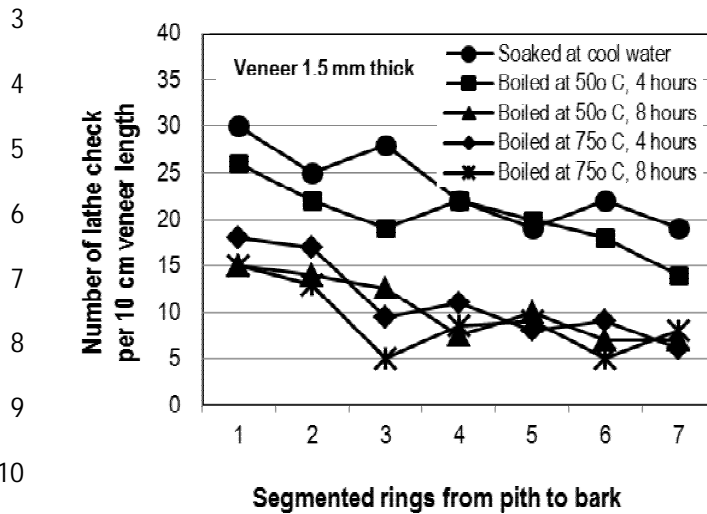

12 **Fig. 4 -** Variation of lathe check frequency from pith to bark for the 1.5 mm veneer  
13 thickness

14

15 The results in **Fig. 4** also reveal that veneers with lower frequency of lathe checks were  
16 produced by bolts boiled for 4h and 8h at temperature of 75 °C, and for 8h at temperature  
17 of 50 °C, when compare to unboiled bolts. However, the bolts boiled for 4h at 50 °C  
18 produced the same frequency of lathe checks as the unboiled bolts. This result gives an  
19 indication that boiling at a higher temperature resulted in better surface properties of the  
20 veneers. It could be announced that sengon bolts boiled for 8h at 50 °C or 4h at 75 °C  
21 could be proposed before manufacturing veneers from the sengon wood. The boiling of  
22 sengon bolts at the temperatures and periods is considered to soften the sengon bolts during  
23 the peeling process. A softening process does temporarily alter the microstructure of the  
24 wood, making it more plastic due to thermal expansion of crystal lattice of cellulose, and  
25 softening of lignin in the cell wall (**Jorgensen, 1968**). The softening by heat has produced  
26 a degree of plasticity roughly 10 times than that of wood at normal temperature, and

1 subsequently rendering the wood more pliable. The temperatures applied in this work  
 2 caused the sengon wood polymers to soften, and therefore the flattening of the veneer from  
 3 its natural curvature is more easily accommodated with less formation of lathe checks.

4  
 5 **Fig. 5** shows the values of lathe check from pith to bark for different veneer thickness.  
 6 Lathe check frequency of the veneers decreased from pith to bark. The lathe check  
 7 frequency of veneers near the pith was twice larger than near the bark. The results in **Fig.**  
 8 **5** indicated that the lathe check frequency tended to increase as the veneer thickness  
 9 increased. It can be considered that lathe checks on the loose side of veneer were generated  
 10 due to tensile stress in bending at the rake face of the knife (**Fig. 1**). Then, further  
 11 unbending process for flattening the veneer from its natural curvature caused the increase  
 12 of lathe checks. Surface tension generated by the unbending process would increase with  
 13 veneer thickness, and so it would cause small fracture (lathe check) more frequently. With  
 14 respect to the cross section of the veneer, the greater surface tension caused the formation  
 15 of more severe lathe checks.

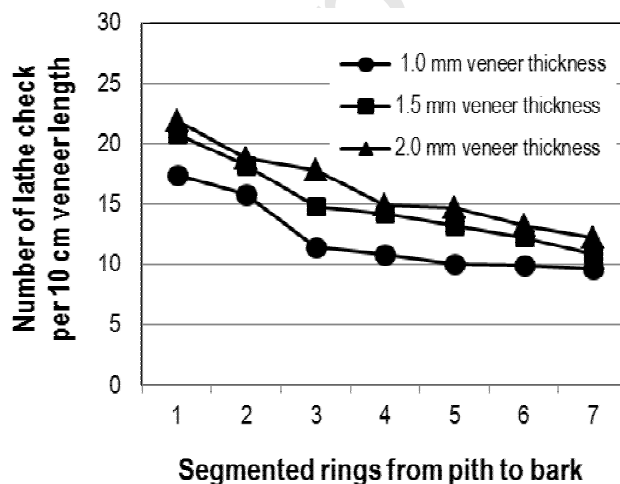

16  
 17  
 18  
 19  
 20  
 21  
 22  
 23  
 24  
 25 **Fig. 5** - The effect of veneer thickness on the frequency of lathe checks

26



1 The second variable that is important in determining the veneer quality is deep lathe checks  
 2 or shallow lathe checks. This study found that though the frequency of lathe checks  
 3 decrease from pith to bark (**Fig. 5**), however the depths of lathe check in percent of veneer  
 4 thickness are not significantly change from pith to bark (**Fig. 6b**), and did not differ  
 5 prominently among the veneer thick. This result indicates that the thicker the veneer  
 6 peeled, the deeper the lathe check will be (**Fig. 6a**). The average lathe check depths for the  
 7 intended veneer thickness of 1.0 mm, 1.5 mm, and 2.0 mm were 0.28 mm, 0.41 mm, and  
 8 0.57 mm respectively (in the average depth of 28% of veneer thickness).

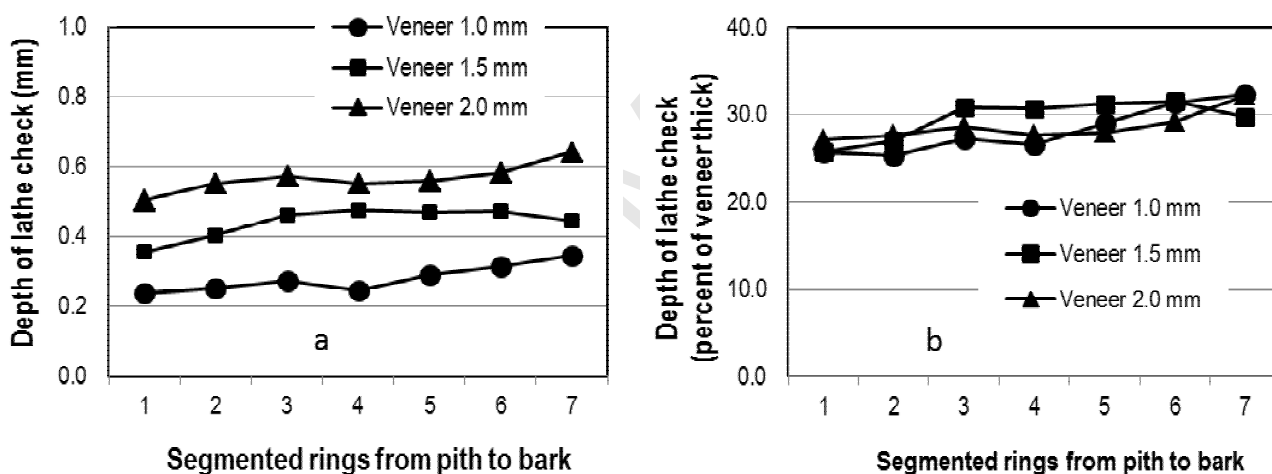

18 **Fig. 6 -** The progress of depth of lathe check from pith to bark

19  
 20  
 21 The other lathe check measured in determining veneer quality was length of lathe check.  
 22 The lengths of lathe checks tended to slightly fluctuate from the pith to the bark. The  
 23 length of lathe check follows the behavior of the depth of lathe check. The result in **Fig. 7**  
 24 indicates that the thicker the veneer peeled, the longer the lathe check will be, however  
 25 their depth and length ratio is almost the same. The average lathe check length for the  
 26 intended veneer thickness of 1.0 mm, 1.5 mm, and 2.0 mm was 0.44 mm, 0.63 mm, and

1 0.88 mm respectively. The ratios between depth and length of the lathe check were 0.64,  
 2 0.65, and 0.65 for the veneer thickness of 1.0, 1.5, and 2.0 mm respectively.

3

4 In this study the lathe checks were propagated in the same radial direction at a roughly 45°  
 5 angle to the annual ring for all veneer thickness, as shown in **Fig. 2**. It could be considered  
 6 that the surface tension generated by the unbending process during flattening the veneer  
 7 from its natural curvature would increase with veneer thickness and much more cutting  
 8 splits occurred during the peeling, and so it would generate deeper and longer length of  
 9 lathe check. During the rotary peeling of veneer for plywood or the laminated veneer  
 10 lumber manufacture, lathe checks are formed in the veneer that are as deep as 20 – 30 % of  
 11 the veneer thickness (**Rohumaa et al., 2013**). In this study the average lathe check depth  
 12 was 28% of the veneer thickness, and the ratios between depth and length of the lathe  
 13 check for all intended veneer thickness was 65%. Therefore, these results suggest that  
 14 obtaining higher glue bond strength will need to reduce the lathe check frequency rather  
 15 than the depth and the length of lathe checks.

16

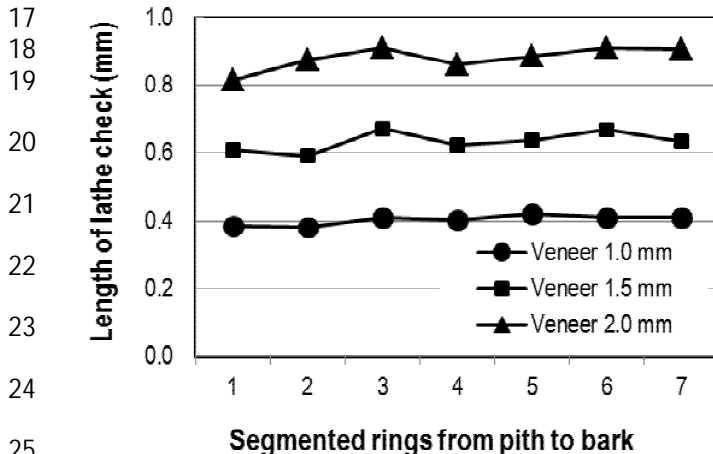

26

27 **Fig. 7 -** The progress of length of lathe check from pith to bark

### 1 3.3 Effect of lathe check on glue bond and bending strength

2 The glue bond strengths of veneer glue-line on the LVL increased from pith to bark (**Fig.**  
 3 **8**) for all veneer thickness. The results suggest that increasing proportion of veneer near  
 4 the pith would decrease the glue-line's capacity to withstand concentrated shear stresses,  
 5 thus resulting in higher amounts of glue-line failure and a reduction in percent wood  
 6 failure. However, as the proportion of veneer near bark at the tight-side glue-line  
 7 increased, percent glue-line failure decreased. This was attributed to an interaction between  
 8 the juvenility (**Fig. 8a**) and the frequency of lathe check (**Fig. 8b**). The glue bond strength  
 9 had a statistically significant, high, negative correlation to lathe check frequency, and its  
 10 correlation coefficients according to the lines in **Fig. 8b** are summarized in **Table 1**. The  
 11 results show that the regression coefficients for the glue bond strength linear equations  
 12 depicted by the veneer thickness varied from -0.814 to -1.124. These variations indicate  
 13 that the glue bond strength would decrease as the veneer thickness increase (**Table 1**).

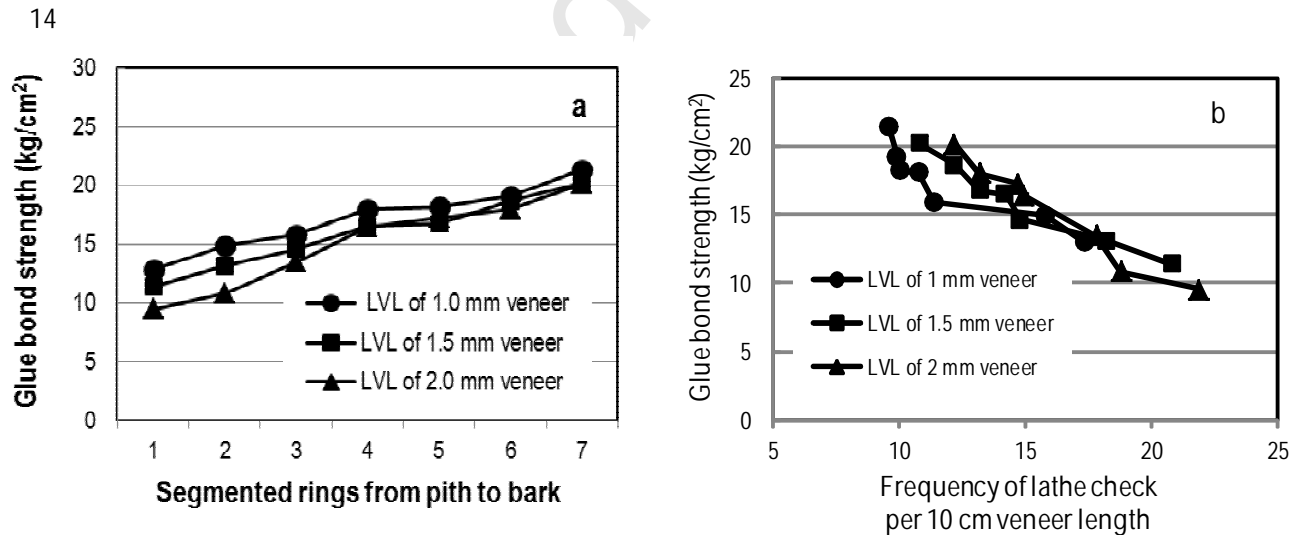

26 **Fig. 8** – The effect of juvenility and lathe check on the glue bond strength for different  
 27 veneer thickness  
 28

1 Lathe check frequency was the first variable analyzed to explain the glue bond strength.  
 2 As lathe check frequency of veneers in between the glue line increased, the amount of  
 3 "bridging" wood material between each lathe check decreases. This decrease would reduce  
 4 contact between the layers resulting in a weak glue line and low glue bond strength of the  
 5 LVL. This results are in agreement with **DeVallance et al. (2007)**, who reported that a  
 6 high frequency of lathe checks results in lower strength. Increasing veneer thickness  
 7 generally goes to a reduction of glue bond strength. We attribute this relation mainly due to  
 8 lathe checking that increases with veneer thickness, and due to higher impregnation rate of  
 9 veneers and lathe checks with glue. The LVL failures after glue bond test were observed  
 10 and evaluated visually. The specimens failed mainly along a line delineated by the  
 11 propagation of fracture of lathe checks within the veneer itself. This failure confirmed to  
 12 the observation results of **Rohumaa et al. (2013)**, in which the failure when specimens  
 13 pulled closed involved a predominantly mode II (shear) mechanism, which tends to drive  
 14 wood failure toward the loose side of veneer.

16 **Table 1** - Linear regression equations and correlation coefficients according to Fig. 8b ( $y =$   
 17 **glue bond strength,  $x =$  frequency of lathe check,  $r =$  correlation coefficient)**

Veneer thickness	Linear equation	r
1.0 mm	$y = -0,814x + 27,10$	0.90
1.5 mm	$y = -0,857x + 28,68$	0.97
2.0 mm	$y = -1,124x + 33,33$	0.98

19  
 20  
 21 The behaviors of modulus of elasticity (MOE) and modulus of rupture (MOR) from pith to  
 22 bark for sengon solid wood was published (**Darmawan et al. 2013**). It was noted in the  
 23 article that juvenile woods of sengon near pith have a significantly lower MOE and MOR

1 than the juvenile wood near the bark. The lower MOE and MOR of juvenile wood near  
2 pith are due to larger microfibril angle, and lower density. Mean MOE and MOR values  
3 from pith to bark for sengon wood reported in the study were 43651 kg/cm<sup>2</sup> and 302  
4 kg/cm<sup>2</sup>, respectively. **Martawijaya et al. (2005)** also found out that the MOE and MOR  
5 of sengon were 44500 kg/cm<sup>2</sup> and 316 kg/cm<sup>2</sup>, respectively. It was found in this study that  
6 MOE and MOR values of sengon LVLs are slightly lower compared to those of sengon  
7 solid woods. The average MOE for the sengon LVL made of 1 mm veneer thick (24-ply),  
8 1.5 mm veneer thick (14-ply), and 2 mm veneer thick (11-ply) was 42953, 40172, and 38907  
9 kg/cm<sup>2</sup>, respectively, and their average MOR was 269, 233, 216 kg/cm<sup>2</sup>, respectively.

10

11 This research approved that the MOR and MOE of sengon LVLs were lower than those of  
12 corresponding solid sengon wood. The decrease could be due to the presence of lathe  
13 checks on the sengon veneer. **Fig. 9** shows that the MOE and MOR's of all three different  
14 thicknesses (number of plies) of LVL decrease when the frequency of lathe check in the  
15 veneer is increased. Both the MOR and MOE seem to be influenced by the lathe check.  
16 Lathe check had little effect on the MOE of sengon LVL, but had more adverse effect on  
17 the MOR of sengon LVL. The results in **Fig. 9** indicated that the MOE of 11, 14 and 24 ply  
18 LVL was reduced in the average of 20.6 percent and the MOR of 11, 14 and 24 ply LVL  
19 was reduced in the average of 26.9 percent when lathe check in the veneers of LVL was  
20 increased in the amount of 5 lathe check. This suggests the lathe checks may cause a great  
21 deal of local stresses on tensile side of the bending specimen, and determine the bending  
22 failure of LVL when the lathe checks are situated under the maximum bending moment.  
23 The lack of proper connection among the fiber elements is the reason of the frequent  
24 rupture on the tensile side.

25

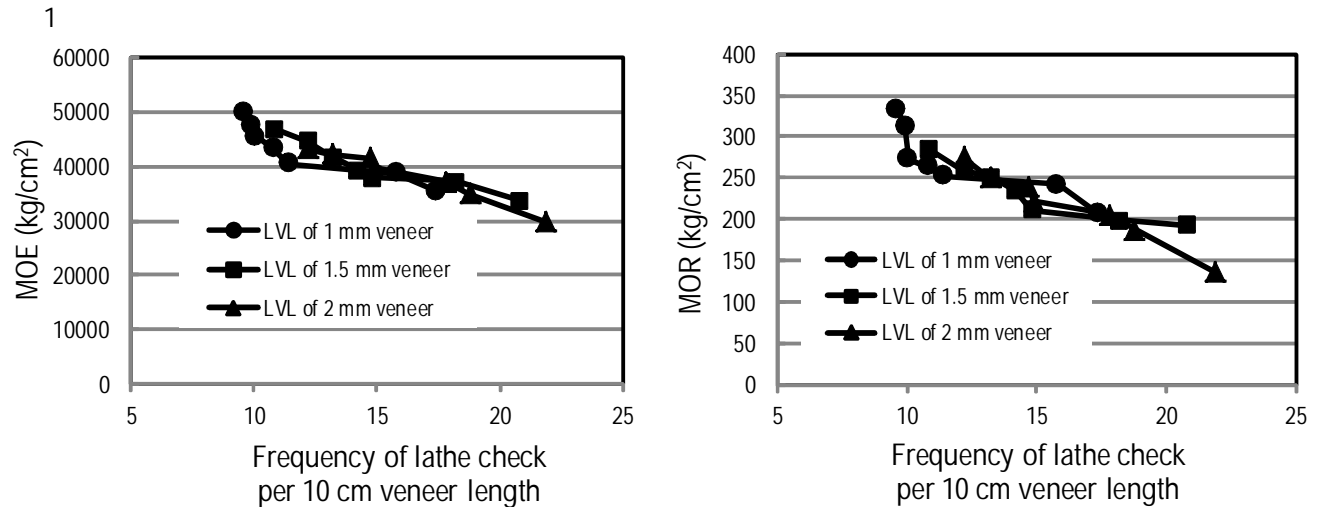

11

12

13 **Fig. 9** – The effect of lathe check on the bending strength (MOE and MOR) for different  
 14 veneer thickness

15

16

17 The results in **Fig. 10** show that both MOE and MOR increased with an increase in glue  
 18 bond strength. Though MOE are almost the same among the veneer thickness, however  
 19 MOR among veneer thickness is slightly different. As shown in **Fig. 10** the 22-ply LVL  
 20 had higher MOR compared to those of 14 and 11-ply. This is mainly due to the higher glue  
 21 bond strength produced in the glue-lines between the plies of the 22-ply which consisted of  
 22 veneers of less lathe check frequency. The thinner the veneer the higher amounts of glue  
 23 were needed in the manufacturing process resulting in better compaction of the wood  
 24 during the pressing. This strongly suggest that by using thinner veneers (higher number of  
 25 ply), the LVL will exhibit higher strength compare to those thicker veneers in production  
 26 of LVL. This finding confirms with results published by **Kilic et al. (2006)**. It was  
 27 reported in his article that the bending properties of LVL produced with thinner veneers  
 28 were higher compared to those from thicker veneers.

29

30

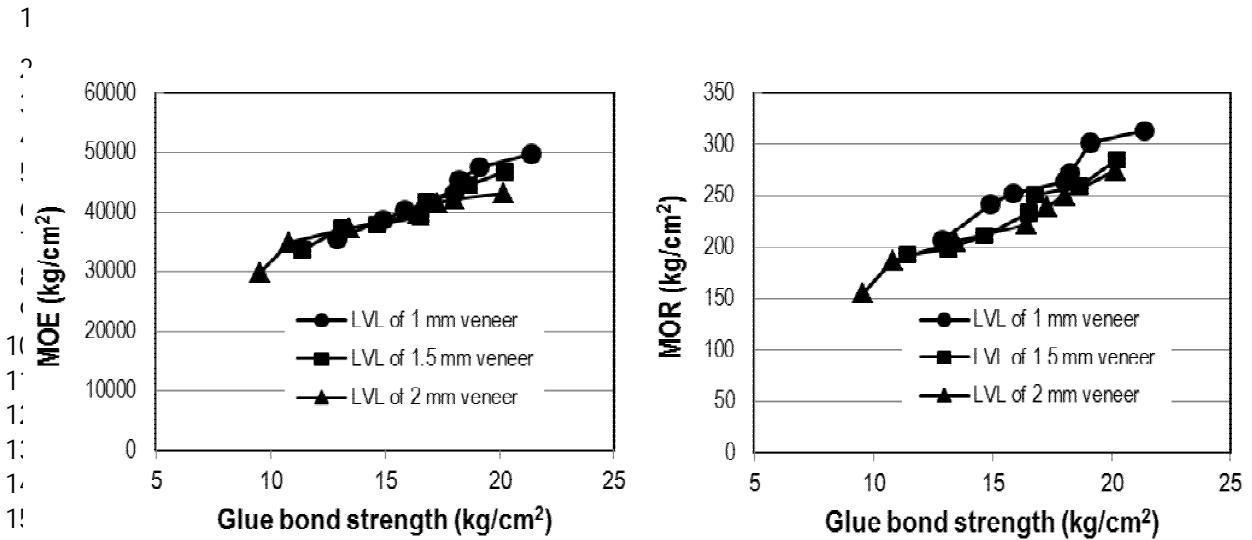

Fig. 10 - Relation between glue bond strength with MOE and MOR

#### 4. Conclusion

In conclusion, we have found that the frequency of lathe check decreased from pith to bark. The increases in boiling temperature significantly decreased the lathe check frequency of the veneers peeled from the pith to the bark. When the logs boiled in water for 8 h at 50 °C, and 4 – 8 h at 75 °C, the veneers obtained from the pith to the bark of the logs showed significantly less lathe check than those boiled for 4 h at 50 °C. The thicker veneer peeled from the logs tend to produce larger frequency of lathe check compared to thinner veneer. The MOE and MOR of sengon LVL from the bending test decreased with increasing in the lathe check frequency of the veneers. Higher glue bond strengths were also obtained for sengon LVL manufactured from veneers having lower frequency of lathe checks. The thin veneer provides better glue bond strength, MOE and MOR compared to thicker veneers. Using thinner veneers in LVL manufacture improved the strengths of the resulting panel.

1 **Acknowledgments**

2 The authors thank the Directorate for Research and Community Service of the Ministry of  
3 National Education for the Republic of Indonesia for the research grant

4

5 **References**

6

7 Acevedo, A., Bustos, C., Lasserre, J.P., Gacitua, W., 2012. Nose bar pressure effect in the  
8 lathe check morphology to *Eucalyptus nitens* veneers. *Maderas, Cienc. Tecnol.* 14 (3),  
9 289-301.

10

11 Bao, F. C., Jiang, Z. H., Jiang, X. M., Lu, X. X., Lou, X. Q., Zhang, S. Y., 2001.  
12 Differences in wood properties between juvenile wood and mature wood in 10 species  
13 grown in China. *Journal of Wood Science and Technology.* 35 (4), 363-375

14

15 Cumming, J.D., Fischer, C., Dickinson, F.E., 1969. Rotary veneer cutting characteristics of  
16 young-growth redwood. *Forest Prod. J.* 19 (11), 26-30

17

18 Cumming, J.D., Collett, B.M., 1970. Determining lathe settings for optimum veneer  
19 quality. *Forest Prod. J.* 20 (11), 20-27.

20

21 Daoui, A., Descamps, C., Marchal, R., Zerizer, A., 2011. Influence of veneer quality on  
22 beech LVL mechanical properties. *Maderas Ciencia Tecnol.* 13(1):69-83

23

24 Darmawan, W., Nandika, D., Rahayu, I., Fournier, M., Marchal, R., 2013. Determination  
25 of juvenile and mature transition ring for fast growing sengon and jabon wood. *J Indian*  
26 *Acad Wood Sci.* 10 (1), 39-47

27

28 DeVallance, D.B., Funck, J.W., Reeb, J.E., 2007. Douglas-fir plywood gluebond quality  
29 as influenced by veneer roughness, lathe checks, and annual ring characteristics. *Forest*  
30 *Prod. J.* 57 (1/2), 21-28

31

32 Dundar, T., Akbulut, T., Korkut, S., 2008a. The effects of some manufacturing factors on  
33 surface roughness of sliced Makore' (*Tieghemella heckelii* Pierre Ex A.Chev.) and rotary-  
34 cut beech (*Fagus orientalis* L.) Veneers. *Building and Environment* 43 (2008) 469–474

35

36 Dundar, T., As, N., Korkut, S., Unsal, O., 2008b. The effect of boiling time on the surface  
37 roughness of rotary-cut veneers from oriental beech (*Fagus orientalis* L.). *Journal of*  
38 *materials processing technology* 199 (2008) 119–123

39

40 Duplex, A., Denaud, L., Bleron, L., Marchal, R., Hughes, M., 2012. The effect of log  
41 heating temperature on the peeling process and veneer quality: beech, birch, and spruce  
42 case studies. *European Journal of Wood and Wood Products.* 71 (2), 63-171

43

44

45

46



- 1  
2 JAS SE 11 No. 237, 2003. Japanese agricultural standard for structural laminated veneer  
3 lumber. Japanese Agricultural Standard Association  
4  
5 Jorgensen, R. N., 1968. Steam bending of Hickory. Forest Products Laboratory, U.S.  
6 Department of Agriculture  
7  
8 Kilic, Y., Colak, M., Baysal, E., Burdurlu, E., 2006. An investigation of some physical  
9 and mechanical properties of laminated veneer lumber manufactured from black alder  
10 (*Alnus glutinosa*) glued with polyvinyl acetate and polyurethane adhesives. Forest Prod. J.  
11 (56), 56-59.  
12  
13 Kollmann, F., Kuenzi, E.W., Stamm, A.J., 1975. Principles of wood science and  
14 technology II, wood based materials. Springer Berlin Heidelberg, New York, pp. 123-132.  
15  
16 Krisnawati, H., Varis, E., Kallio, M., Kanninen, M., 2011. *Paraserianthes falcataria* (L.)  
17 Nielsen: ecology, silviculture and productivity. CIFOR, Bogor, pp 1-23.  
18  
19 Lutz, J.F., 1974. Techniques for peeling slicing, and drying veneer. USDA Forest Service  
20 Research Paper FPL 228.  
21  
22 Martawijya, A., Kartasujana, I., Kadir, K., Prawira, S., 2005. Atlas Kayu Indonesia.  
23 Forest Products Research Institute, Bogor  
24  
25 Palka, L.C., Holmes, B., 1973. Effect of log diameter and clearance angle on the peel  
26 quality of 0.125-inch-thick Douglas-fir veneer. Forest Prod. J. 23 (7), 33-41.  
27  
28 Palka, L.C., 1974. Veneer cutting review - factors affecting and models describing the  
29 process. Canadian Forestry Service, Western Forest Products Laboratory, Information  
30 Report VP-X-135, pp 1 – 54  
31  
32 Palubicki B., Marchal, R., Butaud, J.C., Denaud, L.E., Bleron, L., Collet, R., Kowaluk, G.  
33 2010. A method of lathe checks measurement: SMOF device and its software. Eur J Wood  
34 Prod 68(2):151–159  
35  
36 Rohumaa, A., Hunt, C. G., Hughes, M., Frihart, C. R., Logren, J., 2013. The influence of  
37 lathe check depth and orientation on the bond quality of phenol-formaldehyde – bonded  
38 birch plywood. *Holzforschung*, DOI 10.1515/hf-2012-0161  
39  
40 Suh, J.S., Kim, S.K., 1988. Effects of softwood log pretreatments on the veneer peeling-,  
41 drying properties and plywood properties. The Research Reports of the Forestry Research  
42 Institute. 37, 63-71  
43  
44 Tanritanir, E., Hiziroglu, S., As, N., 2006. Effect of steaming time on surface roughness of  
45 beech veneer. *Build. Environ.* 41, 1494–1497.  
46