



Science Arts & Métiers (SAM)

is an open access repository that collects the work of Arts et Métiers Institute of Technology researchers and makes it freely available over the web where possible.

This is an author-deposited version published in: <https://sam.ensam.eu>
Handle ID: <http://hdl.handle.net/10985/8899>

To cite this version :

Ivan DOBREV, Fawaz MASSOUH - Investigation of relationship between drag and lift coefficients for a generic car model - In: BULTRANS-2014, Bulgaria, 2014-09-17 - BULTRANS-2014 Proceedings, Sozopol - 2014

Any correspondence concerning this service should be sent to the repository

Administrator : scienceouverte@ensam.eu



INVESTIGATION OF RELATIONSHIP BETWEEN DRAG AND LIFT COEFFICIENTS FOR A GENERIC CAR MODEL

IVAN DOBREV

Laboratoire de mécanique des fluides, ENSAM, Paris, France
ivan.dobrev@ensam.eu

FAWAZ MASSOUH

Laboratoire de mécanique des fluides, ENSAM, Paris, France
fawaz.massouh@ensam.eu

Abstract:

The paper presents a study of aerodynamic characteristics of a car, which has the simplified geometric shape, so-called Ahmed body. Flow around the body and the influence of its rear slant angle on drag are widely studied by numerous researchers. However, small number of studies treats the relationship between drag and lift and this phenomenon is not fully understood. To clarify the relationship between lift and drag, experiments are conducted in the wind tunnel of ENSAM - Paris. The study is carried out for different rear slant angles in order to determine how the drag coefficient varies with lift. The results of experiments are completed by numerical simulations, which permit to obtain the detailed flow field around Ahmed body and to understand better the effect of rear slant angle on drag and lift coefficients.

Keywords: *aerodynamics, helicopters, rotor wake.*

1. Introduction

The aerodynamics of road vehicle is object of numerous experimental study and simulations because the aerodynamic forces are important factor for fuel saving and vehicle stability. Generally, the industrial research is carried out on real scale vehicle because the Reynolds number. However, in their study the researchers used the simplified geometry models, which permit to show the influence of the general form of the vehicle on aerodynamic characteristic. There exist several geometric forms, but the most studied model of generic car is proposed in ref. [1] by Ahmed. This is a so-called Ahmed body, which is a very simple bluff body composed by three parts: front end, central part and rear end, fig 1. The authors [1] measure the total drag and separately the drag of front end, slanted rear end and vertical rear end base. The obtained results show that drag depends dramatically on the slant angle of the rear end. The study is carried out for 10 different slant angles, from 0° to 40° . The minimum of the drag is found to be at 12.5° , the maximum is reached at 30° , and then abruptly drops for high angles, where the flow is detaches. Additionally, the authors study the wake behind the

body and found four horseshoe systems, which existence and strength depend on the slant angle, [1, 2]. Unfortunately, the information about the lift coefficients is not presented. There are increasing number of papers, which studies the Ahmed body but few are interested in the influence of lift on lift on drag, [3-9]. In these papers, the authors present simultaneously the lift and drag coefficients usually for slant angle of 25° . Therefore, it is interesting to show how the lift and drag coefficients vary for slant angles from 0° to 90° .

The main purpose of this paper is to elucidate the influence of lift on drag when the slant angle varies. The study is carried out experimentally and by means of numerical simulation. The obtained results will be helpful for the drag reduction and for simulation validation.

2. Experimental setup

The experiments are carried out in the wind tunnel of ENSAM-Paris, fig. 1. This wind tunnel is of a closed-circuit type and has a three-blade axial fan with a rotor diameter of 3 m. The fan is driven by a frequency-controlled asynchronous motor with a power of 120 kW. The flow is homogenized in a

settling chamber, which is equipped with honeycomb strengtheners and wire mesh. The tunnel nozzle accelerates the wind from settling chamber to test section up to 40 m/s. The nozzle has contraction ratio of 12.5, ensuring a uniform velocity profile with a turbulence ratio of less than 0.25%. The semi-guided test section has a cross-section of 1.35 m × 1.65 m and a length of 2 m. The static pressure in the test section is equal to atmospheric pressure. Hence, the upstream velocity only depends on the stagnation pressure in the settling chamber, which is measured by a pressure transducer (Furness Control FC20).



Fig. 1 Wind tunnel test section with Ahmed body

The wind tunnel is equipped with two balances that are linked one to another, fig 2. The first balance is a six-component and can measure up to 1500N with a precision of 0.075N. The balance is equipped with special cantilever beam, which measures the components of the force and moment vectors separately. The second balance can measure four components: lift, drag, pitch and roll. This balance has a precision of 0.01N in the interval of 0N to 50N.

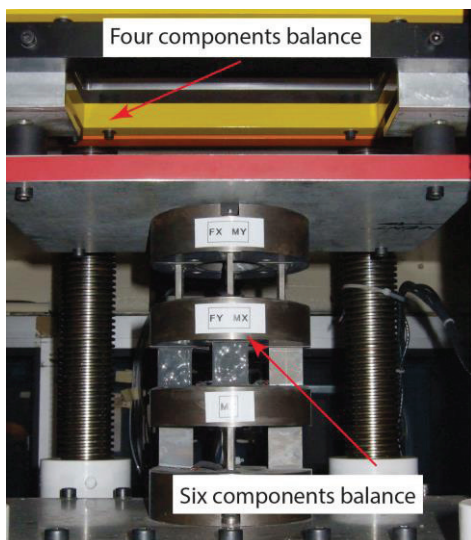

Fig. 2 Wind tunnel balance

The balances are connected to a data acquisition

system HBM MGCPlus, which is equipped with high quality strain gauges amplifiers and analog to digital converters. The acquisition system is connected with PC and controlled by a Labview program.

In this study, we use Ahmed body presented in fig. 3, which is smaller than the original. Because the length of the wind tunnel test section is limited, the scale factor is 3/4. In order to avoid the influence the wind tunnel boundary layer, the model is laid on special ground plate with a diameter of 1.5m.

The Ahmed body is installed on the 4-components balance for measurements of drag and lift forces. Depending on slant angle, from 25° up to 90°, the flow becomes highly unsteady and aerodynamic force on the body vary with time. The flow visualization with of helium-filled bubbles in the case of 90° shows a strong detachment, fig. 4.

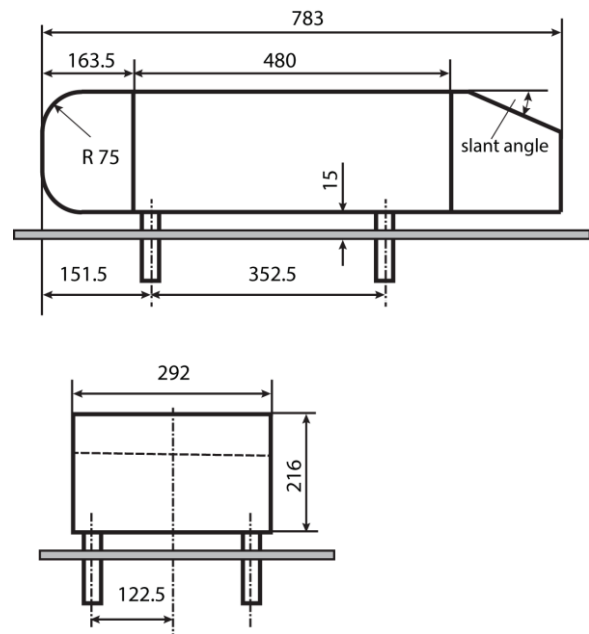

Fig.3 Ahmed body

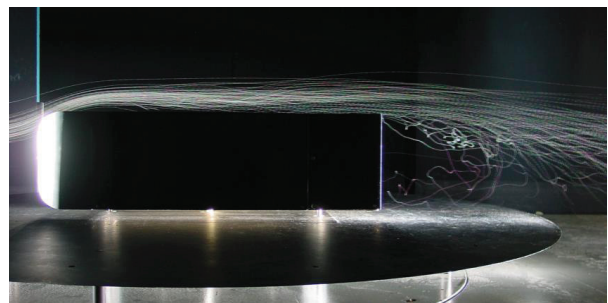

Fig.4 Flow detachment for 90° slant angle (ENSAM wind tunnel)

To obtain the average value, the measurements are conducted during a time interval of 180s with sampling rating of 10Hz. The experiments show that the time interval longer than 180s do not changes the results. The lift C_L and drag C_D coefficients are

calculated as follows:

$$C_L = \frac{F_z}{\frac{\rho V^2}{2} S}; \quad C_D = \frac{F_x}{\frac{\rho V^2}{2} S} \quad (1)$$

Here ρ is air density, V is upstream velocity and S is cross section of Ahmed body.

3 Experimental results

All experiments are carried out for upstream velocity of 30 m/s, therefore the Reynolds number is 2.66 times smaller than the Reynolds number in study presented in [1]. For this condition, the drag coefficient becomes greater as is mentioned in [3, 9]. The obtained results for lift and drag coefficients are presented on fig. 5 for 11 slant angles of 0°, 10°, 15°, 20°, 25°, 27°, 28°, 29°, 30°, 45° and 90°.

The study confirms the previously published results for the drag, [3]. The minimum of the drag is reached for slant angle of 15°, when the lift is zero. The maximum of lift is for slant angle of 29° and for this angle, the drag reaches its maximum value. It must be noted that the increasing of slant angle, from 25° to 29°, leads to increasing of the drag with 30%. When the slant angle becomes 30°, the flow detaches from rear-end and as results the lift force becomes smaller. In this case, the drag is close to the drag for other slant angles when the flow detachment occurs.

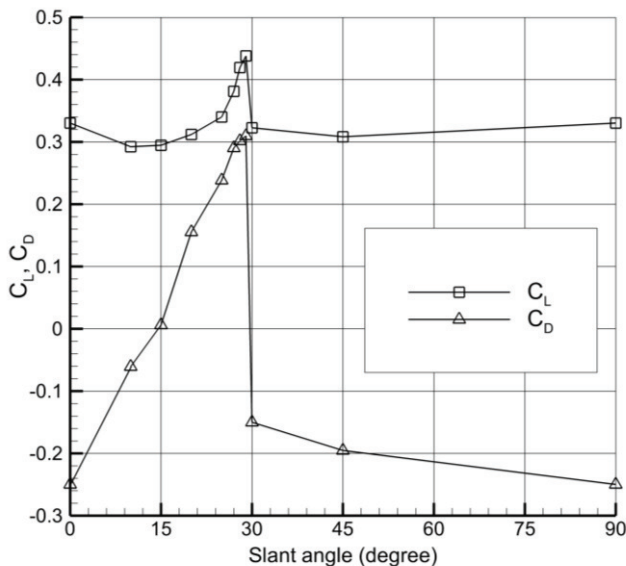

Fig.5 Lift and drag coefficient of Ahmed body depending on slant angle

The variation of the lift with increasing of slant angle is linear from 0° to 29°. When the flow detaches from the slanted surface, the lift and the drag varies insignificantly. The lift is negative, because the flow between the ground plate and the body accelerates, as

result the bottom pressure becomes smaller than top pressure.

The results of this study show the strong dependence of the drag from lift. However, this dependence is not easy to explain and quantify, as in the case of the wing, because the aspect ratio of Ahmed body is very low and the body is very close to the ground.

4. Numerical Simulation

The flow around the Ahmed body is still difficult to calculate [10]. In presented study, the numerical solution is carried out by means of CFD Ansys Fluent 15.0. The multi-block structured grid, which is created with Gambit 2.4.2, contains more than 280 blocks. After importing in Fluent, the grid is adapted two times consecutively near the wall boundary. As results the body surface contains more than 3 million elements, which permits to obtain dimensionless wall distance y^+ lower than 2. In total, the grid contains 45 million hexahedral cells.

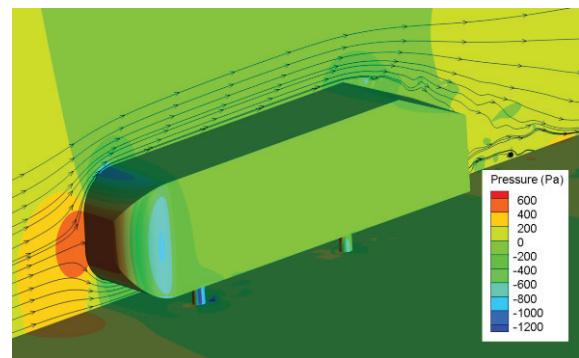

Fig.6 Pressure distribution for slant angle of 25°.

The calculation is unsteady with time step of 0.01s. The boundary conditions correspond to the experiment. The turbulence model is hybrid - Improved Delayed Detached Eddy Simulation (IDDES). This kind of modeling improves significantly the results in the case of flow separation, but is very time consuming and needs one-week calculation on computer with 2x8 cores.

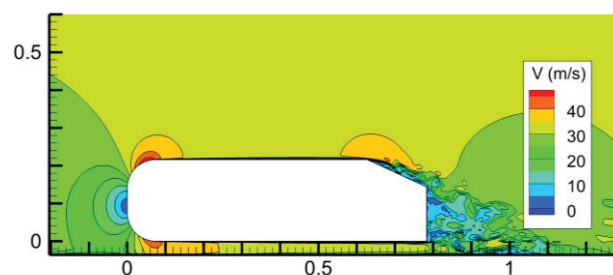

Fig.7 Velocity distribution for slant angle of 25°.

The calculations are conducted for slant angles of 25° and 90°. The result for pressure distribution on the Ahmed body surface is presented in fig. 6. The velocity and vorticity distribution on the symmetry plane is presented in fig. 7 and 8. For slant angle of 25°, the flow becomes highly unsteady and the drag force varies significantly with time. However, the flow is not separated from the slanted surface, but it becomes very turbulent. The drag and lift are averaged from 20s time steps. The results are presented in tab. 1 and shows good agreement with experiment.

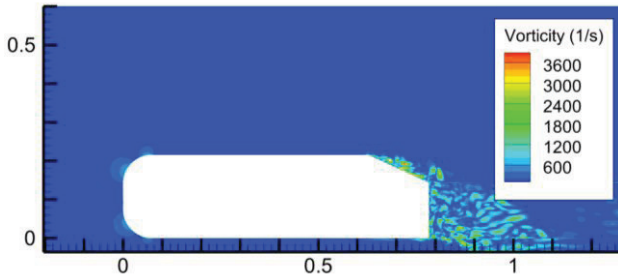

Fig.8 Vorticity distribution for slant angle of 25°.

Tab. 1

Coefficient	Experiment	CFD
C_L	0.224	0.241
C_D	0.32	0.305

5. Conclusion

The paper presents a study of Ahmed body for 11 different slant angles. The flow around the body, the lift and the drag significantly depends on slant angle. From 0° up to 29° the lift growth is linear, from negative to positive value. For slant angles of 30° the flow separates and the lift becomes again negative. Beyond the slant angle of 30°, the lift and drag become nearly constant. The drag has a minimum at 15°, when the lift is close to zero and then becomes 50% greater for 29° when the lift reaches its maximum.

The results of experiments are completed by numerical simulations, which permit to obtain the detailed flow field around Ahmed body and to

understand better the effect of rear slant angle on drag and lift coefficients. The simulations are in good agreement with experiments but need detailed comparison with results from particle image velocimetry.

References

- [1] S. R. Ahmed, G. Ramm and G. Faltin, Some salient features of the time-averaged ground vehicle wake (No. 840300). SAE Technical Paper, 1984
- [2] W. H. Hucho, Aerodynamics of road vehicle, SAE Inc, Warrendale, Pa., 4 ed, 1998.
- [3] Graysmith, A. J., et al, Comparisons between CFD and experimental results for the Ahmed reference model, RAeS Conference on Vehicle Aerodynamics, 1994.
- [4] R. K. Strachan, K. Knowles and N. J. Lawson. "The vortex structure behind an Ahmed reference model in the presence of a moving ground plane." Experiments in fluids vol 42(5), 2007, pp.659-669.
- [5] J. F. Beaudoin, J. L. Aider, Drag and lift reduction of a 3D bluff body using flaps, Experiments in fluids, vol.44(4), 2008, pp. 491-501.
- [6] R. K. Strachan, N.J. Lawson, N. J. and M. V. Finnis, Force and moment measurements for a generic car model in proximity to a side wall, Proceedings of the Institution of Mechanical Engineers, Part D: Journal of automobile engineering, 2012.
- [7] G. Fourrié, L. Keirsbulck, L., Labraga, and P. Gilliéron, Bluff-body drag reduction using a deflector, Experiments in Fluids, 50(2), 2011, pp. 385-395.
- [8] A. Thacker, S. Aubrun, A. Leroy, and P. Devinant, Effects of suppressing the 3D separation on the rear slant on the flow structures around an Ahmed body. Journal of Wind Engineering and Industrial Aerodynamics, 107, 2012, pp. 237-243.
- [9] H. Fukuda, K. Yanagimoto, H. China, and K. Nakagawa, Improvement of vehicle aerodynamics by wake control, JSAE review, 16(2), 1995, pp.151-155.
- [10] W. Meile, G. Brenn, A. Reppenhagen, and A. Fuchs, Experiments and numerical simulations on the aerodynamics of the Ahmed body, CFD Letters, 3(1), 2011, pp. 32-39.